

MAXvent 2 medium pressure axial fans

With energy-saving IE2 motor

04/2011



Copyright © Ziehl-Abegg FMV 2011

ZIEHL-ABEGG FMV reserves the copyright of this catalogue in its entirety. This catalogue is meant for your own use only, and must not be forwarded to third parties without our written consent. The contents of this catalogue, including parts thereof, may not be published. ZIEHL-ABEGG FMV reserves the right to make any technical specification changes without prior notice. The information and data contained within this catalogue have been compiled to the best of our ability. The responsibility for checking the suitability and correct application of the products shown in this catalogue remains with the user.

ZIEHL-ABEGG FMV réserve les droits d'auteur de ce catalogue dans son intégralité. Ce catalogue est destiné à un usage personnel, il ne doit pas être communiqué à un tiers sans notre accord écrit. Le contenu de ce catalogue ne peut pas être publié, même partiellement. ZIEHL-ABEGG FMV se réserve le droit de faire tous les changements techniques de spécifications sans avis préalable. L'information et les données contenues dans ce catalogue ont été compilées au mieux. La responsabilité de vérifier l'adéquation et l'utilisation correcte des produits de ce catalogue appartient à l'utilisateur.

Das Urheberrecht des Katalogs liegt für den gesamten Inhalt ausschließlich bei ZIEHL-ABEGG FMV. Der Katalog ist zur Nutzung für Ihren Bedarf bestimmt und darf ohne unsere ausdrückliche schriftliche Zustimmung weder an Dritte weitergegeben, noch deren Inhalte, auch auszugsweise, veröffentlicht werden. Die im Katalog enthaltenen Informationen und Daten sind nach bestem Wissen erstellt und entbinden Sie nicht von der Pflicht, die Eignung der darin enthaltenen Produkte auf die von Ihnen beabsichtigte Anwendung hin zu prüfen. ZIEHL-ABEGG FMV behält sich alle Technische Änderungen vor.

La compañía ZIEHL-ABEGG FMV se reserva los derechos de autor de este catálogo en su integralidad. Este catálogo está destinado a un uso personal y no debe ser comunicado a terceros sin nuestro acuerdo escrito. El contenido de este catálogo no puede ser publicado ni tan siquiera parcialmente. La compañía ZIEHL-ABEGG FMV se reserva el derecho de introducir cambios técnicos de especificaciones sin aviso previo. La información y los datos contenidos en este catálogo han sido compilados en su mejor estado. La responsabilidad de comprobar la adecuación y la utilización correcta de los productos de este catálogo pertenece al usuario.

ZIEHL-ABEGG FMV riserva i diritti d'autore di questo catalogo nella sua integralità. Questo catalogo è destinato ad un uso personale, non deve essere comunicato ad un terzo senza il nostro accordo scritto. Il contenuto di questo catalogo non può essere pubblicato, anche parzialmente. ZIEHL-ABEGG FMV si riserva il diritto di apportare tutte le modifiche delle specifiche tecniche senza alcuna comunicazione preliminare. Le informazioni ed i dati contenuti in questo catalogo sono state compilate al meglio. La responsabilità di verificare la conformità e l'uso corretto dei prodotti di questo catalogo spetta all'utilizzatore.

Ziehl-Abegg, a progressive company with Tradition

Those who want the best trust in Ziehl-Abegg. Wherever a lift is moving, or buildings or facilities are air conditioned, it's often Ziehl-Abegg's latest technology which is to be found playing its part.

In 1910, Mr. Emil Ziehl established the foundations which enable Ziehl-Abegg's present market leading position in the lift drive motor market sector, as well as the ventilation and air conditioning market sector.

In 1949 after the war, Ziehl-Abegg OHG was newly founded in Kuenzelsau by the brothers Heinz and Guenter Ziehl.

Ziehl-Abegg has always possessed the critical expertise and knowledge required to enable the transfer of technology from one market sector to another, and to understand and respond to customers' needs and requirements. This has resulted in Ziehl-Abegg having a head-start in the market, which continues to this day.

More than 2500 employees are working for Ziehl-Abegg worldwide. Today, nearly a century after Emil Ziehl's pioneering work, the company continues delivering advanced technology in the fields of air movement, motors and motor drives, and electrical controls, from Kuenzelsau to the whole world. In most countries throughout the world, we are represented locally.

With a wide range of top quality products, we offer tailored system solutions to our customers, all from one source. From the beginning to the end, Ziehl-Abegg customers are offered guidance and support in all phases of their projects.



Ziehl-Abegg headquarters, Kuenzelsau



Ziehl-Abegg Medium pressure fan production, Villieu

Energy saving IE2 motor is the new standard for MAXvent2

New energy laws and impending regulations in the EU on minimum efficiencies require significant energy consumption reductions in air conditioning systems. Directive 2005/32/EC with regard to ecodesign requirements for electric motors will introduce minimum efficiencies for such motors starting June 16th, 2011. This means that throughout Europe, solely energy-saving motors will be permitted for use in new plants.

In anticipation to the EU regulation and starting April 2011, Ziehl-Abegg will supply MAXvent 2 Medium Pressure Axial Fans with IE 2 motors. The IE2 system will be offered without extended delivery times, and at a price which is only minimally higher than the previous systems with IE1 motors allowing a very fast pay back.

In addition to the cost savings enjoyed by users, the environment will also benefit from the reduced energy requirements. At about 160,000 kWh of power to drive motors per year, using IE2 motors can prevent up to 20,000 tons of CO₂.

Use the energy-saving potential

IE2 motors, when compared with IE1 motors, offer efficiency improvements of up to 10%. In total cost calculations for motor-driven ventilation systems over a ten year period, the cost proportion for energy is more than 90%. By using energy-efficient class IE2 motors, energy losses are reduced by up to 30% and as a consequence, energy cost savings can be realised, when compared with IE1 products.

At an energy price of 0.11 €/kWh, running a 7.5 kW, 4-pole IE2 motor rather than an IE1 motor, can save 34€ per 1 000 operating hours. While continuous operation of the fan almost 300€ of energy costs can be saved per year.

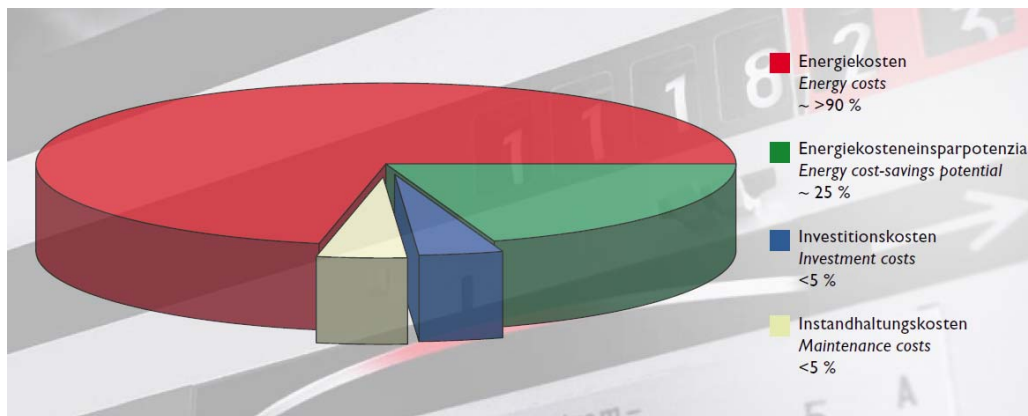

Cost distribution across 10 years Nature does not waste energy - neither do we! Example calculation for energy savings

Motor 7.5 kW, 4 pole

IE1 motor h = 87 %
Pinput = 8.62 kW
Ploss = 1.12 kW

IE2 motor h = 90.2 %
Pinput = 8.31 kW
Ploss = 0.81 kW

Energieeinsparung
Motor 7,5 kW, 4-polig
Energy savings
Motor 7.5 kW, 4 pole

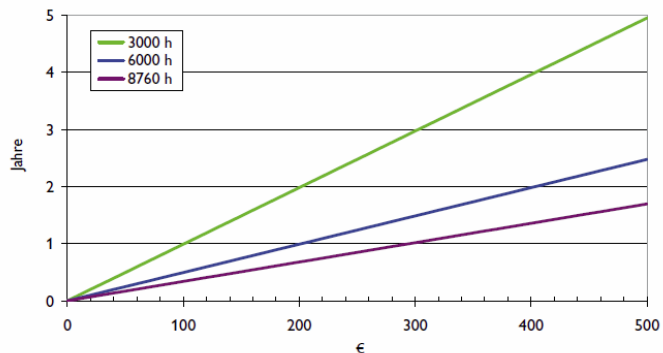

Efficiency difference (only) 3.2 % \approx 27 % lower loss



REFRIGERATION
Coolers, Condensers,
Chillers,
Blast and spiral freezers,
Radiators, Oil coolers,

REFRIGERATION
Ventilateurs,
Condenseurs, Refroidisseurs,
Congélateurs à spirale, soufflant
Radiateurs, Refroidisseurs d'huile

KÄLTETECHNIK
Kühler, Verflüssiger,
Kaltwassersätze, Froster,
Ölkühler, ect

REFRIGERAZIONE
Ventilatori,
Condensatori, Raffreddatori, Congelatori
a spirale, termoventilatori,

REFRIGERACIÓN
Ventiladores,
Condensadores,
Refrigeradores,
Congeladores de
espiral, sopladores,
Radiadores,



AGRICULTURE, FOOD
Grain and rice dryers, forage
Preservation of vegetables, fruits,
flowers, pasta

AGRICULTURE, AGRO-ALIMENTAIRE
Séchage de céréales, fourrage...
Ventilation pour la conservation de légumes, de fruits, de fleurs...
Séchage des pâtes, riz

AGRICULTURA, ALIMENTACIÓN
Secado de cereales, forraje...
Ventilación para la conservación de verduras, fruta, flores...
Secado de pastas, arroz

AGRICOLTURA, AGRO-ALIMENTARE
Essiccamento di cereali, forag-
gio...
Ventilazione per la conservazione
di verdure, frutta, fiori...
Essiccamento di pasta, riso



LANDWIRTSCHAFT, LEBENSMITTELBEREICH
Trocknen von Getreide und Heu...
Gebläse für die Lagerung von Gemüse, Obst, Blumen...
Trocknen von Nudeln, Reis



INDUSTRIE
Séchage du bois, papier, textile,
Extraction ou introduction d'air
Refroidissement de moteurs

INDUSTRY
Wood dryer, paper, textiles,
Air extraction or introduction
Engine cooler



INDUSTRIA
Secado de madera, papel, textil
Extracción o introducción de aire
Refrigeración de motores

INDUSTRIA
Essiccamento del legno, carta, tessuti,
Estrazione o introduzione dell'aria
Raffreddamento dei motori

INDUSTRIE
Trocknen von Holz, Papier, Stoffen
Luftentzug oder -versorgung
Motorkühlung, Kühlung von Transformatoren



Integration into a ventilation duct

Einbau in ein Rohrsystem

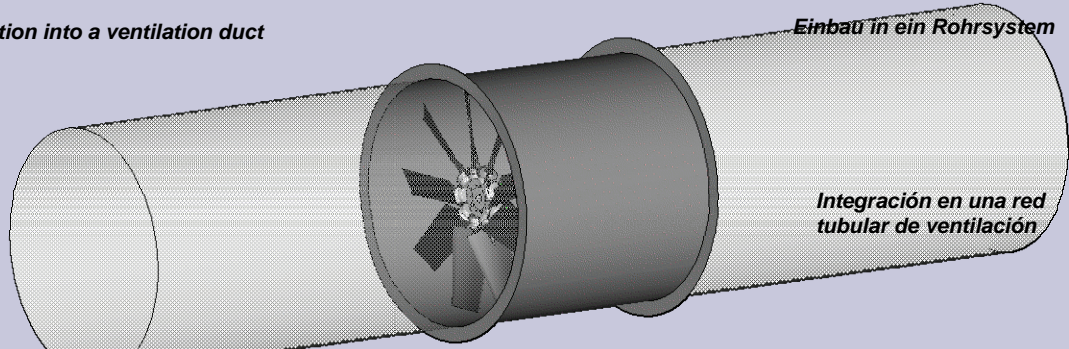

Integración en una red tubular de ventilación

Intégration dans un réseau tubulaire de ventilation

Integrazione in un sistema tubolare di ventilazione

Selection		7
English Technical Documentation		8
Documentation technique Française		12
Deutsche technische Dokumentation		16
Documentación técnica española		20
Documentazione tecnica Italiano		24
Standard temperature range : -30°C / +50°C		28
FV31	2/4 poles / pôles / polig / polos / poli	29
FV35	2/4 poles / pôles / polig / polos / poli	31
FV40	2/4/6 poles / pôles / polig / polos / poli	33
FV45	2/4/6 poles / pôles / polig / polos / poli	36
FV50	2/4/6 poles / pôles / polig / polos / poli	39
FV56	2/4/6 poles / pôles / polig / polos / poli	42
FV63	2/4/6/8 poles / pôles / polig / polos / poli	45
FV71	4/6/8 poles / pôles / polig / polos / poli	49
FV80	4/6/8 poles / pôles / polig / polos / poli	52
FV90	4/6/8 poles / pôles / polig / polos / poli	55
FV10	4/6/8 poles / pôles / polig / polos / poli	58
FV12	4/6/8 poles / pôles / polig / polos / poli	61
FV14	6/8 poles / pôles / polig / polos / poli	64
Increased Temperature Range : -30°C / +60°C		66
FV31	2/4 poles / pôles / polig / polos / poli	67
FV35	2/4 poles / pôles / polig / polos / poli	69
FV40	2/4/6 poles / pôles / polig / polos / poli	71
FV45	2/4/6 poles / pôles / polig / polos / poli	74
FV50	2/4/6 poles / pôles / polig / polos / poli	77
FV56	2/4/6 poles / pôles / polig / polos / poli	80
FV63	2/4/6/8 poles / pôles / polig / polos / poli	83
FV71	4/6/8 poles / pôles / polig / polos / poli	87
FV80	4/6/8 poles / pôles / polig / polos / poli	90
FV90	4/6/8 poles / pôles / polig / polos / poli	93
FV10	4/6/8 poles / pôles / polig / polos / poli	96
FV12	4/6/8 poles / pôles / polig / polos / poli	99
FV14	6/8 poles / pôles / polig / polos / poli	102
Accessories / Accessoires / Zubehör / Accesorios / Accesori		104
Axial Fan Definition		107



ISO 9001:2000



GOST

Quick selection:
Air-flow / Static Pressure

Sélection rapide:
Débit / pression statique

Schnellauswahl:
Volumenstrom/ Statischer Gesamtdruck

Selección rápida:
Caudal / Presión estática

Selezione rapida:
Portata / pressione statica

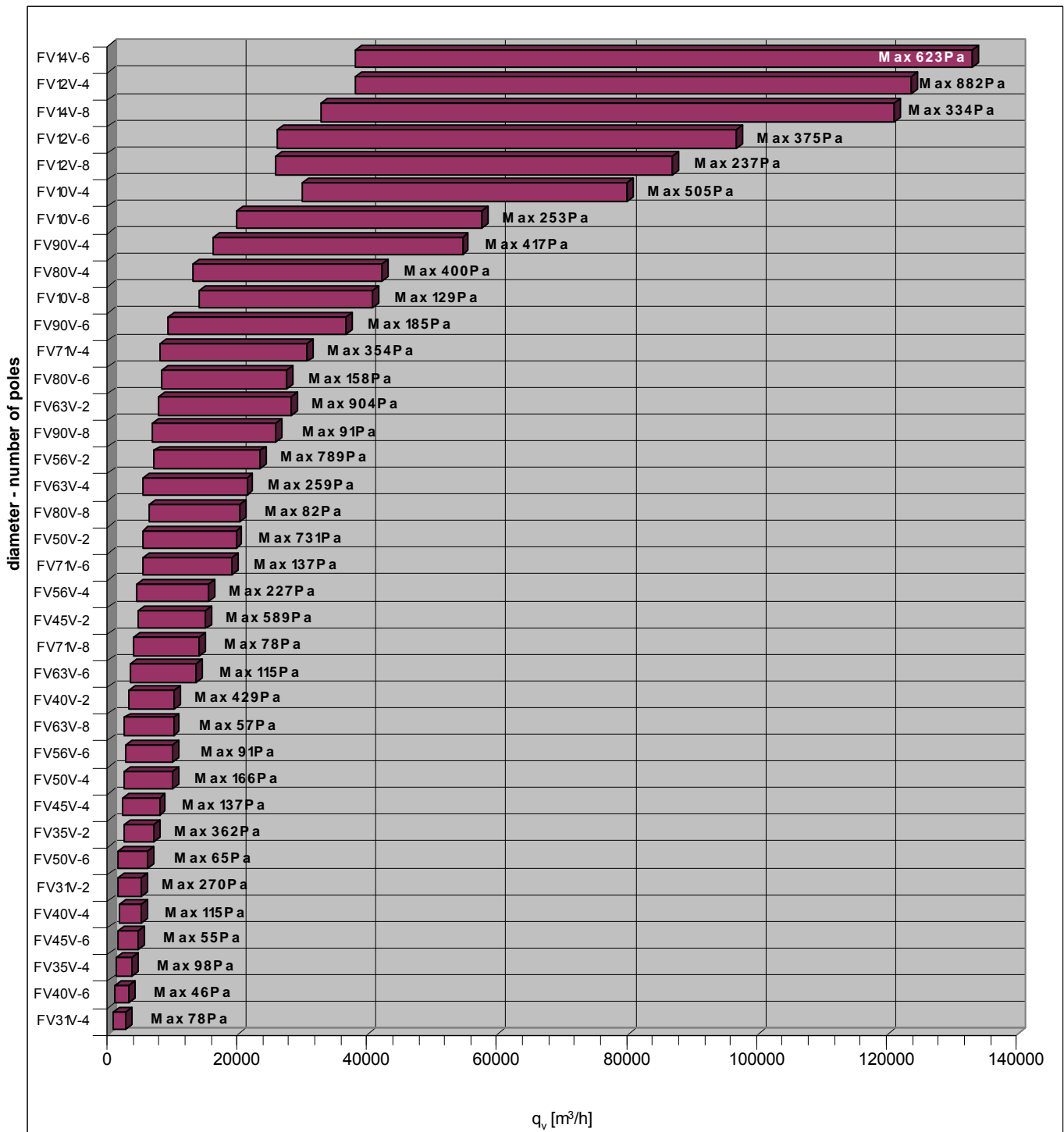



The MAXvent 2 Range

The MAXvent 2 range is the evolution of a proven existing axial medium pressure range, in response to the actual market requirements in terms of aeraulic performances, low noise level and breadth of range.

We offer two configurations in standard, short and long casing designed to the EUROVENT standard dimensions. Thanks to the efficient design and proven components, we can ensure the high quality and reliability of the MAXvent 2 range of fans.

We have been working countless hours and still are, in order to improve day after day our range of fans and bring you the best performances and highest reliability. Answering your technical requirements and needs is our goal.

Technical description

The axial MAXvent 2 range fans are constructed with impellers made of glass reinforced polyamide blades (PAG) and aluminium alloy hubs. These impellers have been designed for applications needing products capable of working at a total pressure of 1000 Pa. According to the pressure drop of your application, diameter and speed of the selected fan, available airflow goes up to 130 000 m³/h.

Airflow measurements are done according to ISO 5801 standard

A wide range:

The MAXvent 2 axial range fans are available in 13 diameters:

315, 355, 400, 450, 500, 560, 630, 710, 800, 900, 1000, 1250 and 1400 mm.

MAXvent 2 axial range fans are constructed with standard asynchronous internal rotor motors, conforming to the IEC standards. These motors are a B3 type of construction, IP55 and class F, with PTC thermistors.

They are available in three-phase 230/400V 50Hz up to 2,2kW and 400VΔ above.

Depending on the diameter, the motors are available in 2, 4, 6 or 8 poles configurations.

For each diameter and each speed of rotation, the range includes 5 impeller blade angles – a total of almost 185 possible combinations to satisfy any request:

Ø	2 poles	4 poles	6 poles	8 poles
315	√	√		
355	√	√		
400	√	√	√	
450	√	√	√	
500	√	√	√	
560	√	√	√	
630	√	√	√	√
710		√	√	√
800		√	√	√
900		√	√	√
1000		√	√	√
1250		√	√	√
1400			√	√

Depending on your requirements, we propose to you several constructions: either short casing, long casing or square plate with specific dimensions, for installation in ducted systems or for use with industrial processes.

All the components in the MAXvent 2 range are protected against corrosion and can be painted on request.

Standard Configurations

The MAXvent 2 standard versions are constructed with:

- Impellers made with glass reinforced polypropylene blades, selected by us for your application and balanced according to IEC 1940 standard (G = 6.3)
- IEC-IE2 B3 lug-mounted motors, SIEMENS or similar brand (cable gland not supplied)
- Steel Casings.

The fans are supplied on pallets

There are two anti-corrosion finishes:

- Pre-galvanized steel
- Hot dip galvanized steel

These fans can operate either horizontally or vertically and are available in both airflow directions.

The fans are directly coupled: the impeller is mounted directly on the motor shaft.

In the standard configuration, they can be used in any application with clean air in a dust free environment.

The temperature of the airflow should be between –30 °C and +50 °C for fans in the “Standard temperature range” section and between –30 °C and +60°C for fans in the “Increased Temperature Range” section.

Accessories:

Speed controllers, mounting feet, Anti-vibration mounts, matching flanges, inlet bell mouth, flexible connector, protective grilles (impeller or motor side).

Special Configurations

Ziehl-Abegg FMV can offer special configurations which answers specific needs, such as:

- Square plate design for all diameters, with dimensions adapted to the application.
- Stainless steel 304 or 316L or polyester powder paint finish
- Impeller with aluminium blades or glass reinforced polypropylene blades (PPG)
- Motor
 - 2 speeds (star/delta or Dahlander)
 - 60Hz
 - PTO thermistors
 - High or low temperatures
 - Terminal box remotely mounted on the casing
 - All IEC motors options
 - And many other possibilities

We study any request concerning non standard products.

...Don't hesitate to ask us!



The MAXvent 2 Range

Explanation

- 1 Fan
- 2 Air Flow
- 3 Fan static pressure
- 4 Pitch angle
- 5 Frequency
- 6 Motor size
- 7 Voltage
- 8 Current
- 9 Rated power
- 10 Rated speed
- 11 Suction side sound pressure level @ 3m
- 12 Design
- 13 Relative sound power level spectrum
- 14 Accessories
- 15 Temperature range

FV31V-2D _____

50Hz	Motor	U	I	P ₂	n
V	A	kW	min ⁻¹		
25°	71 M	400	1	0,37	2740
30°	71 M	400	1	0,37	2740
35°	71 M	400	1,36	0,55	2800
40°	71 M	400	1,36	0,55	2800
45°	80 M	400	1,73	0,75	2855

Pitch Angle	Relative spectrum						
	63	125	250	500	1000	2000	4000 8000
25°	-42	-33	-15	-7	-4	-6	-11 -20
30°	-41	-32	-15	-7	-4	-6	-10 -19
35°	-40	-31	-15	-7	-4	-5	-9 -18
40°	-40	-31	-15	-7	-4	-5	-9 -17
45°	-39	-30	-16	-8	-4	-5	-8 -17

Accessories: see pages 100-102

Standard Temperature Range : -30°C / +50°C

Designation

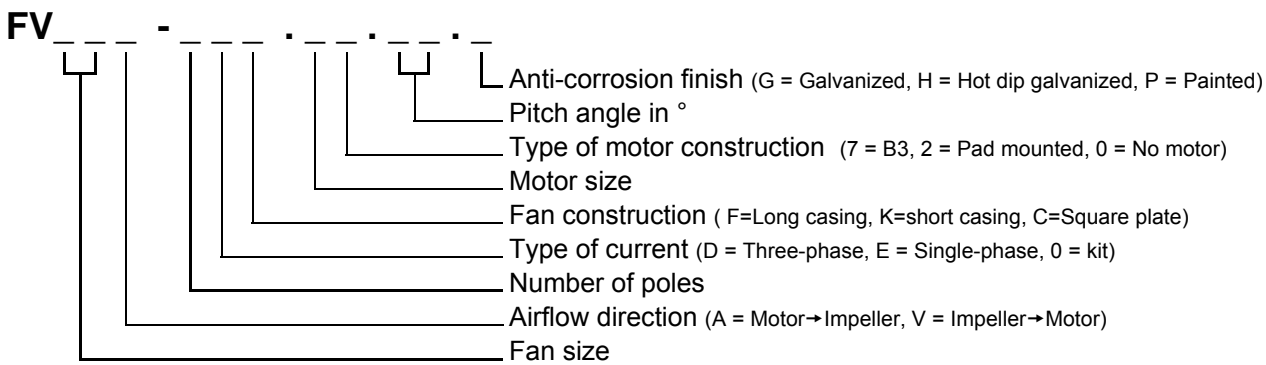



The MAXvent 2 Range

Aeraulic measurements:

Fan characteristic curves show a Δp_{sf} pressure increase in Pa as a function of airflow in m^3/h

Aeraulic tests were conducted as per ISO5801 in our laboratories ("Invent" laboratory in Germany and ZA-FMV laboratory in France).

A complete set of measurements taken in our laboratories enabled us to establish the curves presented below.

Measurements were taken in type A, with long casing, with full bellmouth and without safety guard.

Some tests were corroborated by the CETIAT (approved French laboratory)

The fan is installed in a measurement box with free intake and outflow.

Acoustic measurements:

Acoustic tests were conducted as per ISO13347.

Acoustic powers with A weighting in L_w are calculated from acoustic pressure levels in octave bands measured at the suction side of the fan.

Sound level pressures are measured according to the 9-point enveloping surface method over a hemispherical surface, as described in the ISO 13347-3 standard

A weighting uses an octave band correction to allow for the sensitivity of the human ear to certain frequencies.

To obtain the acoustic power level of a fan from the acoustic pressure level at 3 metres, the following formula can be used:

$$L_w = L_p(@ 3m) + 10 \cdot \text{Log}(2 \cdot \pi \cdot R^2) + 20 \cdot \text{Log}(3), \quad \text{where } R = 1$$

To obtain the acoustic power level as a function of the octave range spectrum, the following formula can be used:

$$L_w = 10 \cdot \text{Log} \left(\sum 10^{(0.1 \cdot L_{wi})} \right), \quad \text{where } i = \text{octave band}$$

Caution: some national measurement standards (e.g. BS 848) use measurements taken at distances different from those used in the ISO standards. Depending on the fan size, the sound data obtained is likely to be significantly lower than the one found when measured according to the ISO standards.

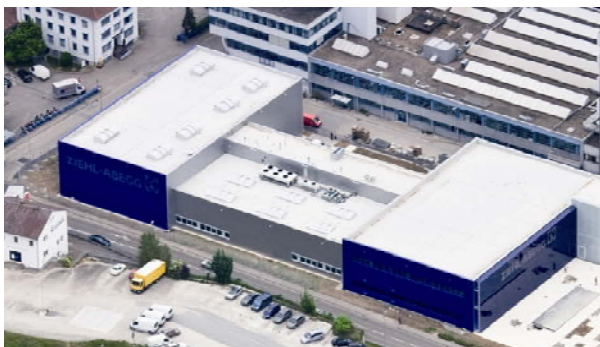

« Invent » Laboratory, Ziehl-Abegg AG, Germany

The MAXvent 2 Range



General tolerances:

- On flow rates : $\pm 5\%$ of nominal flow rate
- On acoustic power and pressure levels : $\pm 3\text{dB}$
- By octave band: $\pm 5\text{dB}$

Air Inlet bellmouth and its effect on aeraulic and acoustic measurements:

Tests were conducted with an optimised bellmouth designed to:

- Minimise integration effects responsible for reduced airflow and for the appearance of a stall point at a lower pressure than specified.
- Optimise the motor consumption
- Minimise integration and stall noise

Moreover, it is important to ensure proper air intake when the fan is installed by allowing a minimum integration distance equivalent to approximately one fan's diameter.

Acoustic system effect and safety guard:

Safety distances to prevent access to hazardous areas are specified in the EN 294 standard .

The use of safety guards is recommended for this purpose. Guards generate resistance to air flow that represents a pressure loss Δp_{sf} for the fan. Pressure loss increases with the square of the fan flow rate.

Fan electrical consumption and sound level are also affected. Guards are proposed as accessories.

Safety information:

The Ziehl-Abegg axial fans are designed to operate inside systems and are merely components of these systems.

The machine manufacturer must satisfy equipment or system safety specifications as per the EN 294 standard .

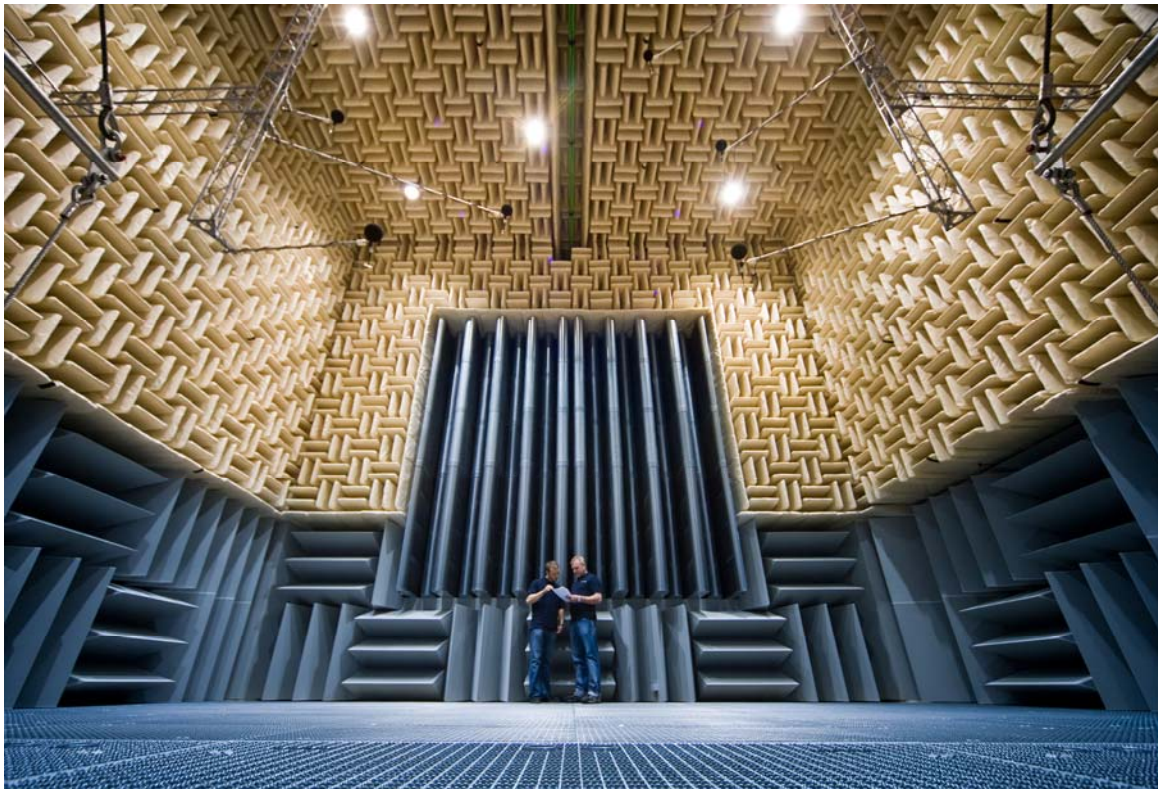

« Invent » Laboratory, Ziehl-Abegg AG, Germany



La gamme MAXvent 2

La gamme MAXvent 2 est née d'une part d'une gamme existante depuis plusieurs années dans le domaine de la ventilation moyenne pression, et d'autre part des efforts des équipes ZIEHL-ABEGG FMV pour répondre à vos besoins spécifiques en terme de performance aérodynamique, de faible niveau sonore, d'avantages techniques et de largeur de gamme.

Deux configurations sont proposées en standard : virole courte et virole longue aux dimensions de la norme EURO-VENT. Grâce à son design éprouvé et aux composants de marque utilisés, nous pouvons garantir la qualité et la fiabilité des ventilateurs de la gamme MAXvent 2.

Nous consacrons aujourd'hui comme hier nos ressources à l'amélioration de nos gammes de ventilateurs dans le but de vous fournir le maximum de performance et de satisfaire l'ensemble de vos exigences techniques.

Description technique

La gamme de ventilateurs hélicoïdes MAXvent 2 est équipée d'une hélice avec des pales en polyamide renforcé fibre de verre (PAG) et un moyeu en alliage d'aluminium (fonderie) conçue pour des applications allant jusqu'à des pressions totales de 1000 Pa selon le diamètre.

En fonction de la perte de charge de votre installation, du diamètre et de la vitesse de l'hélice sélectionnée le débit disponible peut atteindre 130 000 m³/h.

Les débits sont mesurés selon ISO 5801.

Une large gamme:

La gamme MAXvent 2 est disponible en 13 diamètres : 315, 355, 400, 450, 500, 560, 630, 710, 800, 900, 1000, 1250 et 1400 mm.

Les ventilateurs de la gamme MAXvent 2 sont équipés de moteurs asynchrones à rotor intérieur normalisés (IEC). Il s'agit de moteurs à pattes B3, IP55, classe F disponibles en triphasé 230/400V 50Hz jusqu'à 2,2kW et 400/690V 50Hz au-delà avec protection par thermistances PTC.

Selon le diamètre, les moteurs sont disponibles en 2 pôles, 4 pôles, 6 pôles ou 8 pôles.

Pour chaque diamètre et chaque vitesse de rotation la gamme comporte 5 angles d'hélice, au total 185 combinaisons possibles afin de répondre à toutes les demandes:

Ø	2 pôles	4 pôles	6 pôles	8 pôles
315	√	√		
355	√	√		
400	√	√	√	
450	√	√	√	
500	√	√	√	
560	√	√	√	
630	√	√	√	√
710		√	√	√
800		√	√	√
900		√	√	√
1000		√	√	√
1250		√	√	√
1400			√	√

En fonction de votre besoin, nous pouvons vous proposer une solution en virole courte ou longue ou une solution sur plaque carrée aux dimensions adaptées à votre besoin que ce soit en application en gaine ou en application process industriel.

Par ailleurs sont disponibles sur demande toutes les options des moteurs normalisés.

Tous les composants des ventilateurs de la gamme MAXvent 2 sont protégés contre la corrosion et peuvent être peints sur demande.

Configurations standard

La gamme de ventilateurs MAXvent 2 est équipée:

- d'une hélice en matériau composite sélectionnée par nos soins pour votre application et équilibrée selon les prescriptions de la norme ISO 1940 (G = 6.3)
- d'un moteur IEC-IE2 à pattes B3 de marque SIEMENS ou similaire (presse-étoupe non fourni)
- d'une virole en acier.

Conditionnement sur palette.

Deux finitions anticorrosion :

- Casing en acier galvanisé ou zingué
- Casing en acier galvanisé à chaud

Ces ventilateurs peuvent fonctionner indifféremment, axe horizontal ou vertical et sont disponibles pour les deux sens de flux d'air.

Ces ventilateurs sont en accouplement direct: l'hélice directement placée en bout d'arbre du moteur.

Ils peuvent être utilisés en application standard dans toutes applications où l'air véhiculé est propre, non poussiéreux.

La température du flux d'air doit être comprise entre -30°C et +50°C pour les ventilateurs de la section "Standard temperature range" et -30°C et +60°C pour les ventilateurs de la section "Increased Temperature Range".

Accessoires

Variateurs de vitesse, pieds de montage, plots anti-vibratiles, viroles d'entrée d'air, contre-bridés, viroles élastiques, grilles de protection (côté hélice ou côté moteur).

Configurations spéciales

Ziehl-Abegg FMV peut offrir des configurations sur mesure qui répondent au mieux aux besoins de ses clients tel que :

- Construction avec plaque carrée (tous diamètres) adaptée à l'environnement du client
- Construction en acier inoxydable (304 ou 316L) ou finition peinture poudre polyester
- Hélice avec pale aluminium ou polypropylène chargé fibre de verre (PPG)
- Moteur
 - 2 vitesses (bobinages séparés ou Dahlander)
 - 60Hz
 - Thermistances PTO
 - Utilisation basse ou haute température
 - Boîte à bornes déportée sur la virole
 - Toutes les options des moteurs IEC
 - Et beaucoup d'autres possibilités

Nous étudions toute demande différente de nos produits standard.

... Consultez nous!

La gamme MAXvent 2



Légende

- 1 Ventilateur
- 2 Débit d'air
- 3 Pression statique
- 4 Angle d'hélice
- 5 Fréquence
- 6 Taille moteur
- 7 Tension
- 8 Intensité
- 9 Puissance nominale
- 10 Vitesse de rotation
- 11 Niveau de pression sonore @ 3m
- 12 Construction du ventilateur
- 13 Spectre relatif de puissance acoustique
- 14 Accessoires
- 15 Plage de température

FV31V-2D

50Hz	Motor	U	I	P ₂	n
		V	A	kW	min ⁻¹
25°	71 M	400	1	0,37	2740
30°	71 M	400	1	0,37	2740
35°	71 M	400	1,36	0,55	2800
40°	71 M	400	1,36	0,55	2800
45°	80 M	400	1,73	0,75	2855

Pitch Angle	Relative spectrum							
	63	125	250	500	1000	2000	4000	8000
25°	-42	-33	-15	-7	-4	-6	-11	-20
30°	-41	-32	-15	-7	-4	-6	-10	-19
35°	-40	-31	-15	-7	-4	-5	-9	-18
40°	-40	-31	-15	-7	-4	-5	-9	-17
45°	-39	-30	-16	-8	-4	-5	-8	-17

Accessories : see pages 100-102

Standard Temperature Range : -30°C / +50°C

Désignation

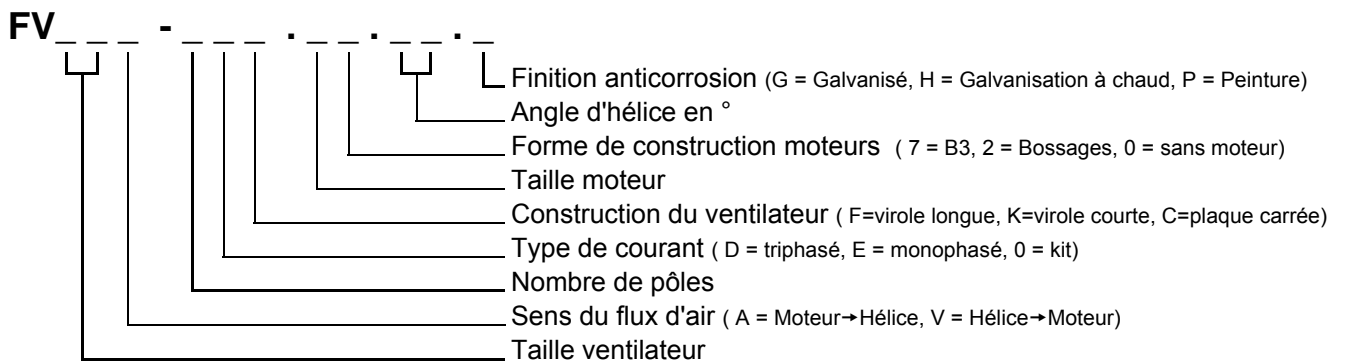

La gamme MAXvent 2



Mesures aérauliques:

Les courbes caractéristiques du ventilateur montrent l'augmentation de pression ΔP_{sf} en Pa en fonction du débit en m^3/h .

Les tests ont été réalisés suivant ISO5801 pour l'aéraulique et au sein de nos laboratoires (laboratoire "Invent" en Allemagne et laboratoire ZA-FMV en France).

Tout un ensemble de mesures effectuées dans nos laboratoires nous ont permis d'établir les courbes présentées ci-après.

Les mesures ont été réalisées en type A, avec virole longue, avec virole d'entrée d'air et sans grilles de protection.

Certains tests ont été corroborés par le CETIAT (laboratoire français agréé).

Le ventilateur est installé dans un caisson de mesures à entrée et sortie libres.

Mesures acoustiques:

Les tests ont été réalisés suivant ISO13347 pour l'acoustique. Les puissances acoustiques pondérées A en L_w sont calculées à partir de niveaux de pression acoustique en bandes d'octave mesurées à l'aspiration du ventilateur.

Les pressions de niveau sonore sont mesurées selon la méthode de la surface enveloppante en 9 points sur une surface hémisphérique décrite dans la norme ISO 13347-3

La pondération A tient compte de la sensibilité de l'oreille humaine à certaines fréquences par une correction en bande d'octave.

Détermination du niveau de puissance acoustique d'un ventilateur à partir du niveau de pression acoustique à 3 mètres:

Détermination du niveau de puissance acoustique en fonction

$$L_w = L_p(@ 3m) + 10 \cdot \text{Log}(2 \cdot \pi \cdot R^2) + 20 \cdot \text{Log}(3), \quad \text{avec } R = 1$$

du spectre en gamme d'octaves:

$$L_w = 10 \cdot \text{Log} \left(\sum 10^{(0.1 \cdot L_{wi})} \right), \quad \text{avec } i = \text{bandes d'octaves}$$

Attention certains anciens standards nationaux de mesures (ex BS 848) font appel à des mesures effectuées à des distances différentes des normes en vigueur. Ces anciens standards peuvent conduire à des valeurs acoustiques minorées de façon significative selon la taille du ventilateur.



Laboratoire "Invent", Ziehl-Abegg AG, Allemagne

La gamme MAXvent 2



Tolérances générales:

- Sur les débits : $\pm 5\%$ du débit nominal
- Sur les niveaux de pression et de puissance acoustique : $\pm 3\text{dB}$
- Par bande d'octave : $\pm 5\text{dB}$

Viroles d'entrée d'air et ses effets sur l'aérodynamique et l'acoustique :

Les essais ont été effectués avec un pavillon d'entrée d'air optimisé permettant :

- De minimiser les effets d'intégration responsables de la diminution du débit et de l'apparition d'un point de pompage à une pression plus basse que prévue.
- D'optimiser la consommation du moto-ventilateur
- De minimiser le bruit d'intégration et de pompage

Par ailleurs il est important d'assurer une bonne entrée d'air quand le ventilateur est installé en respectant une distance minimum d'environ 1 fois le diamètre du ventilateur.

Effet système acoustique et grille de protection :

Les distances de sécurité pour prévenir l'accessibilité avec les zones dangereuses sont spécifiées dans la norme EN 294. Dans ce but nous préconisons l'utilisation de grilles protectrices.

Les grilles occasionnent une résistance au passage du flux d'air qui représente une perte de pression ΔP_{sf} pour le ventilateur, cette perte de pression augmente avec le carré du débit du ventilateur.

La consommation électrique et le niveau sonore du ventilateur sont également affectés.

Les grilles de protection sont proposées en tant qu'accessoires.

Information sur la sécurité :

Les ventilateurs axiaux Ziehl-Abegg sont conçus pour fonctionner à l'intérieur de systèmes et ne sont que des composants de ces systèmes

Le fabricant de la machine doit répondre aux spécifications de sécurité des équipements ou du système selon la norme EN 294.

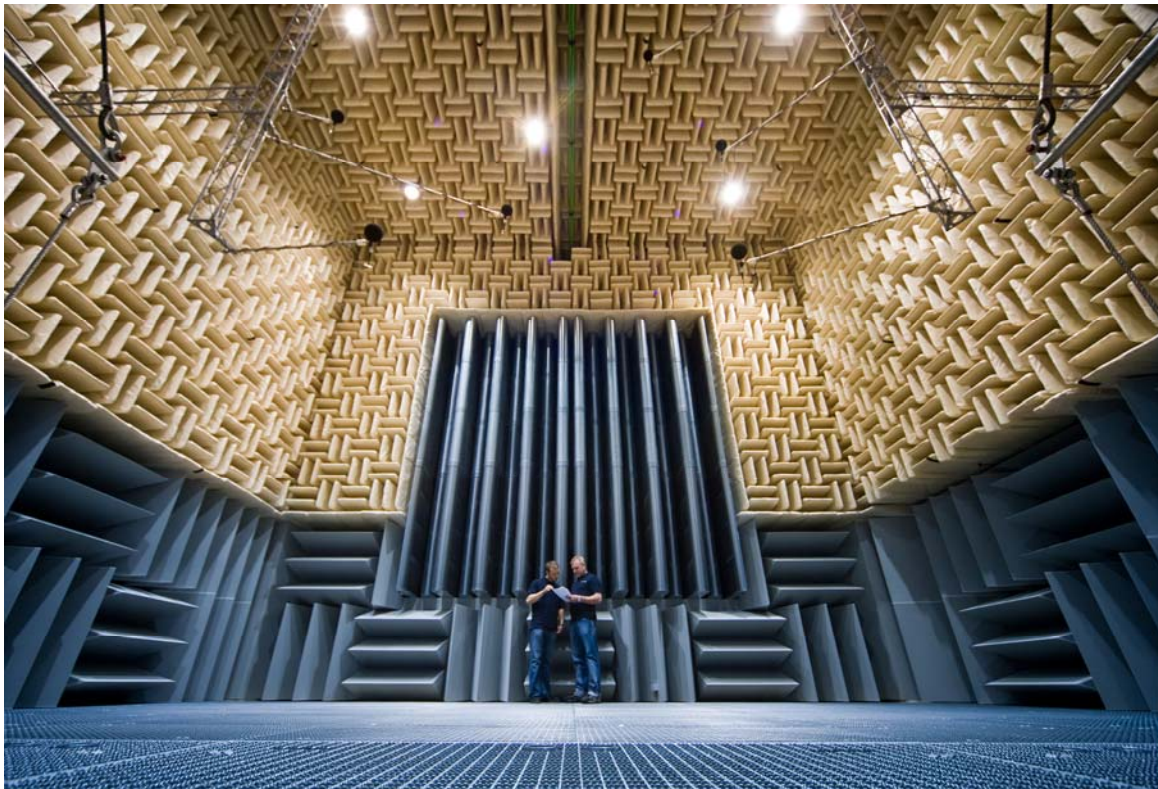

Laboratoire "Invent", Ziehl-Abegg AG, Allemagne



Die Produktreihe MAXvent 2 baut zum einen auf eine seit mehreren Jahren bestehenden Produktreihe im Bereich der Mitteldruckventilatoren auf. Zum anderen ist sie Ausdruck unseres Engagements, auf den spezifischen Bedarf unserer Kunden in den Bereichen Luftleistung, geringen Schallpegels, technischer Optimierungen und Umfang der Produktreihe einzugehen.

Standardmäßig werden zwei Ausführungen angeboten: kurzes und langes Rohrgehäuse entsprechend den Maßen der EUROVENT-Norm. Durch sein anerkanntes Design und seine hochwertigen Komponenten können wir für die Qualität und Zuverlässigkeit der Ventilatoren unserer Produktreihe MAXvent 2 garantieren.

Wir investieren kontinuierlich in die Verbesserung unserer Ventilatoren mit dem Ziel, Ihnen maximale Leistung zur Verfügung zu stellen und Ihren gesamten technischen Anforderungen zu entsprechen.

Technische Beschreibung

Die Produktreihe der MAXvent 2 Ventilatoren ist mit einem Laufrad aus durch Glasfaser verstärktem Polyamid (PAG) und einer Nabe aus einer Aluminium-Druckguss ausgestattet. Dieses wurde speziell für Applikationen entwickelt, bei denen je nach Durchmesser ein Gesamtdruck von bis zu 1000 Pa auftritt.

Je nach Druckabfall Ihrer Installation, Durchmesser und Geschwindigkeit des gewählten Laufrads kann die verfügbare Luftleistung bis zu 130 000 m³/h erreichen. Die Leistung wird gemäß ISO 5801 bemessen.

Eine umfangreiche Produktreihe:

Die Produktreihe MAXvent 2 besteht aus 13 Durchmessern: 315, 355, 400, 450, 500, 560, 630, 710, 800, 900, 1000, 1250 und 1400 mm.

Die Ventilatoren der Produktreihe MAXvent 2 sind mit genormten asynchronen Innenläufermotoren (IEC) ausgestattet. Es handelt sich um B3 Fußmotoren, IP55, Klasse 5, die bis zu 2,2kW dreiphasig mit 230/400 V 50 Hz und darüber mit 400/690 V 50 Hz mit PTC Thermistoren (Kaltleiter) verfügbar sind.

Je nach Durchmesser sind die Motoren 2-, 4-, 6- oder 8-polig erhältlich.

Für jeden Durchmesser und jede verfügbare Drehzahl umfasst die Produktreihe 5 Anstellwinkel, insgesamt also an die 185 mögliche Kombinationen, um auf jeden Bedarf eingehen zu können:

Ø	2 polig	4 polig	6 polig	8 polig
315	√	√		
355	√	√		
400	√	√	√	
450	√	√	√	
500	√	√	√	
560	√	√	√	
630	√	√	√	√
710		√	√	√
800		√	√	√
900		√	√	√
1000		√	√	√
1250		√	√	√
1400			√	√

Je nach Bedarf können wir Ihnen eine Lösung mit kurzem oder langem Rohrkanal oder auch eine Lösung auf quadratischer Platte entsprechend den von Ihnen gewünschten Dimensionen anbieten, egal ob es sich um eine Anwendung in einem Rohrsystem oder um eine industrielle Prozessapplikation handelt.

Auf Anfrage sind alle typischen Optionen für genormte Motoren erhältlich.

Alle Komponenten der Ventilatoren der MAXvent 2 Produktreihe sind korrosionsgeschützt und können auf Anfrage beschichtet werden.

Standardausführungen

Die MAXvent 2 Ventilatorproduktreihe ist ausgestattet mit:

- einem Laufrad aus Verbundstoff, das wir entsprechend Ihrer Anwendung sorgfältig auswählen und gemäß den Vorschriften der Norm ISO 1940 (G = 6,3) wuchten
- einem B3 Fußmotor IEC-IE2 der Marke SIEMENS oder gleichwertig (Kabelverschraubungen sind nicht enthalten)
- einem Rohrkanal aus Stahl

Lieferung auf Palette.

Die Gehäuse werden entweder aus verzinktem Stahl oder aus feuerverzinktem Stahl gefertigt.

Die Ventilatoren können sowohl mit waagrechter als auch mit senkrechter Achse betrieben werden. Beide Luftförderrichtungen sind erhältlich. Das Rad befindet sich auf der Antriebswelle des Motors und wird somit direkt angetrieben.

MAXvent 2 Ventilatoren können für alle Standardapplikationen angewendet werden, bei denen die bewegte Luft sauber und staubfrei ist.

Die Fördermitteltemperatur liegt bei den Ventilatoren der Gruppe "Standard temperature range" zwischen -30° C und +50°C, bei den Ventilatoren der Gruppe "Increased Temperature Range" sind Temperaturen zwischen -30°C und +60°C zulässig.

Zubehör

Drehzahlregler, Montagefüße, Schwingungsdämpfer, Einstromdüsen, Gegenflansche, elastische Stutzen, Schutzgitter (Laufradseite oder Motorseite).

Sonderausführungen

Ziehl-Abegg FMV kann spezifische Ausführungen anbieten, die genau auf die Anforderungen der Kunden abgestimmt sind:

- Fertigung mit quadratischer Platte (alle Durchmesser) in kundenspezifischen Design
- Fertigung aus rostfreiem Edelstahl (304 oder 316L) oder Lackierung mit Polyester
- Laufrad mit Aluminiumschaufeln oder aus mit Glasfaser verstärktem Polypropylen (PPG)
- Motor
 - 2 Drehzahlen (separate Wicklungen oder Dahlander)
 - 60 Hz
 - PTO-Thermokontakte
 - Anwendung bei niedriger oder hoher Temperatur
 - Klemmkasten außen am Rohrkanal
 - Alle Optionen der IEC-Motoren
 -

Wir sind gerne bereit, Ihre spezifischen Anforderungen zu untersuchen. Stellen Sie uns auf die Probe!

Produktreihe MAXvent 2



Legende

- 1 Typ
- 2 Volumenstrom
- 3 Statische Druckerhöhung
- 4 Anstellwinkel
- 5 Frequenz
- 6 Motor-Baugröße
- 7 Bemessungsspannung
- 8 Bemessungsstrom
- 9 Bemessungsleistung
- 10 Bemessungsdrehzahl
- 11 Schalldruckpegel @ 3m
- 12 Ventilator-Bauform
- 13 Spektrum relative Schalleistungspegel
- 14 Zubehör
- 15 Bereich der maximal zulässigen Fördermitteltemperatur

1

FV31V-2D

50Hz	Motor	U	I	P ₂	n
		V	A	kW	min ⁻¹
25°	71 M	400	1	0,37	2740
30°	71 M	400	1	0,37	2740
35°	71 M	400	1,36	0,55	2800
40°	71 M	400	1,36	0,55	2800
45°	80 M	400	1,73	0,75	2855

Pitch Angle	Relative spectrum							
	63	125	250	500	1000	2000	4000	8000
25°	-42	-33	-15	-7	-4	-6	-11	-20
30°	-41	-32	-15	-7	-4	-6	-10	-19
35°	-40	-31	-15	-7	-4	-5	-9	-18
40°	-40	-31	-15	-7	-4	-5	-9	-17
45°	-39	-30	-16	-8	-4	-5	-8	-17

Accessories : see pages 100-102

Standard Temperature Range : -30°C / +50°C

Typenschlüssel

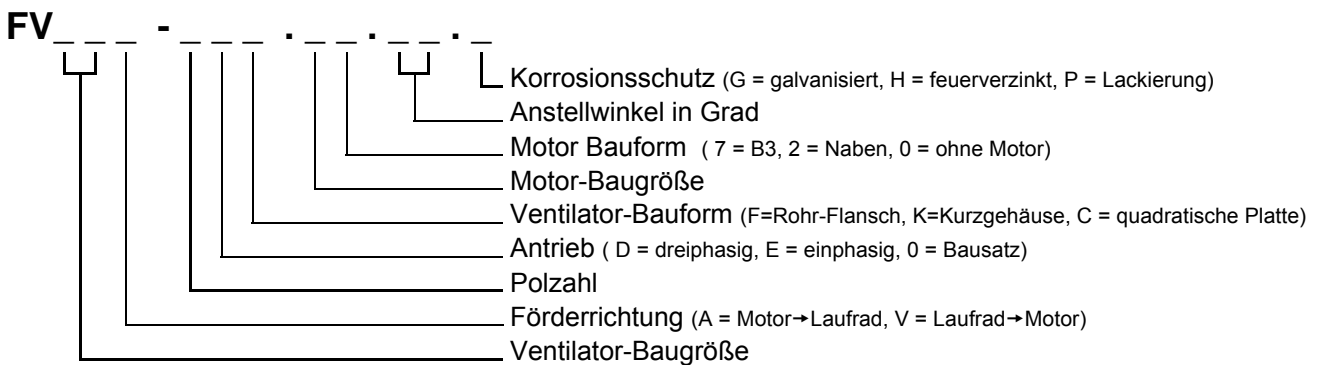

Produktreihe MAXvent 2



Luftmessungen:

Die Ventilator Kennlinien zeigen die statische Druckerhöhung Δp_{st} in Pa als Funktion des Volumenstroms in m^3/h .

Die nachstehend dargestellten Kennlinien konnten auf Grund von zahlreichen Messungen aufgestellt werden.

Die Tests wurden gemäß Norm ISO5801 für Lufttechnik in unseren Labors durchgeführt (Labor "Invent" in Deutschland und Labor ZA-FMV in Frankreich)

Die Messungen erfolgten nach Einbauart Typ A, mit Rohr-Flansch, mit einer optimierten Einströmdüse, ohne Schutzgitter durchgeführt.

Einige Test wurden durch den CETIAT (zertifiziertes französisches Labor) bestätigt.

Der Ventilator ist frei ansaugend, frei ausblasend an die Meßkammer angebaut.

Akustische Messungen:

Die Tests wurden gemäß Norm ISO13347 für Akustik durchgeführt.

Die im Katalog in LP angegebenen A-gewichteten Schalldruckpegel werden berechnet auf der Basis von Schalldruckpegeln, die in Oktavbändern an der Saugseite des Ventilators gemessen werden.

Die Schalldruckpegelmessungen erfolgen nach dem Hüllflächenverfahren an 9 Punkten auf einer halbkugelförmigen Fläche, die in der Norm ISO 13347-3 beschrieben ist.

Die Gewichtung A berücksichtigt durch eine Korrektur im Oktavband die Empfindlichkeit des menschlichen Ohres auf bestimmte Frequenzen.

Ermittlung des Schalleistungspegels eines Ventilators ausgehend vom Schalldruckpegel in einem Abstand von 3 Metern:

$$L_w = L_p (@ 3m) + 10 \cdot \text{Log} (2 \cdot \pi \cdot R^2) + 20 \cdot \text{Log} (3), \quad \text{mit } R = 1$$

Ermittlung des Schalleistungspegels in Abhängigkeit des Spektrums im Oktavband:

$$L_w = 10 \cdot \text{Log} \left(\sum 10^{(0.1 \cdot L_{wi})} \right), \quad \text{mit } i = \text{Oktavband}$$



Anmerkung: Bei einigen nationalen Messnormen (z. B. BS 848) erfolgen die Messungen in Abständen, die sich von den gängigen geltenden Normen unterscheiden können. Dadurch können sich je nach Ventilatorgröße erhebliche Minderungen der ermittelten Schalldruckpegel ergeben.



Labor "Invent", Ziehl-Abegg AG, Deutschland



Allgemeine Toleranzen:

- Förderleistung: $\pm 5\%$ der Nennleistung
- Schalldruck- und Schalleistungspegel: $\pm 3\text{dB}$
- Pro Oktavband: $\pm 5\text{dB}$

Einströmdüse und dessen Auswirkung auf Luftleistung und Akustik:

Die Tests wurden mit einer optimierten Einströmdüse durchgeführt. Dadurch konnten:

- Die Integrationseffekte minimiert werden. Diese führen zu einer Verminderung des Volumenstroms und zum Auftreten einer instabilen Zone (Abrisspunkt) bei bereits niedrigeren Druck.
- Die Leistungsaufnahme des Ventilatormotors vermindert werden.
- Das Geräuschniveau insgesamt minimiert werden.

Außerdem ist die Sicherstellung eines korrekten Lufteintritts wichtig. Dieser ist gegeben, wenn der Ventilator unter Einhaltung eines saugseitigen Mindestabstandes von ca. 1 x dem Durchmesser des Ventilators installiert wird.

Wirkung des akustischen Systems und Schutzgitter:

Die Sicherheitsabstände in Bezug auf den Berührschutz sind in der Norm EN 294 festgelegt.

Wir empfehlen den Einsatz von Schutzgittern.

Die Schutzgitter erzeugen einen Widerstand beim Durchgang des Luftstroms, welcher einen Druckverlust Δp_{sf} für den Ventilator darstellt. Dieser Druckverlust steigt mit dem Quadrat der Ventilatorleistung.

Der Stromverbrauch und der Schallpegel des Ventilators werden ebenfalls beeinflusst.

Die Schutzgitter werden als Zubehör angeboten.

Information über die Sicherheit:

Die Ziehl-Abegg Axialventilatoren sind für den Betrieb innerhalb von Systemen konzipiert und sind lediglich Bestandteile dieser Systeme.

Der Hersteller der Maschine muss die Sicherheitsbestimmungen gemäß Norm EN 294 für die Anlagen bzw. das System beachten.

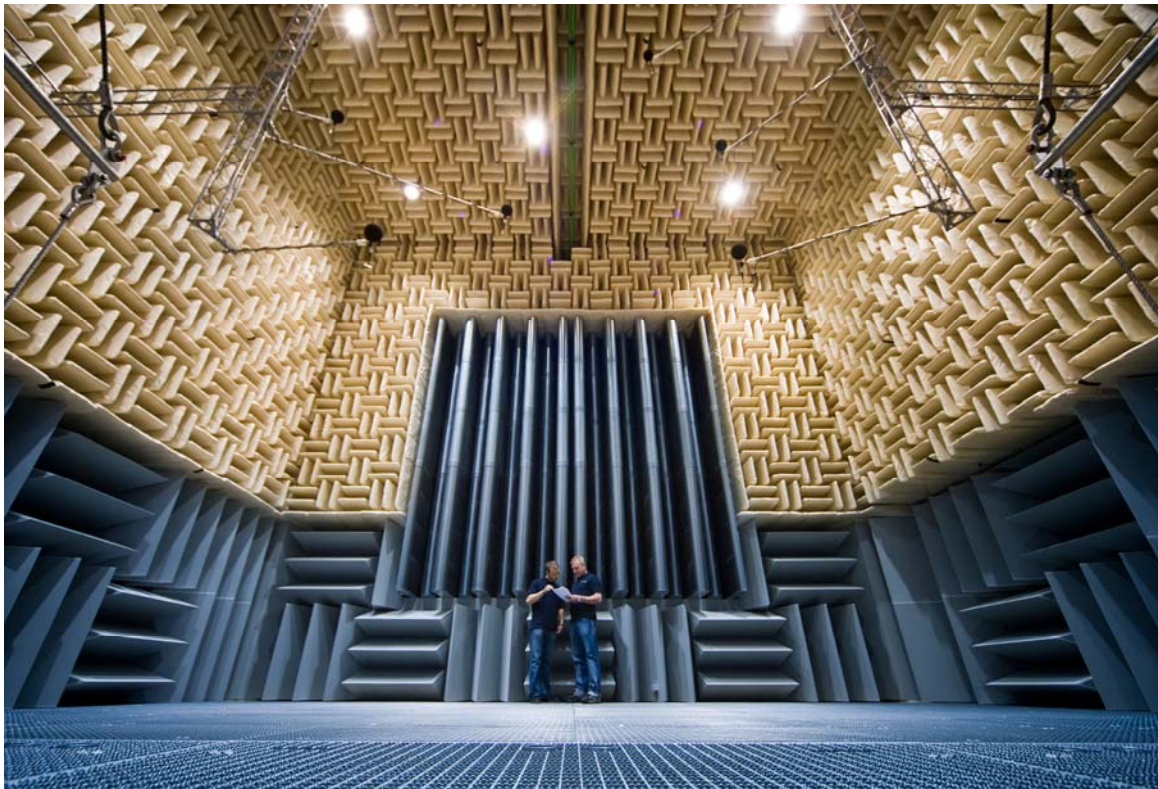

Labor "Invent", Ziehl-Abegg AG, Deutschland



La gama MAXvent 2

La gama MAXvent 2 es el resultado por un lado de una gama existente desde hace varios años en el ámbito de la ventilación de media presión y por otro lado de los esfuerzos de los equipos de ZIEHL-ABEGG FMV para dar respuesta a las necesidades específicas en términos de prestaciones en ventilación, con bajos niveles sonoros y de amplitud de gama.

Se proponen dos configuraciones de serie: carcasa circular corta y larga, según las dimensiones de la norma EUROVENT. Gracias a su comprobado diseño y a los reconocidos componentes utilizados podemos garantizar la calidad y la fiabilidad de los ventiladores de la gama MAXvent 2.

Tanto en la actualidad como en el pasado, dedicamos nuestros recursos a la mejora de nuestra gama de ventilación con la finalidad de proporcionar las máximas prestaciones y de satisfacer el conjunto de sus exigencias técnicas.

Descripción técnica

La gama de ventiladores helicoidales MAXvent 2 está dotada con una hélice con álabes de poliamida reforzada con fibras de vidrio PAG) y una carcasa de aleación de aluminio (fundido) diseñado para aplicaciones que pueden ir hasta presiones totales de 1.000 Pa según el diámetro.

En función de la pérdida de carga de su instalación, del diámetro y de la velocidad de la hélice seleccionada, el caudal disponible puede alcanzar hasta 130.000 m³/h.

Los caudales se miden según la norma ISO 5801.

Una gama amplia:

La gama MAXvent 2 está disponible en 13 diámetros: 315, 355, 400, 450, 500, 560, 630, 710, 800, 900, 1000, 1250 y 1400 mm.

Los ventiladores de la gama MAXvent 2 están dotados con motores asíncronos normalizados de rotor interior (IEC). Se trata de motores B3, IP55, clase F disponibles en 50Hz y corriente trifásica 230/400V 50 Hz hasta 2.2kW y 400/690V 50 Hz más allá, con protecciones PTC.

Según el diámetro, los motores están disponibles en 2, 4, 6 u 8 polos.

Para cada diámetro y cada velocidad de rotación, la gama tiene 5 ángulos de hélice, con un total de 185 combinaciones posibles, para responder a todas las demandas:

Ø	2 polos	4 polos	6 polos	8 polos
315	√	√		
355	√	√		
400	√	√	√	
450	√	√	√	
500	√	√	√	
560	√	√	√	
630	√	√	√	√
710		√	√	√
800		√	√	√
900		√	√	√
1000		√	√	√
1250		√	√	√
1400			√	√

En función de su necesidad, podemos proponerle una carcasa cilíndrica corta o larga o una solución sobre placa cuadrada con las dimensiones adaptadas a su necesidad, ya sea en modo funda o en aplicación de proceso industrial.

Además, bajo pedido están disponibles todas las opciones de motores normalizados.

Todos los elementos de los ventiladores de la gama MAXvent 2 están protegidos contra la corrosión y pueden ser pintados en cualquier RAL bajo pedido.

Configuraciones estándar

La gama de ventiladores MAXvent 2 está dotada de:

- Una hélice de material plástico, seleccionada específicamente para su aplicación y equilibrada según las prescripciones de la norma ISO 1940 (G = 6.3).
- Un motor IEC-IE2 B3, de marca SIEMENS o similar (prensaestopas no suministrado).
- Una carcasa circular de acero.

Acondicionamiento en palet.

Dos acabados anti-corrosión:

- Revestimiento de acero galvanizado o cincado
- Revestimiento de acero galvanizado en caliente

Estos ventiladores pueden funcionar indiferentemente con eje horizontal o vertical y están disponibles en ambos sentidos de flujo de aire.

Estos ventiladores tienen un acoplamiento directo: la rueda está directamente situada en la punta del árbol del motor.

Pueden ser utilizados en todas las aplicaciones en que el aire transportado es limpio, sin polvo.

La temperatura del flujo de aire debe estar entre -30°C y +50°C para los ventiladores de la gama "Standard temperature range" y -30°C y +60°C para los ventiladores de la gama "Increased Temperature Range".

Accesorios

Variadores de velocidad, patas de montaje, tacos antivibración, virolas de entrada de aire, contrabridas, virolas elásticas, rejillas de protección (lado hélice o lado motor).

Configuraciones especiales

La compañía Ziehl-Abegg FMV puede suministrar configuraciones a medida que responden a las necesidades de sus clientes, como:

- Fabricación con placa cuadrada (todos los diámetros), adaptada al entorno del cliente.
- Fabricación de acero inoxidable (304 ou 316L) o pasivado con pintura en polvo de poliéster.
- Hélice con pala de aluminio o de polipropileno con aditivos de fibra de vidrio (PPG)
- Motor
 - 2 velocidades (bobinas separadas o Dahlander)
 - 60Hz
 - Terminancias PTO
 - Utilización en baja o alta temperatura
 - Caja de bornes desplazada hacia la carcasa
 - Todas las opciones de los motores IEC
 -

Estudiamos todas las posibilidades de nuestra gama estándar.

La gama MAXvent 2



Pie

- 1 Ventilador
- 2 Caudal
- 3 Presión estática
- 4 Ángulo de inclinación
- 5 Frecuencia
- 6 Tamaño motor
- 7 Voltaje
- 8 Corriente
- 9 Potencia
- 10 Velocidad asignada
- 11 Presión acústica @ 3m
- 12 Fabricación ventilador
- 13 Nivel relativo de presión sonora del espectro
- 14 Accesorios
- 15 Temperatura

1

FV31V-2D

50Hz	Motor	U	I	P ₂	n
	V	A	kW	min ⁻¹	
25°	71 M	400	1	0,37	2740
30°	71 M	400	1	0,37	2740
35°	71 M	400	1,36	0,55	2800
40°	71 M	400	1,36	0,55	2800
45°	80 M	400	1,73	0,75	2855

Pitch Angle	Relative spectrum							
	63	125	250	500	1000	2000	4000	8000
25°	-42	-33	-15	-7	-4	-6	-11	-20
30°	-41	-32	-15	-7	-4	-6	-10	-19
35°	-40	-31	-15	-7	-4	-5	-9	-18
40°	-40	-31	-15	-7	-4	-5	-9	-17
45°	-39	-30	-16	-8	-4	-5	-8	-17

Accessories : see pages 100-102

Standard Temperature Range : -30°C / +50°C

Designación

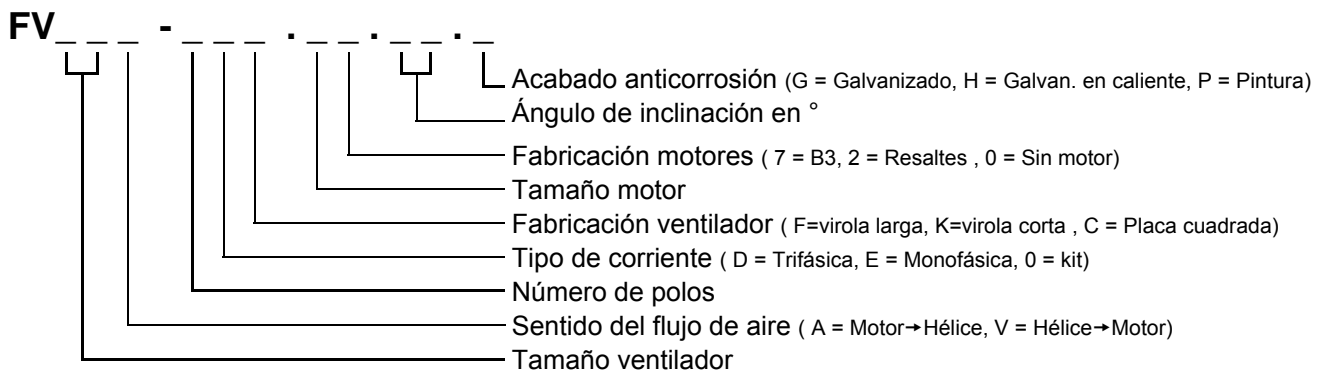

La gama MAXvent 2



Mediciones de caudal:

Las curvas características del ventilador muestran el aumento de pérdida de carga Δp_{sf} en Pa, en función del caudal en m^3/h .

Las pruebas han sido realizadas según ISO 5801 y dentro de nuestros laboratorios (laboratorio "Invent" en Alemania y el laboratorio ZA-FMV en Francia).

Todo un conjunto de mediciones realizadas en nuestros laboratorios nos han permitido elaborar las curvas presentadas abajo.

Las mediciones han sido realizadas en tipo A, con embocadura circular larga, con embocadura alta, sin rejilla de protección.

Algunas pruebas han sido corroboradas por el CETIAT (laboratorio francés homologado).

El ventilador está instalado en un cajón de mediciones con entrada y salida libres.

Mediciones acústicas:

Las pruebas han sido realizadas según ISO 13347 para la acústica.

Las potencias acústicas ponderadas A en L_w se calculan a partir de niveles de presión acústica en bandas de octava medidas en la aspiración del ventilador.

Las presiones de nivel acústico se miden según el método de la superficie envolvente en 9 puntos, sobre una superficie hemisférica descrita en la norma ISO 13347-3.

La ponderación A tiene en cuenta la sensibilidad del oído humano a determinadas frecuencias con una correlación en banda de octava.

Determinación del nivel de potencia acústica de un ventilador a partir del nivel de presión acústica a 3 metros:

$$L_w = L_p (@ 3m) + 10 \cdot \text{Log} (2 \cdot \pi \cdot R^2) + 20 \cdot \text{Log} (3), \quad \text{donde } R = 1$$

Determinación del nivel de potencia acústica en función del espectro en gama de octavas:

$$L_w = 10 \cdot \text{Log} \left(\sum 10^{(0.1 \cdot L_{wi})} \right), \quad \text{donde } i = \text{bandas de octavas}$$

Cuidado: Algunos estándares nacionales de mediciones (Ej. BS 848) utilizan mediciones realizadas a distancias diferentes de las normas vigentes y esto puede suponer disminuciones significativas en función del tamaño del ventilador.



Laboratorio "Invent", Ziehl-Abegg AG, Alemania

La gama MAXvent 2



Tolerancias generales:

- En los caudales: $\pm 5\%$ del caudal nominal
- En los niveles de presión y de potencia sonora: $\pm 3\text{dB}$
- Por banda de octava: $\pm 5\text{dB}$

Embocaduras y sus efectos en la aerólucica y la acústica:

Las pruebas han sido realizadas con una mariposa de entrada optimizada, que permite:

- Minimizar los efectos de integración, responsables de la disminución del caudal y de la aparición de un punto de bombeo a una presión más baja de lo previsto.
- Optimizar el consumo del motoventilador.
- Minimizar el ruido de integración y de bombeo.

Además, es importante asegurar una entrada de aire correcta cuando el ventilador está instalado, dejando una distancia mínima igual a su diámetro.

Efecto en el sistema acústico y rejilla de protección:

Las distancias de seguridad para prevenir el acceso a las zonas peligrosas se especifican en la norma EN 294.

Con esta finalidad, aconsejamos utilizar rejillas de protección. Las rejillas ocasionan una resistencia al paso del flujo de aire que supone aumento en la pérdida de carga Δp_{sf} para el ventilador; esta pérdida de presión aumenta con el cuadrado del caudal del ventilador.

El consumo eléctrico y el nivel acústico del ventilador también se encuentran modificados.

Las rejillas de protección están disponibles como accesorios.

Información sobre la seguridad:

Los ventiladores axiales Ziehl-Abegg están diseñados para funcionar en el interior de sistemas y sólo son componentes de estos sistemas.

El fabricante de la máquina debe cumplir las especificaciones de seguridad de los equipos o del sistema, como lo especifica la norma EN 294.

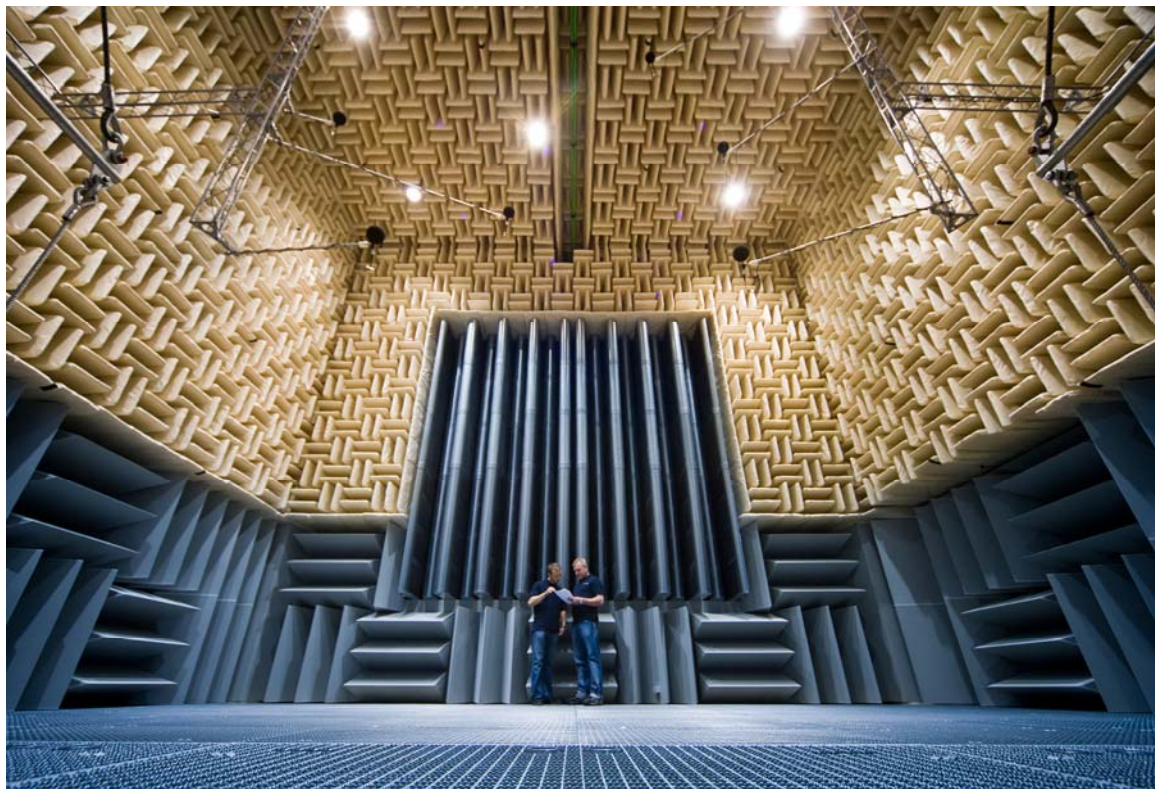

Laboratorio "Invent", Ziehl-Abegg AG, Alemania

La gamma MAXvent 2



La gamma MAXvent 2 ha origine da una parte da una gamma esistente da molti anni nel campo della ventilazione a media pressione e dall'altra parte dagli sforzi dell'equipe ZIEHL-ABEGG FMV per rispondere ai vostri bisogni specifici in termini di prestazioni aerauliche, di basso livello sonoro, di vantaggi tecnici e di ampiezza di gamma.

Sono proposte due configurazioni in standard: cassa d'alloggiamento corta o lunga secondo le dimensioni della norma EUROVENT. Grazie al suo design collaudato ed ai componenti di marca utilizzati, possiamo garantire la qualità e l'affidabilità dei ventilatori della gamma MAXvent 2.

Dedichiamo oggi come ieri tutte le nostre risorse al miglioramento della gamma dei ventilatori allo scopo di fornirvi il massimo delle prestazioni e di soddisfare l'insieme delle vostre esigenze tecniche.

Descrizione tecnica

La gamma di ventilatori elicoidali MAXvent 2 è equipaggiata di una girante con pale in poliammide rinforzato in fibra di vetro (PAG) e un mozzo in lega d'alluminio pressofuso progettato per applicazioni che possono raggiungere delle pressioni totali di 1000 Pa a seconda del diametro.

In funzione della perdita di carico della vostra installazione, del diametro e della velocità della girante scelta la portata disponibile può raggiungere i 130.000 m³/h.

Le portate sono misurate secondo ISO 5801.

Una vasta gamma:

La gamma MAXvent 2 è disponibile in 13 diametri: 315, 355, 400, 450, 500, 560, 630, 710, 800, 900, 1000, 1250 e 1400 mm.

I ventilatori della gamma MAXvent 2 sono equipaggiati con motori asincroni a rotore interno normalizzati (IEC). Si tratta di motori a staffe B3, IP55, classe F disponibili in trifase 230/400V 50Hz fino a 2,2kW e 400/690V 50Hz ed oltre con protezione tramite termistori PTC.

A seconda del diametro, i motori sono disponibili in 2 poli, 4 poli, 6 poli o 8 poli.

Per ogni diametro ed ogni velocità di rotazione la gamma comporta 5 angoli d'inclinazione pala, in totale 185 combinazioni possibili al fine di rispondere a tutte le richieste:

Ø	2 poli	4 poli	6 poli	8 poli
315	√	√		
355	√	√		
400	√	√	√	
450	√	√	√	
500	√	√	√	
560	√	√	√	
630	√	√	√	√
710		√	√	√
800		√	√	√
900		√	√	√
1000		√	√	√
1250		√	√	√
1400			√	√

In funzione delle vostre necessità, possiamo proporvi soluzioni con cassa d'alloggiamento corta o lunga o una soluzione su piastra quadrata, alle dimensioni adatte alle vostre richieste, sia per applicazioni in sistemi canalizzati che per impieghi in processi industriali.

Inoltre sono disponibili su richiesta tutte le opzioni dei motori normalizzati.

Tutti i componenti dei ventilatori della gamma MAXvent 2 sono protetti contro la corrosione e possono essere verniciati su richiesta.

Configurazioni standard

La gamma di ventilatori MAXvent 2 è equipaggiata:

- da una girante in materiale composito selezionata da noi per la vostra applicazione ed equilibrata secondo le prescrizioni della norma ISO 1940 (G = 6.3)
- da un motore IEC-IE2 a staffe B3 di marca SIEMENS o simile (pressacavo non in dotazione)
- da una cassa d'alloggiamento in acciaio.

Imballo su pallet.

Due finiture anticorrosione:

Cassa in acciaio galvanizzato o zincato a freddo

Cassa in acciaio galvanizzato a caldo

Questi ventilatori possono funzionare indifferentemente con l'asse orizzontale o verticale e sono disponibili per entrambi i sensi del flusso d'aria.

Questi ventilatori sono in accoppiamento diretto: la girante è posizionata direttamente all'estremità dell'albero motore.

Nella configurazione Standard, possono essere utilizzati per tutte le applicazioni in cui l'aria veicolata è pulita, non polverosa.

La temperatura del flusso d'aria deve essere compresa tra – 30°C e +50°C per i ventilatori della sezione «Standard temperature range» e -30°C e +60°C per i ventilatori della sezione «Increased Temperature Range».

Accessori

Variatori di velocità, piedi di montaggio, giunti anti-vibranti, boccagli d'aspirazione, contro-flange, giunti elastici, griglie di protezione (lato girante o lato motore).

Configurazioni speciali

Ziehl-Abegg FMV può offrire delle esecuzioni speciali che rispondono al meglio alle necessità del cliente come:

- Costruzione con pannello quadrato (qualsiasi diametro) adatto all'ambiente del cliente
- Costruzione in acciaio inossidabile (304 o 316L) o rifiniture in vernice polvere poliestere
- Girante con pale in alluminio o polipropilene caricato con fibra di vetro (PPG)
- Motore
 - 2 velocità (avvolgimento separato o Dahlander)
 - 60Hz
 - Termistori PTO
 - Uso bassa o alta temperatura
 - Morsettiera sulla cassa d'alloggiamento
 - Tutte le opzioni dei motori IEC
 -

Prenderemo in esame qualsiasi richiesta diversa dai nostri prodotti standard....

Consultateci!

La gamma MAXvent 2



Legende

- 1 Ventilatore
- 2 Portata d'aria
- 3 Pressione statica
- 4 Angolo inclinazione della pala
- 5 Frequenze
- 6 Grandezza motore
- 7 Tensioni
- 8 Corrente
- 9 Potenza nominale
- 10 Velocità nominale
- 11 pressione sonora @ 3m
- 12 Costruzione del ventilatore
- 13 Relativo livello di potenza sonora spettro
- 14 Accessori
- 15 Temperatura

FV31V-2D

50Hz	Motor	U	I	P ₂	n
		V	A	kW	min ⁻¹
25°	71 M	400	1	0,37	2740
30°	71 M	400	1	0,37	2740
35°	71 M	400	1,36	0,55	2800
40°	71 M	400	1,36	0,55	2800
45°	80 M	400	1,73	0,75	2855

Graph 3: P_{st} [Pa] vs q_v [m³/h]. Curves for 25°, 30°, 35°, 40°, 45°.

Graph 11: L_A @ 3m [dB(A)] vs q_v [m³/h]. Curves for 25°, 30°, 35°, 40°, 45°.

Design K and Design F technical drawings.

Pitch Angle	Relative spectrum							
	63	125	250	500	1000	2000	4000	8000
25°	-42	-33	-15	-7	-4	-6	-11	-20
30°	-41	-32	-15	-7	-4	-6	-10	-19
35°	-40	-31	-15	-7	-4	-5	-9	-18
40°	-40	-31	-15	-7	-4	-5	-9	-17
45°	-39	-30	-16	-8	-4	-5	-8	-17

Accessories: see pages 100-102

Standard Temperature Range : -30°C / +50°C

Designazione

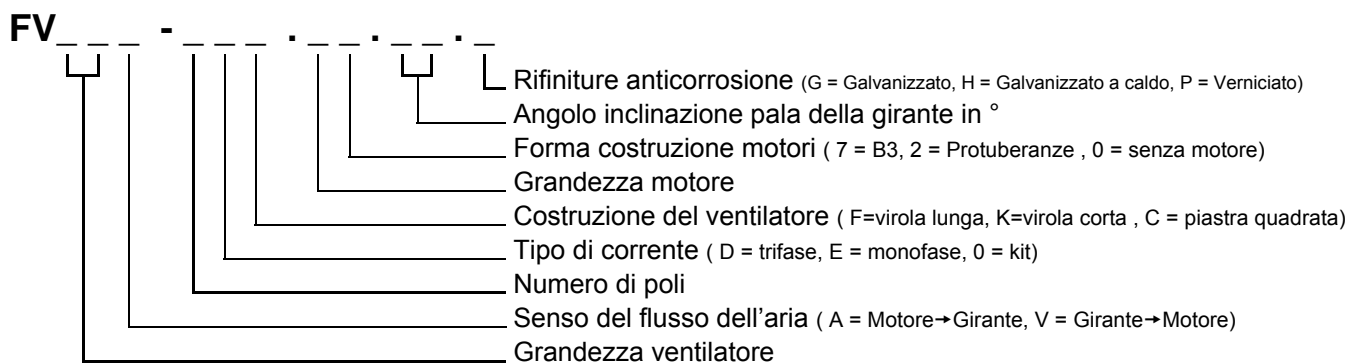

La gamma MAXvent 2



Misure aerauliche:

Le curve caratteristiche del ventilatore indicano l'aumento di pressione Δp_{sf} in pascal in funzione della portata in m³/ora.

I test sono stati effettuati secondo ISO5801 per l'aeraulica e nei nostri laboratori (laboratorio "Invent" in Germania e laboratorio ZA-FMV in Francia).

Tutto un insieme di misure effettuate nei nostri laboratori ci hanno permesso di tracciare le curve presentate qui di seguito.

Le misure sono state effettuate in tipo A, con un casing lungo, con un boccaglio d'ingresso d'aria ottimizzato, senza griglia di protezione.

Alcuni test sono stati convalidati dal CETIAT (laboratorio francese approvato).

Il ventilatore è installato in un cassone per misure con ingresso e uscita liberi.

Misure acustiche:

I test sono stati effettuati secondo ISO13347 per l'acustica.

Le potenze acustiche ponderate A in L_w sono calcolate partendo dai livelli di pressione acustica in bande di ottava misurate durante l'aspirazione del ventilatore.

I livelli di pressione sonora sono misurati secondo il metodo della superficie avvolgente in 9 punti sulla superficie semisferica descritta nella norma ISO 13347-3.

La ponderazione A tiene conto della sensibilità dell'orecchio umano a certe frequenze tramite una correzione in banda d'ottava.

Determinazione del livello di potenza acustica di un ventilatore partendo dal livello di pressione acustica a 3 metri:

Determinazione del livello di potenza acustica in funzione dello

$$L_w = L_p (@ 3m) + 10 \cdot \text{Log} (2 \cdot \pi \cdot R^2) + 20 \cdot \text{Log} (3), \quad \text{con } R = 1$$

spettro in gamme di ottave:

$$L_w = 10 \cdot \text{Log} \left(\sum 10^{(0.1 \cdot L_{wi})} \right), \quad \text{con } i = \text{banda di ottave}$$

Attenzione: alcuni vecchi standard di misure nazionali (es. BS 848) si affidano a misure effettuate a distanze diverse dalle norme vigenti; questo può dar luogo a sottovalutazioni significative a seconda delle dimensioni del ventilatore.

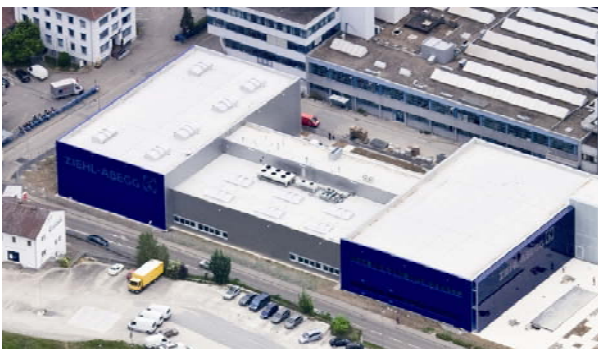

Laboratorio "Invent", Ziehl-Abegg AG, Germania

La gamma MAXvent 2



Tolleranze generali:

- Sulle portate: $\pm 5\%$ della portata nominale
- Sui livelli di pressione e di potenza acustica: $\pm 3\text{dB}$
- Per banda di ottava: $\pm 5\text{dB}$

Bocagli d'ingresso d'aria ed effetti sull'aeraulica e l'acustica:

Le prove sono state effettuate con un bocaglio d'ingresso d'aria ottimizzato, che permette:

- di ridurre gli effetti d'integrazione responsabili della riduzione della portata e dell'apparizione di un punto di pompaggio a una pressione inferiore a quella prevista
- di ottimizzare il consumo del motoventilatore
- di ridurre il rumore d'integrazione e di pompaggio

D'altronde è importante assicurare un buon ingresso d'aria quando il ventilatore è installato, pur rispettando una minima distanza di circa 1 volta il diametro del ventilatore.

Effetto sistema acustico e griglia di protezione:

Le distanze di sicurezza per evitare l'accessibilità alle zone pericolose sono specificate nella norma EN 294.

A tale scopo raccomandiamo l'uso delle griglie di protezione.

Le griglie provocano una resistenza al passaggio del flusso d'aria, che rappresenta una perdita di pressione Δp_{sf} per il ventilatore; tale perdita di pressione aumenta con il quadrato della portata del ventilatore.

Il consumo elettrico e il livello sonoro del ventilatore sono ugualmente interessati.

Le griglie di protezione sono proposte come accessori.

Informazione sulla sicurezza:

I ventilatori assiali Ziehl-Abegg sono predisposti per funzionare all'interno dei sistemi e sono soltanto componenti degli stessi.

Il produttore della macchina deve conformarsi alle specifiche di sicurezza delle attrezzature o del sistema secondo la norma EN 294.

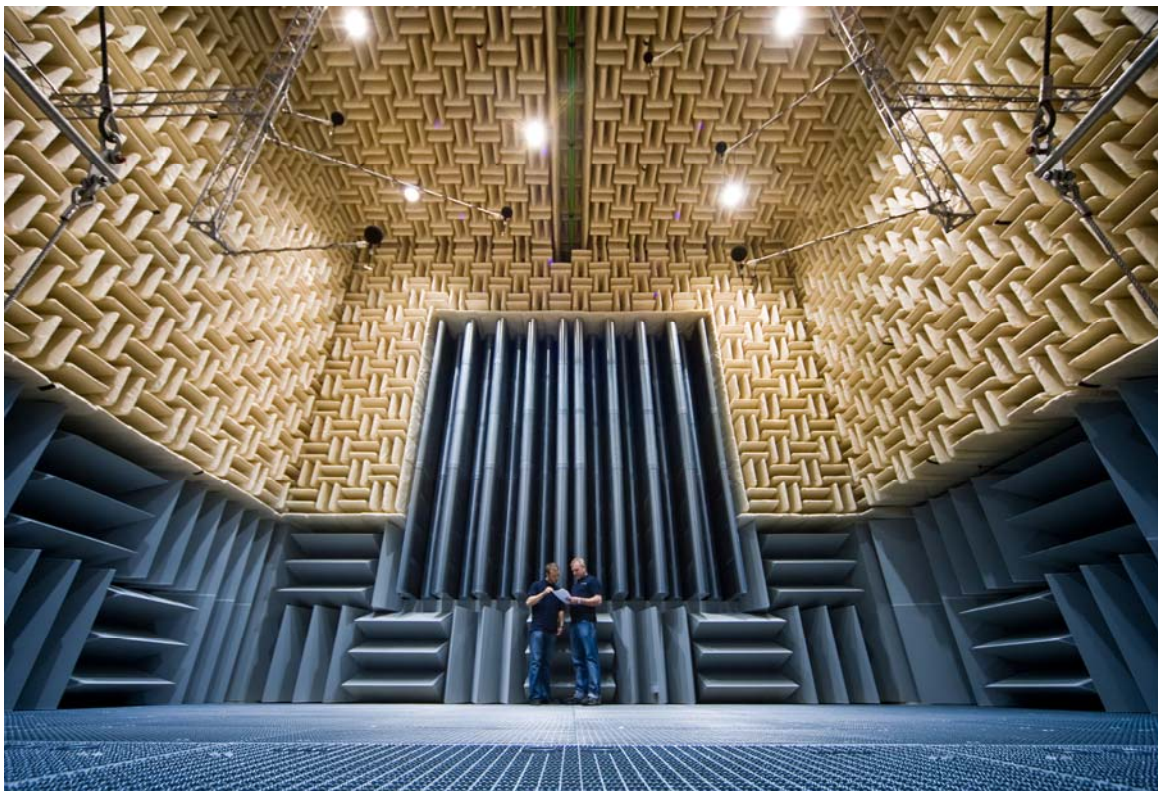

Laboratorio "Invent", Ziehl-Abegg AG, Germania

Standard Temperature Range

Working Temperature : - 30°C / + 50°C

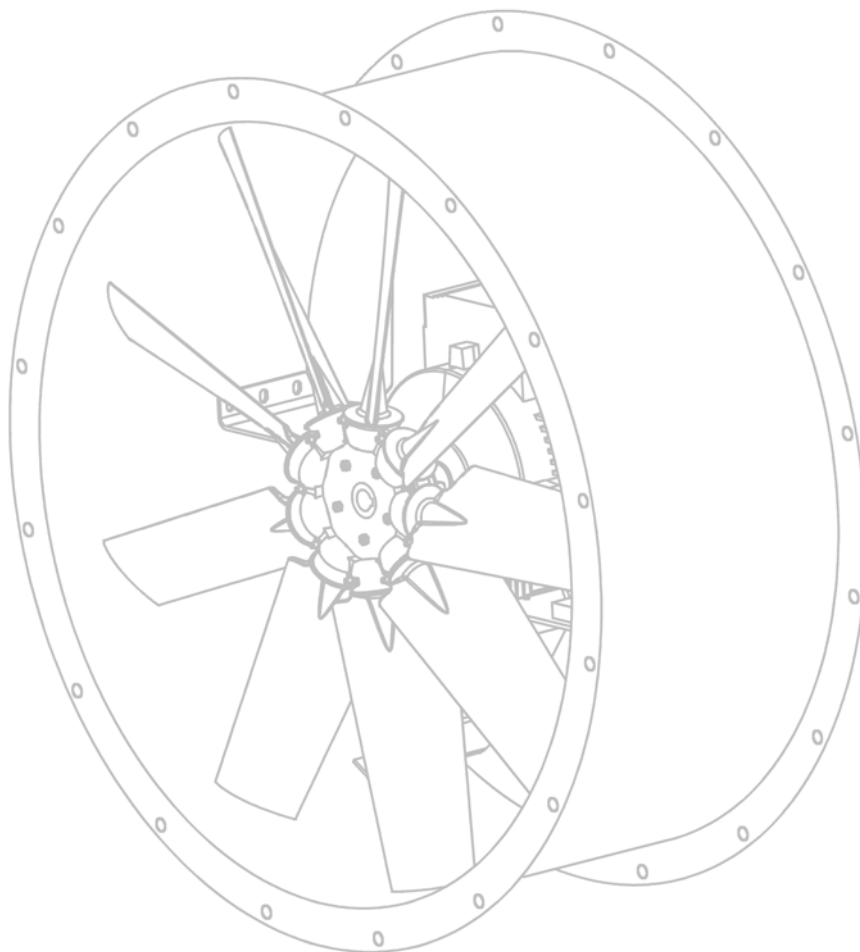

Standard Temperature Range : -30°C / +50°C



FV31V-2D



50Hz Motor	U	I	P ₂	n	
	V	A	kW	min ⁻¹	
25°	71 M	400	1	0,37*	2740
30°	71 M	400	1	0,37*	2740
35°	71 M	400	1,36	0,55*	2800
40°	71 M	400	1,36	0,55*	2800
45°	80 M	400	1,75	0,75	2855

*out of IE2 standard scope

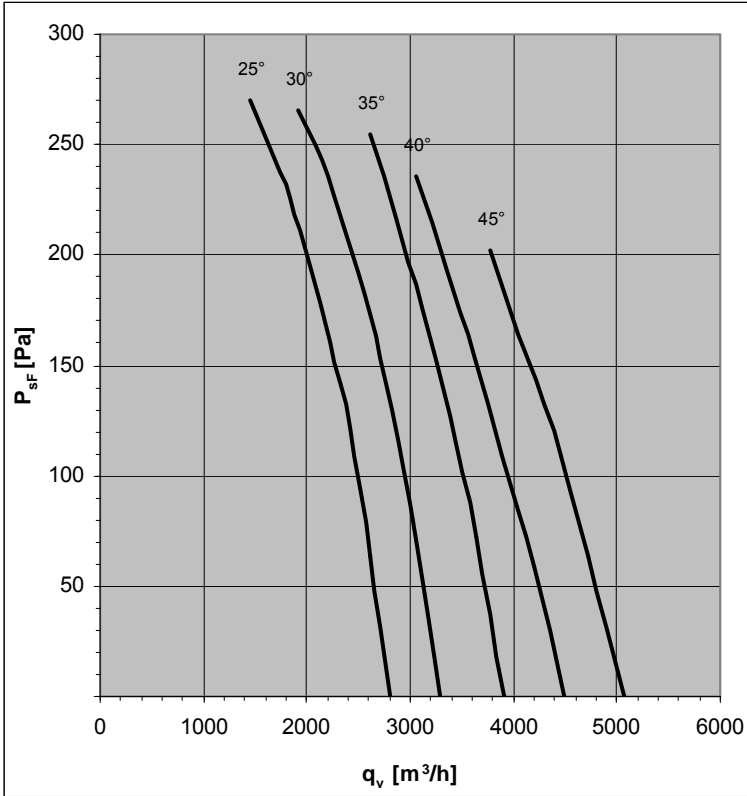

Design K

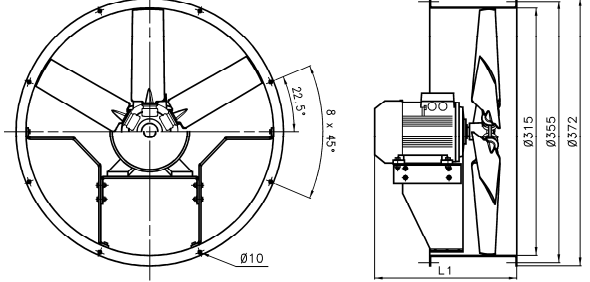

Design F

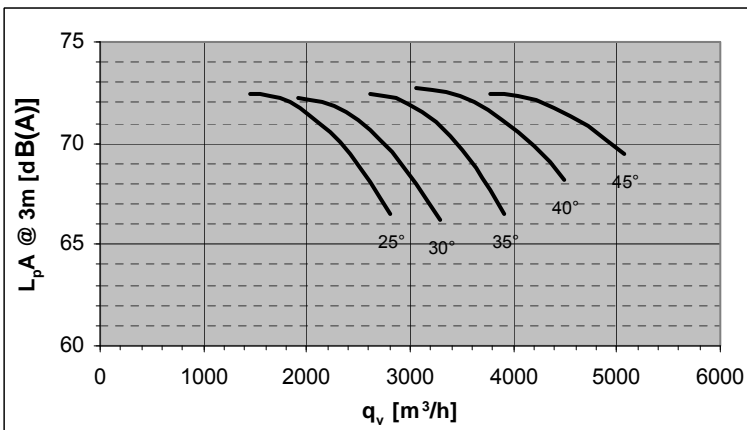
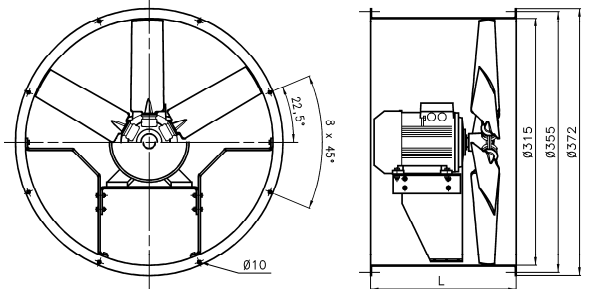

Pitch Angle	Relative spectrum LW dB(A)							
	63	125	250	500	1000	2000	4000	8000
25°	-42	-33	-15	-7	-4	-6	-11	-20
30°	-41	-32	-15	-7	-4	-6	-10	-19
35°	-40	-31	-15	-7	-4	-5	-9	-18
40°	-40	-31	-15	-7	-4	-5	-9	-17
45°	-39	-30	-16	-8	-4	-5	-8	-17

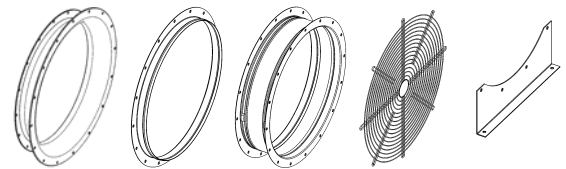

Accessories : see pages 104-106

Design	Pitch Angle	Type (G finish)	Part N°	Type (H finish)	Part N°	L1(mm)	L(mm)	Weight (kg)
K	25°	FV31V-2DK.A7.25.G	150000	FV31V-2DK.A7.25.H	150001	304	260	15
	30°	FV31V-2DK.A7.30.G	150004	FV31V-2DK.A7.30.H	150005	304	260	15
	35°	FV31V-2DK.A7.35.G	150008	FV31V-2DK.A7.35.H	150009	304	260	16
	40°	FV31V-2DK.A7.40.G	150012	FV31V-2DK.A7.40.H	150013	304	260	16
	45°	FV31V-2DK.B7.45.G	150016	FV31V-2DK.B7.45.H	150017	338	260	19
F	25°	FV31V-2DF.A7.25.G	150002	FV31V-2DF.A7.25.H	150003	---	365	17
	30°	FV31V-2DF.A7.30.G	150006	FV31V-2DF.A7.30.H	150007	---	365	17
	35°	FV31V-2DF.A7.35.G	150010	FV31V-2DF.A7.35.H	150011	---	365	18
	40°	FV31V-2DF.A7.40.G	150014	FV31V-2DF.A7.40.H	150015	---	365	18
	45°	FV31V-2DF.B7.45.G	150018	FV31V-2DF.B7.45.H	150019	---	365	21

FV31V-4D



50Hz Motor	U	I	P ₂	n	
	V	A	kW	min ⁻¹	
25°	56 M	400	0,2	0,06*	1350
30°	56 M	400	0,2	0,06*	1350
35°	56 M	400	0,2	0,06*	1350
40°	56 M	400	0,2	0,06*	1350
45°	56 M	400	0,29	0,09*	1350

*out of IE2 standard scope

Standard Temperature Range : -30°C / +50°C

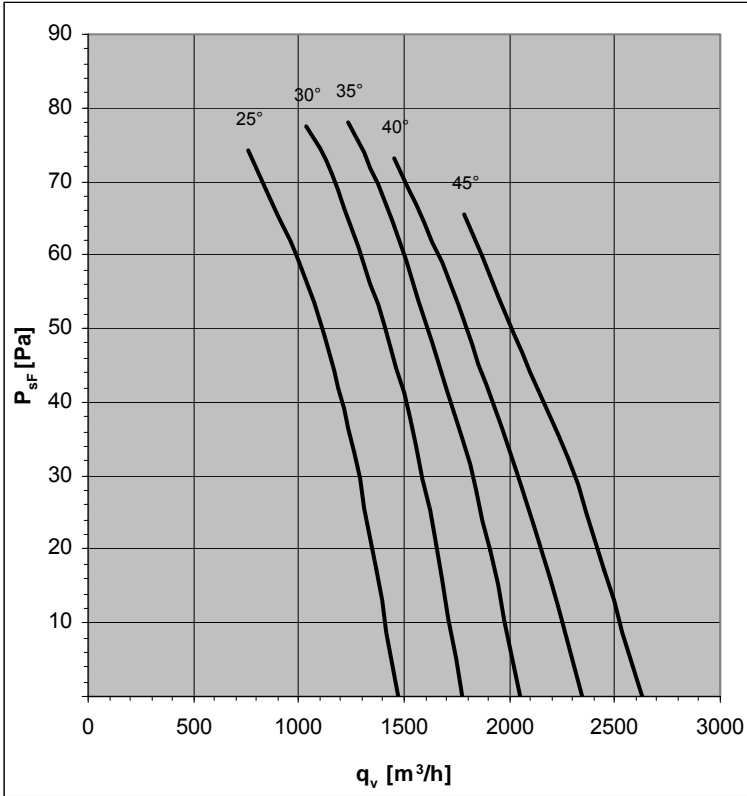

Design K

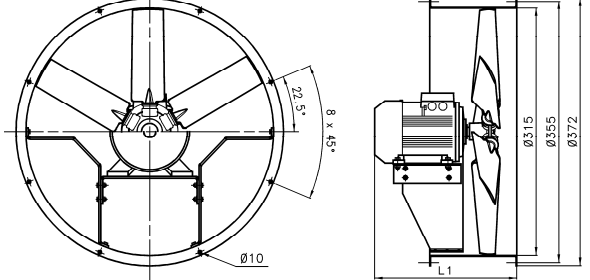

Design F

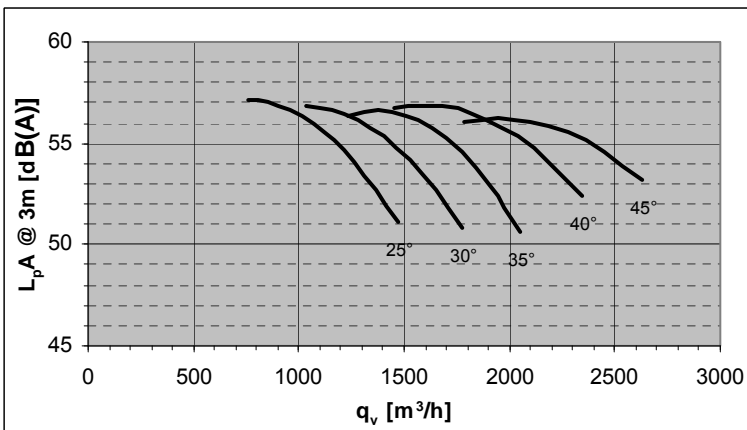
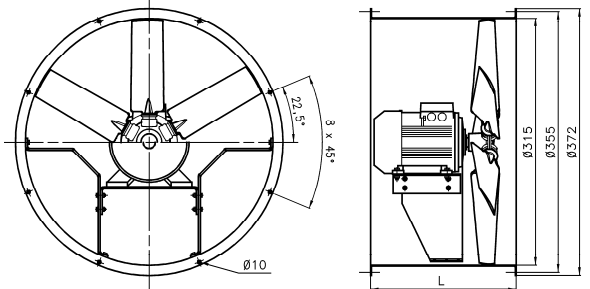

Pitch Angle	Relative spectrum LW dB(A)							
	63	125	250	500	1000	2000	4000	8000
25°	-34	-27	-12	-6	-3	-5	-9	-17
30°	-33	-26	-12	-6	-3	-5	-8	-16
35°	-32	-25	-12	-6	-3	-4	-8	-15
40°	-32	-25	-12	-6	-3	-4	-7	-14
45°	-32	-25	-13	-6	-3	-4	-7	-14

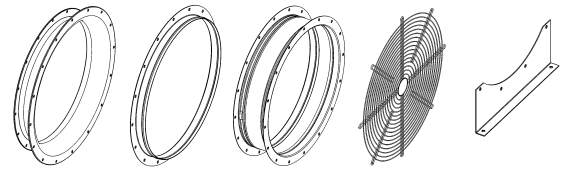

Accessories : see pages 104-106

Design	Pitch Angle	Type (G finish)	Part N°	Type (H finish)	Part N°	L1(mm)	L(mm)	Weight (kg)
K	25°	FV31V-4DK.87.25.G	150020	FV31V-4DK.87.25.H	150021	269	260	12
	30°	FV31V-4DK.87.30.G	150024	FV31V-4DK.87.30.H	150025	269	260	12
	35°	FV31V-4DK.87.35.G	150028	FV31V-4DK.87.35.H	150029	269	260	12
	40°	FV31V-4DK.87.40.G	150032	FV31V-4DK.87.40.H	150033	269	260	12
	45°	FV31V-4DK.87.45.G	150036	FV31V-4DK.87.45.H	150037	269	260	12
F	25°	FV31V-4DF.87.25.G	150022	FV31V-4DF.87.25.H	150023	---	365	14
	30°	FV31V-4DF.87.30.G	150026	FV31V-4DF.87.30.H	150027	---	365	14
	35°	FV31V-4DF.87.35.G	150030	FV31V-4DF.87.35.H	150031	---	365	14
	40°	FV31V-4DF.87.40.G	150034	FV31V-4DF.87.40.H	150035	---	365	14
	45°	FV31V-4DF.87.45.G	150038	FV31V-4DF.87.45.H	150039	---	365	14

FV35V-2D



50Hz Motor	U	I	P ₂	n	
	V	A	kW	min ⁻¹	
25°	71 M	400	1,36	0,55*	2800
30°	80 M	400	1,75	0,75	2855
35°	80 M	400	2,4	1,1	2870
40°	80 M	400	2,4	1,1	2870
45°	90 S	400	3,13	1,5	2890

*out of IE2 standard scope

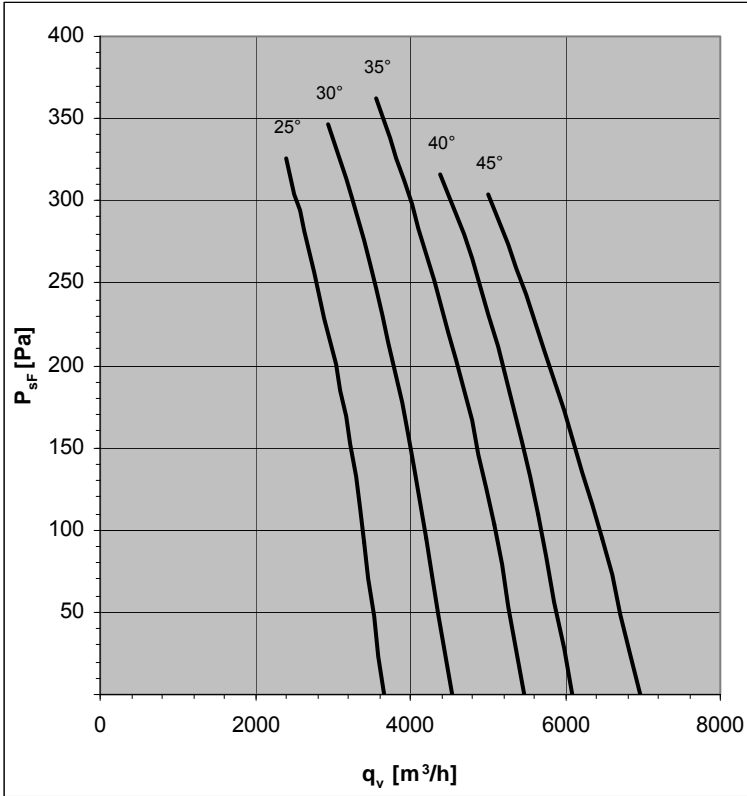

Design K

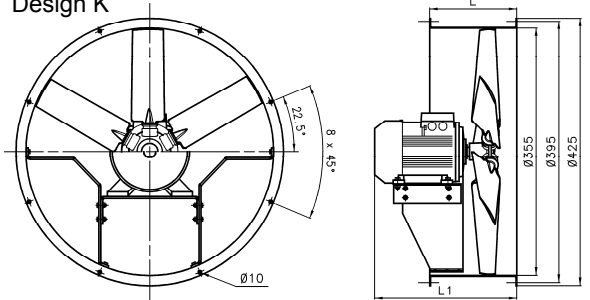

Design F

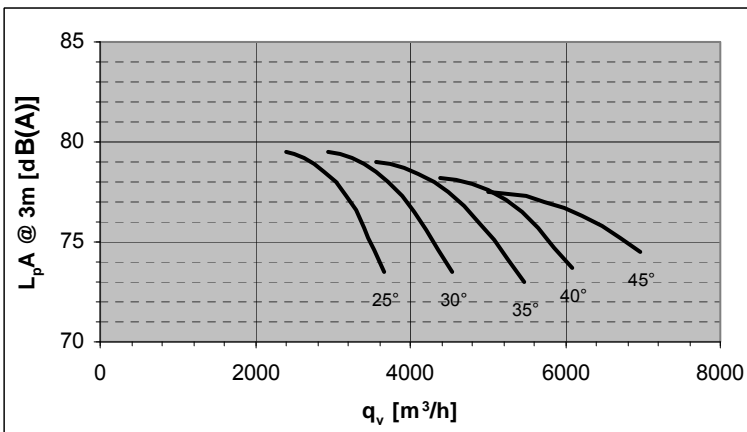
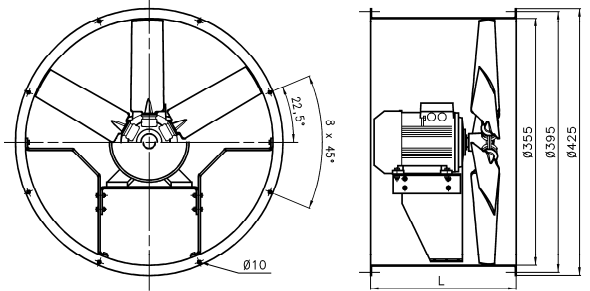

Pitch Angle	Relative spectrum LW dB(A)							
	63	125	250	500	1000	2000	4000	8000
25°	-46	-36	-16	-8	-4	-6	-12	-22
30°	-44	-35	-16	-8	-4	-6	-11	-21
35°	-43	-34	-16	-8	-4	-6	-10	-20
40°	-42	-33	-16	-8	-4	-6	-10	-19
45°	-41	-32	-17	-8	-4	-5	-9	-18

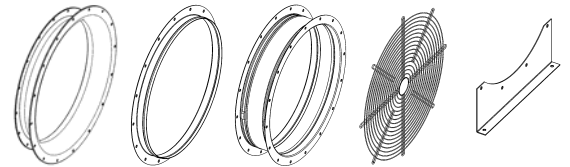

Accessories : see pages 104-106

Design	Pitch Angle	Type (G finish)	Part N°	Type (H finish)	Part N°	L1(mm)	L(mm)	Weight (kg)
K	25°	FV35V-2DK.A7.25.G	150052	FV35V-2DK.A7.25.H	150053	304	260	18
	30°	FV35V-2DK.B7.30.G	150056	FV35V-2DK.B7.30.H	150057	338	260	21
	35°	FV35V-2DK.B7.35.G	150060	FV35V-2DK.B7.35.H	150061	351	260	25
	40°	FV35V-2DK.B7.40.G	150064	FV35V-2DK.B7.40.H	150065	351	260	25
	45°	FV35V-2DK.C7.45.G	150068	FV35V-2DK.C7.45.H	150069	372	260	29
F	25°	FV35V-2DF.A7.25.G	150054	FV35V-2DF.A7.25.H	150055	---	400	21
	30°	FV35V-2DF.B7.30.G	150058	FV35V-2DF.B7.30.H	150059	---	400	24
	35°	FV35V-2DF.B7.35.G	150062	FV35V-2DF.B7.35.H	150063	---	400	28
	40°	FV35V-2DF.B7.40.G	150066	FV35V-2DF.B7.40.H	150067	---	400	28
	45°	FV35V-2DF.C7.45.G	150070	FV35V-2DF.C7.45.H	150071	---	400	32

FV35V-4D



50Hz Motor	U	I	P ₂	n	
	V	A	kW	min ⁻¹	
25°	56 M	400	0,2	0,06*	1350
30°	56 M	400	0,29	0,09*	1350
35°	63 M	400	0,42	0,12*	1350
40°	63 M	400	0,42	0,12*	1350
45°	63 M	400	0,58	0,18*	1350

*out of IE2 standard scope

Standard Temperature Range : -30°C / +50°C

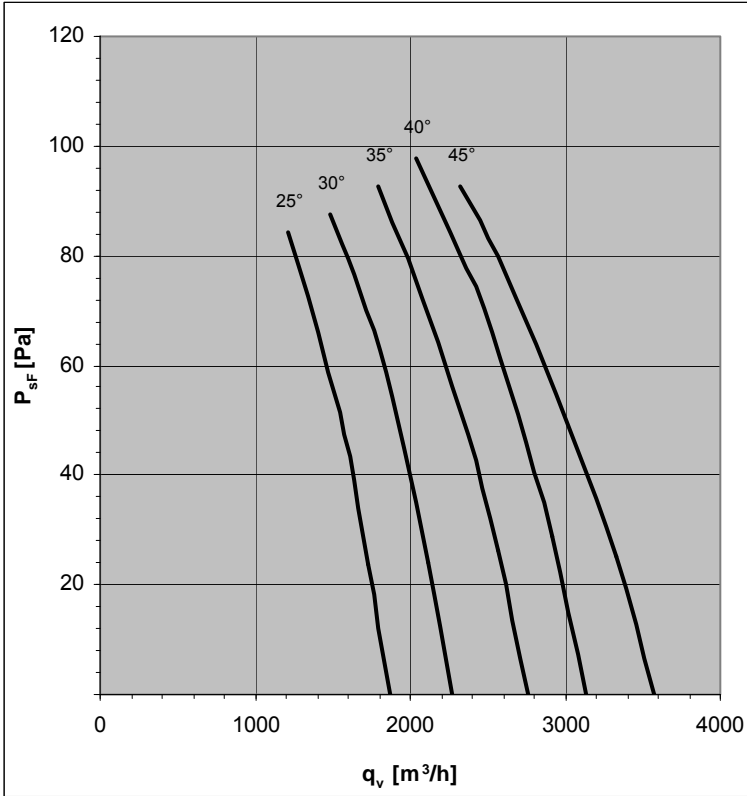

Design K

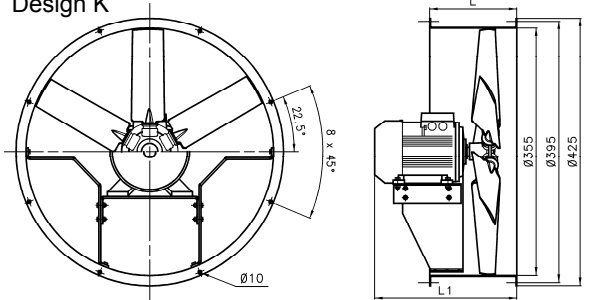

Design F

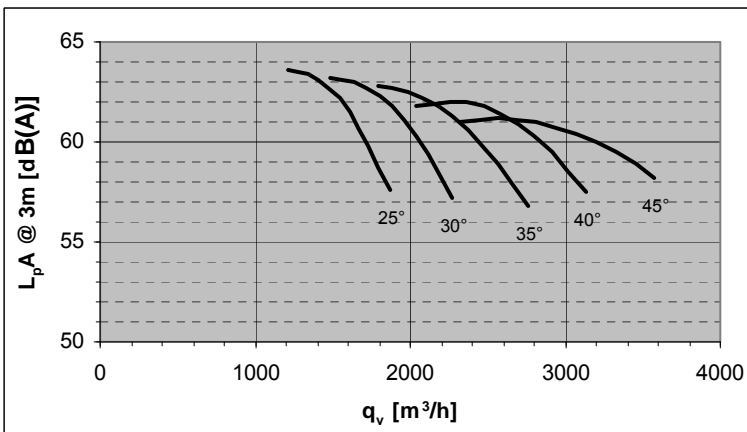
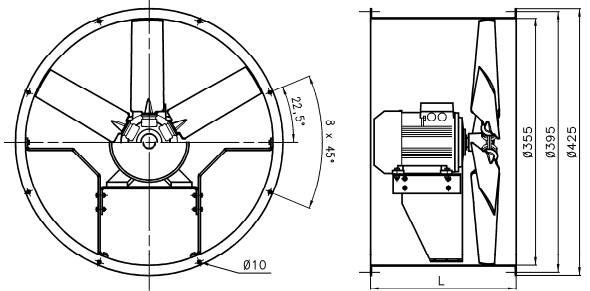

Pitch Angle	Relative spectrum LW dB(A)							
	63	125	250	500	1000	2000	4000	8000
25°	-38	-30	-13	-6	-4	-5	-10	-18
30°	-36	-29	-13	-6	-3	-5	-9	-17
35°	-35	-28	-13	-6	-3	-5	-8	-16
40°	-35	-27	-13	-7	-3	-5	-8	-15
45°	-34	-26	-14	-7	-3	-4	-7	-14

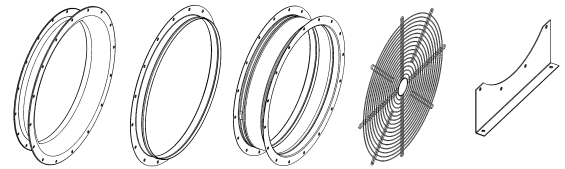

Accessories : see pages 104-106

Design	Pitch Angle	Type (G finish)	Part N°	Type (H finish)	Part N°	L1(mm)	L(mm)	Weight (kg)
K	25°	FV35V-4DK.87.25.G	150072	FV35V-4DK.87.25.H	150073	269	260	14
	30°	FV35V-4DK.87.30.G	150076	FV35V-4DK.87.30.H	150077	269	260	14
	35°	FV35V-4DK.97.35.G	150080	FV35V-4DK.97.35.H	150081	296	260	14
	40°	FV35V-4DK.97.40.G	150084	FV35V-4DK.97.40.H	150085	296	260	14
	45°	FV35V-4DK.97.45.G	150088	FV35V-4DK.97.45.H	150089	296	260	15
F	25°	FV35V-4DF.87.25.G	150074	FV35V-4DF.87.25.H	150075	---	400	17
	30°	FV35V-4DF.87.30.G	150078	FV35V-4DF.87.30.H	150079	---	400	17
	35°	FV35V-4DF.97.35.G	150082	FV35V-4DF.97.35.H	150083	---	400	17
	40°	FV35V-4DF.97.40.G	150086	FV35V-4DF.97.40.H	150087	---	400	17
	45°	FV35V-4DF.97.45.G	150090	FV35V-4DF.97.45.H	150091	---	400	18

FV40V-2D



50Hz Motor	U	I	P ₂	n	
	V	A	kW	min ⁻¹	
25°	80 M	400	2,4	1,1	2870
30°	80 M	400	2,4	1,1	2870
35°	90 S	400	3,13	1,5	2890
40°	90 L	400	4,49	2,2	2890
45°	100 L	400	5,88	3	2890

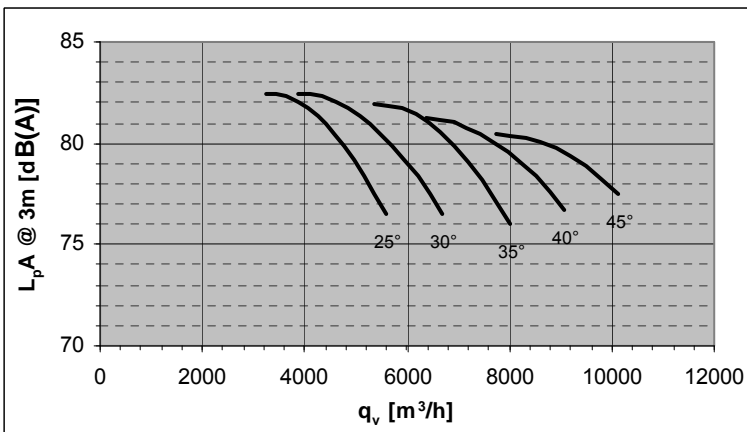
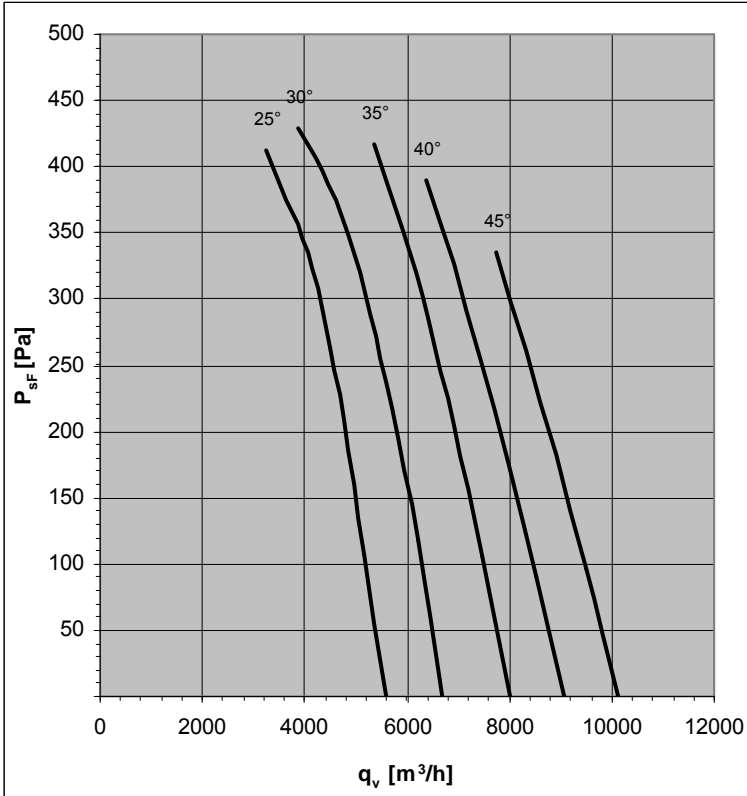

Design K

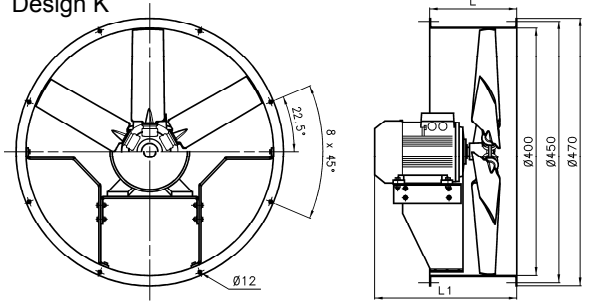

Design F

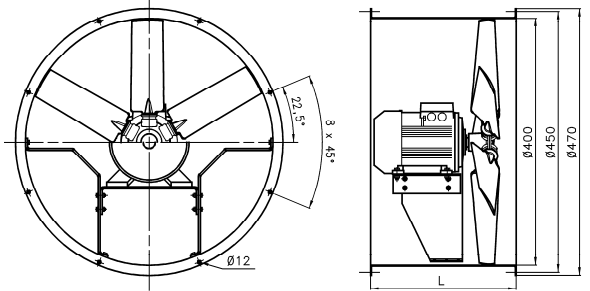

Pitch Angle	Relative spectrum LW dB(A)							
	63	125	250	500	1000	2000	4000	8000
25°	-47	-37	-16	-8	-4	-6	-12	-23
30°	-46	-36	-16	-8	-4	-6	-11	-22
35°	-44	-35	-17	-8	-4	-6	-10	-20
40°	-44	-34	-17	-8	-4	-6	-10	-19
45°	-43	-33	-17	-8	-4	-6	-9	-18

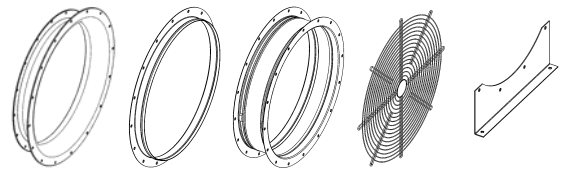

Accessories : see pages 104-106

Design	Pitch Angle	Type (G finish)	Part N°	Type (H finish)	Part N°	L1(mm)	L(mm)	Weight (kg)
K	25°	FV40V-2DK.B7.25.G	150112	FV40V-2DK.B7.25.H	150113	351	260	27
	30°	FV40V-2DK.B7.30.G	150116	FV40V-2DK.B7.30.H	150117	351	260	27
	35°	FV40V-2DK.C7.35.G	150120	FV40V-2DK.C7.35.H	150121	372	260	31
	40°	FV40V-2DK.D7.40.G	150124	FV40V-2DK.D7.40.H	150125	397	260	35
	45°	FV40V-2DK.E7.45.G	150128	FV40V-2DK.E7.45.H	150129	444	260	42
F	25°	FV40V-2DF.B7.25.G	150114	FV40V-2DF.B7.25.H	150115	---	470	31
	30°	FV40V-2DF.B7.30.G	150118	FV40V-2DF.B7.30.H	150119	---	470	31
	35°	FV40V-2DF.C7.35.G	150122	FV40V-2DF.C7.35.H	150123	---	470	35
	40°	FV40V-2DF.D7.40.G	150126	FV40V-2DF.D7.40.H	150127	---	470	40
	45°	FV40V-2DF.E7.45.G	150130	FV40V-2DF.E7.45.H	150131	---	470	47

FV40V-4D



50Hz Motor	U	I	P ₂	n
	V	A	kW	min ⁻¹
25°	56 M	400	0,29	1350
30°	63 M	400	0,42	1350
35°	63 M	400	0,58	1350
40°	71 M	400	0,77	1350
45°	71 M	400	0,77	1350

*out of IE2 standard scope

Standard Temperature Range : -30°C / +50°C

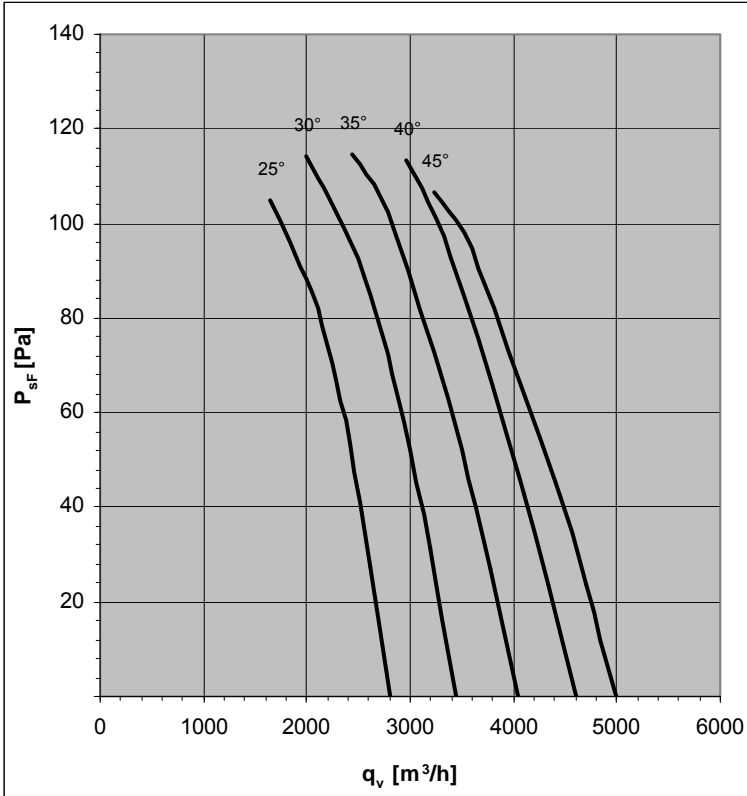

Design K

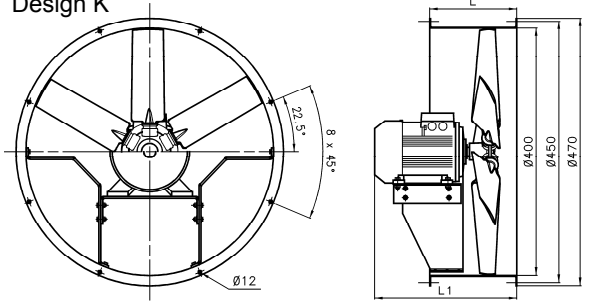

Design F

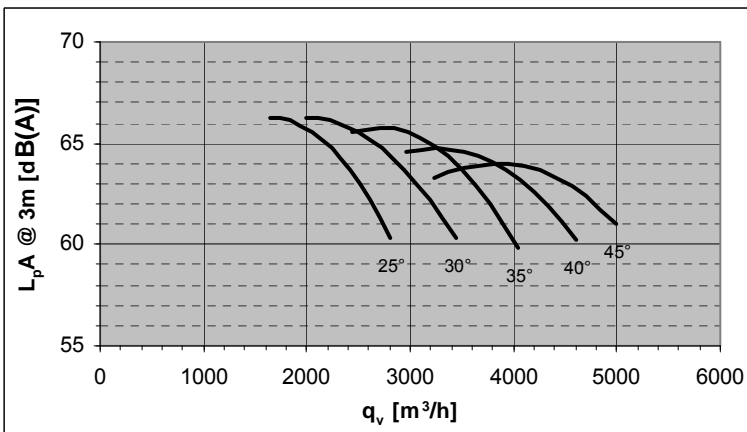
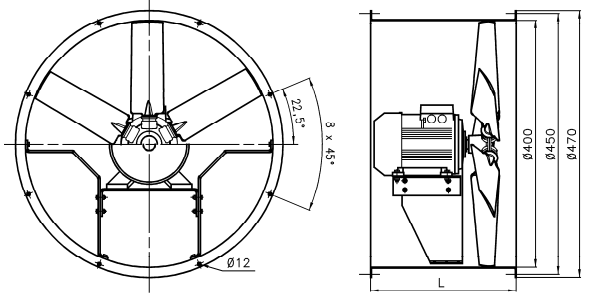

Pitch Angle	Relative spectrum LW dB(A)							
	63	125	250	500	1000	2000	4000	8000
25°	-39	-31	-13	-7	-4	-5	-10	-19
30°	-38	-30	-14	-7	-4	-5	-9	-18
35°	-37	-29	-14	-7	-4	-5	-9	-17
40°	-36	-28	-14	-7	-4	-5	-8	-16
45°	-35	-27	-14	-7	-4	-5	-8	-15

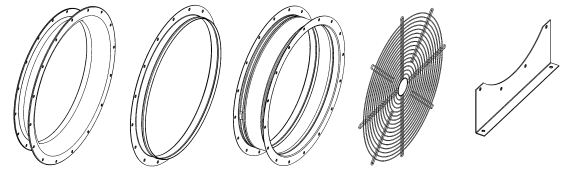

Accessories : see pages 104-106

Design	Pitch Angle	Type (G finish)	Part N°	Type (H finish)	Part N°	L1(mm)	L(mm)	Weight (kg)
K	25°	FV40V-4DK.87.25.G	150132	FV40V-4DK.87.25.H	150133	269	260	15
	30°	FV40V-4DK.97.30.G	150136	FV40V-4DK.97.30.H	150137	296	260	16
	35°	FV40V-4DK.97.35.G	150140	FV40V-4DK.97.35.H	150141	296	260	16
	40°	FV40V-4DK.A7.40.G	150144	FV40V-4DK.A7.40.H	150145	304	260	18
	45°	FV40V-4DK.A7.45.G	150148	FV40V-4DK.A7.45.H	150149	304	260	18
F	25°	FV40V-4DF.87.25.G	150134	FV40V-4DF.87.25.H	150135	---	470	20
	30°	FV40V-4DF.97.30.G	150138	FV40V-4DF.97.30.H	150139	---	470	20
	35°	FV40V-4DF.97.35.G	150142	FV40V-4DF.97.35.H	150143	---	470	21
	40°	FV40V-4DF.A7.40.G	150146	FV40V-4DF.A7.40.H	150147	---	470	22
	45°	FV40V-4DF.A7.45.G	150150	FV40V-4DF.A7.45.H	150151	---	470	22

FV40V-6D



50Hz Motor	U	I	P ₂	n	
	V	A	kW	min ⁻¹	
25°	63 M	400	0,44	0,09*	850
30°	63 M	400	0,44	0,09*	850
35°	63 M	400	0,44	0,09*	850
40°	63 M	400	0,44	0,09*	850
45°	63 M	400	0,44	0,09*	850

*out of IE2 standard scope

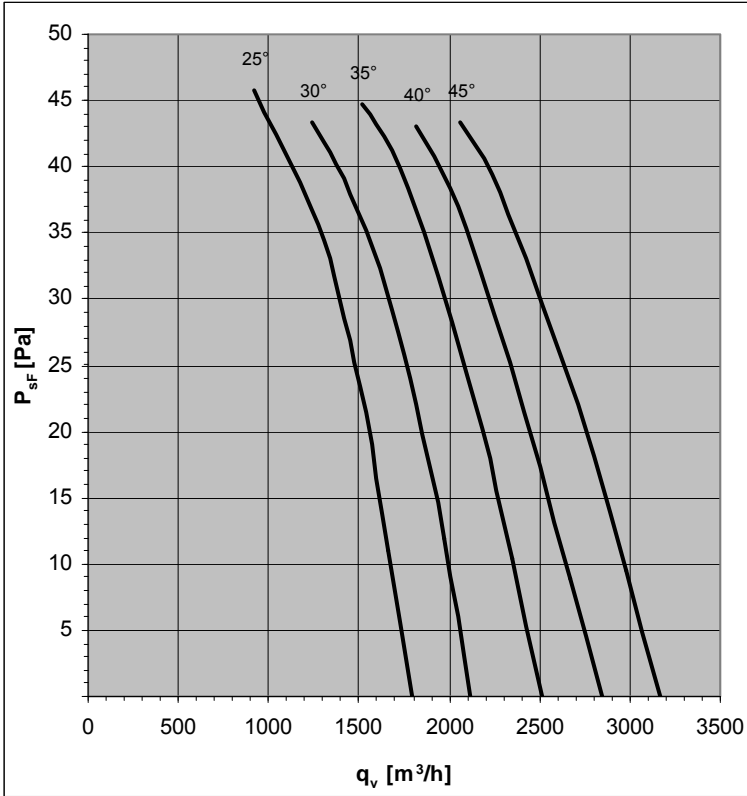

Design K

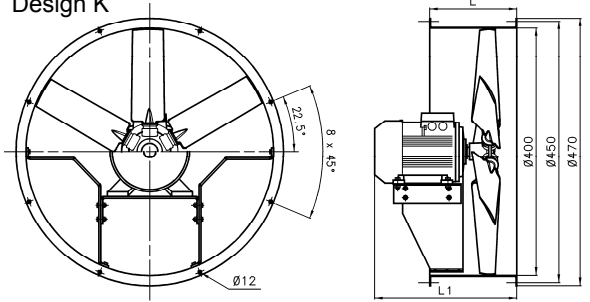

Design F

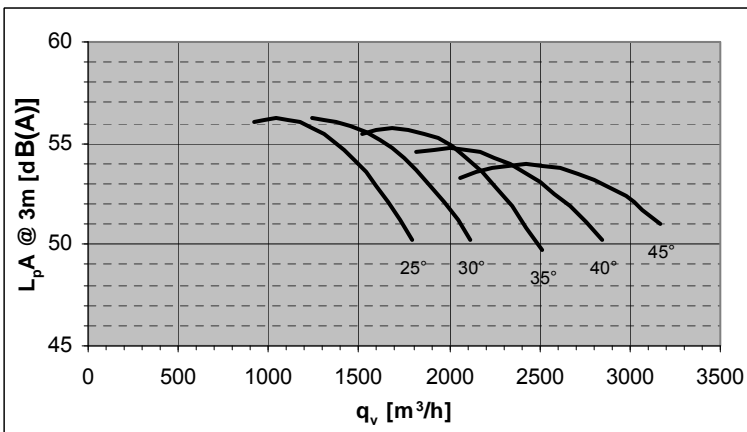
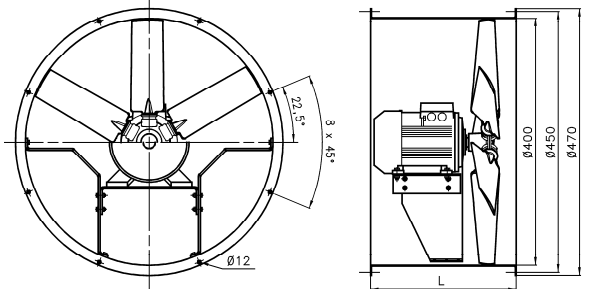

Pitch Angle	Relative spectrum LW dB(A)							
	63	125	250	500	1000	2000	4000	8000
25°	-34	-27	-12	-6	-3	-5	-9	-16
30°	-33	-26	-12	-6	-3	-4	-8	-16
35°	-32	-25	-12	-6	-3	-4	-8	-15
40°	-31	-24	-12	-6	-3	-4	-7	-14
45°	-31	-24	-12	-6	-3	-4	-7	-13

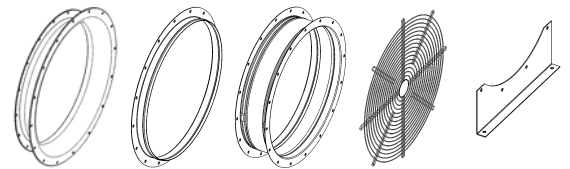

Accessories : see pages 104-106

Design	Pitch Angle	Type (G finish)	Part N°	Type (H finish)	Part N°	L1(mm)	L(mm)	Weight (kg)
K	25°	FV40V-6DK.97.25.G	150152	FV40V-6DK.97.25.H	150153	296	260	16
	30°	FV40V-6DK.97.30.G	150156	FV40V-6DK.97.30.H	150157	296	260	16
	35°	FV40V-6DK.97.35.G	150160	FV40V-6DK.97.35.H	150161	296	260	16
	40°	FV40V-6DK.97.40.G	150164	FV40V-6DK.97.40.H	150165	296	260	16
	45°	FV40V-6DK.97.45.G	150168	FV40V-6DK.97.45.H	150169	296	260	16
F	25°	FV40V-6DF.97.25.G	150154	FV40V-6DF.97.25.H	150155	---	470	21
	30°	FV40V-6DF.97.30.G	150158	FV40V-6DF.97.30.H	150159	---	470	21
	35°	FV40V-6DF.97.35.G	150162	FV40V-6DF.97.35.H	150163	---	470	21
	40°	FV40V-6DF.97.40.G	150166	FV40V-6DF.97.40.H	150167	---	470	21
	45°	FV40V-6DF.97.45.G	150170	FV40V-6DF.97.45.H	150171	---	470	21

FV45V-2D



50Hz Motor	U	I	P ₂	n	
	V	A	kW	min ⁻¹	
25°	90 L	400	4,49	2,2	2890
30°	90 L	400	4,49	2,2	2890
35°	100 L	400	5,88	3	2890
40°	112 M	400	7,65	4	2900
45°	112 M	400	10,3	5,5	2950

Standard Temperature Range : -30°C / +50°C

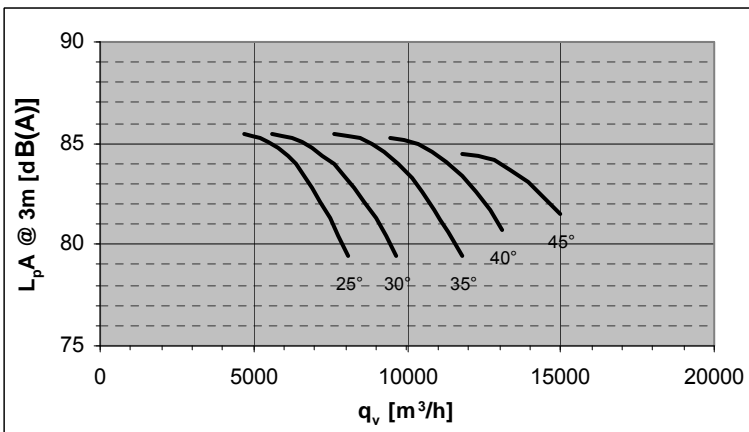
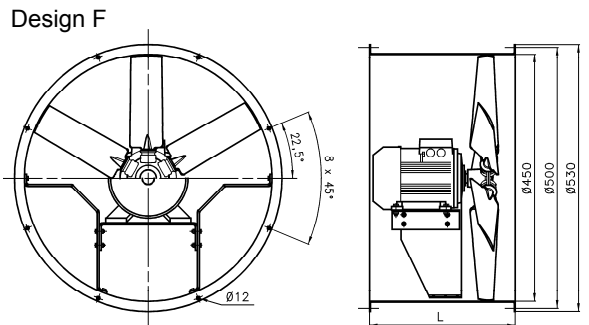
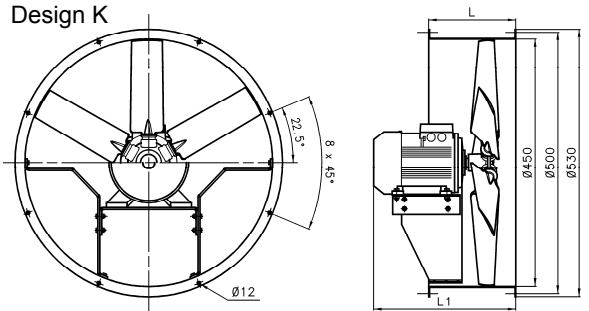
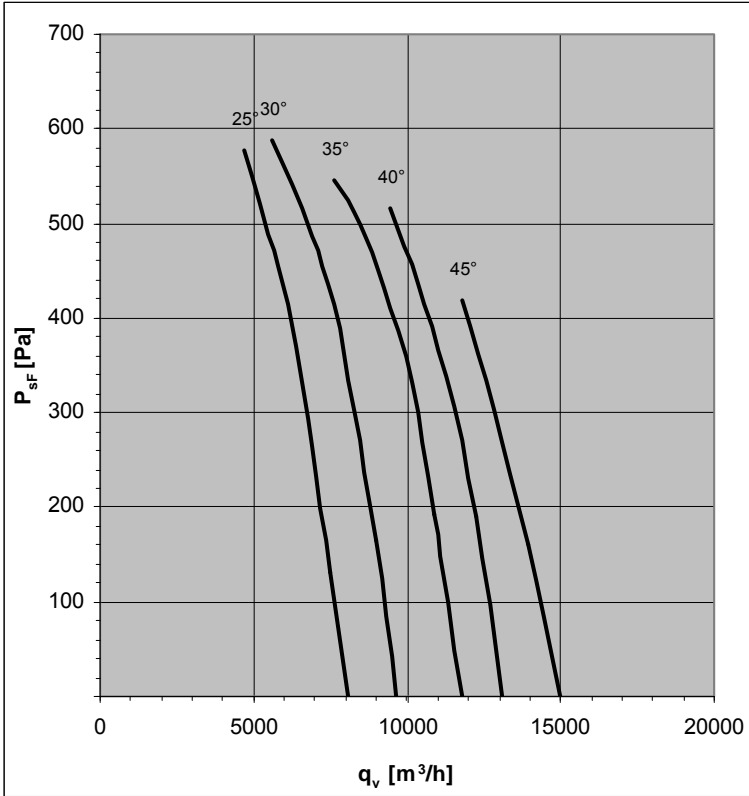

Pitch Angle	Relative spectrum LW dB(A)							
	63	125	250	500	1000	2000	4000	8000
25°	-49	-38	-17	-8	-5	-7	-12	-23
30°	-47	-37	-17	-8	-5	-6	-12	-22
35°	-46	-36	-17	-8	-4	-6	-11	-21
40°	-45	-35	-18	-9	-5	-6	-10	-20
45°	-45	-34	-18	-9	-5	-6	-10	-19

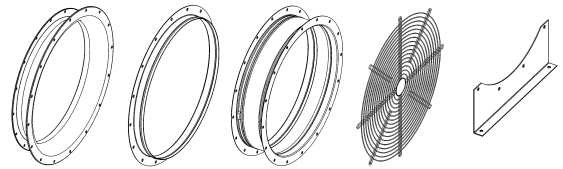

Accessories : see pages 104-106

Design	Pitch Angle	Type (G finish)	Part N°	Type (H finish)	Part N°	L1(mm)	L(mm)	Weight (kg)
K	25°	FV45V-2DK.D7.25.G	150192	FV45V-2DK.D7.25.H	150193	402	260	38
	30°	FV45V-2DK.D7.30.G	150196	FV45V-2DK.D7.30.H	150197	402	260	38
	35°	FV45V-2DK.E7.35.G	150200	FV45V-2DK.E7.35.H	150201	449	260	45
	40°	FV45V-2DK.F7.40.G	150204	FV45V-2DK.F7.40.H	150205	467	385	56
	45°	FV45V-2DK.F7.45.G	150208	FV45V-2DK.F7.45.H	150209	541	385	71
F	25°	FV45V-2DF.D7.25.G	150194	FV45V-2DF.D7.25.H	150195	---	470	43
	30°	FV45V-2DF.D7.30.G	150198	FV45V-2DF.D7.30.H	150199	---	470	43
	35°	FV45V-2DF.E7.35.G	150202	FV45V-2DF.E7.35.H	150203	---	470	50
	40°	FV45V-2DF.F7.40.G	150206	FV45V-2DF.F7.40.H	150207	---	530	60
	45°	FV45V-2DF.F7.45.G	150210	FV45V-2DF.F7.45.H	150211	---	530	75

FV45V-4D



50Hz Motor	U	I	P ₂	n
	V	A	kW	min ⁻¹
25°	63 M	400	0,18*	1350
30°	71 M	400	0,77	1350
35°	71 M	400	1,06	1370
40°	71 M	400	1,06	1370
45°	80 M	400	1,46	1395

*out of IE2 standard scope

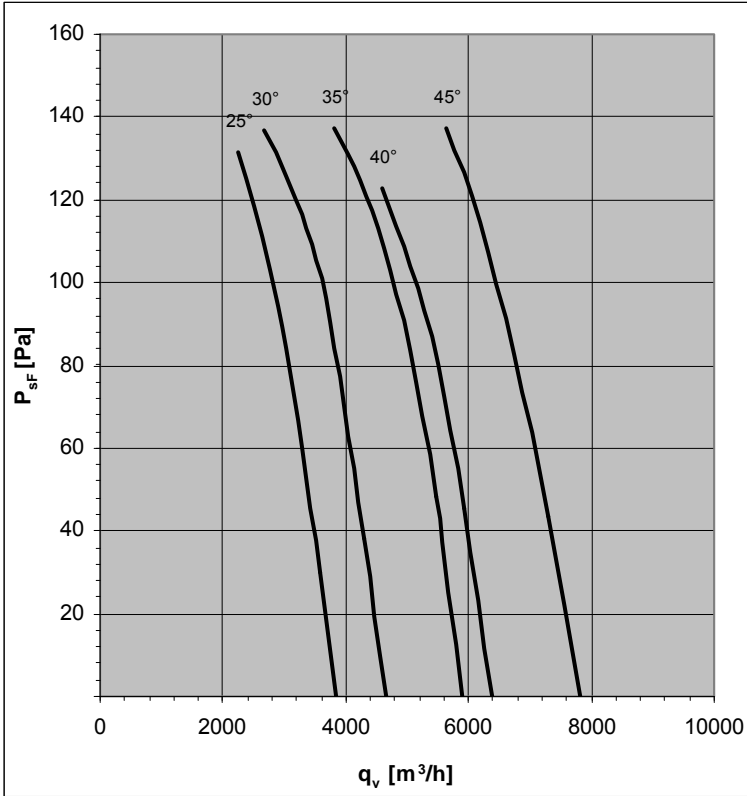

Design K

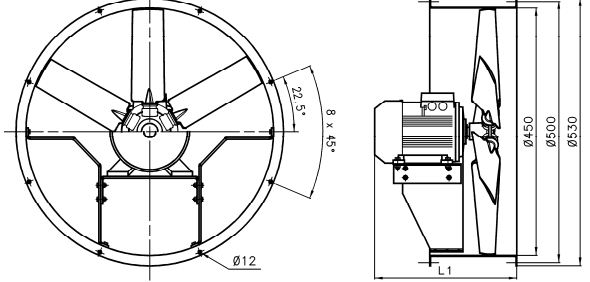

Design F

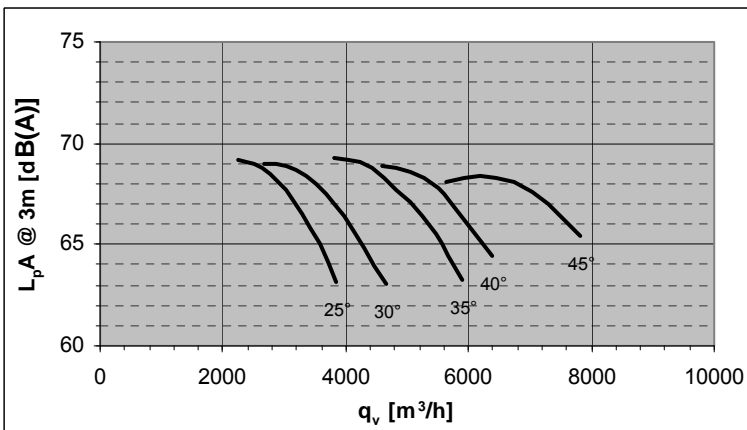
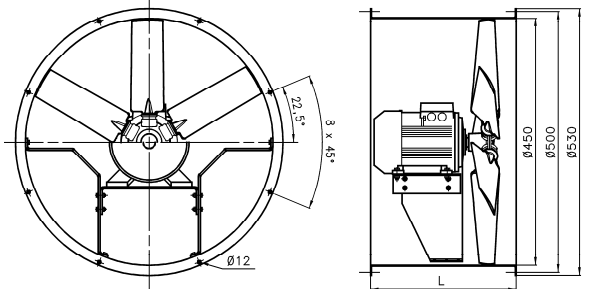

Pitch Angle	Relative spectrum LW dB(A)							
	63	125	250	500	1000	2000	4000	8000
25°	-40	-32	-14	-7	-4	-6	-10	-20
30°	-39	-31	-14	-7	-4	-5	-10	-18
35°	-38	-30	-14	-7	-4	-5	-9	-17
40°	-38	-29	-15	-7	-4	-5	-9	-17
45°	-37	-29	-15	-7	-4	-5	-8	-16

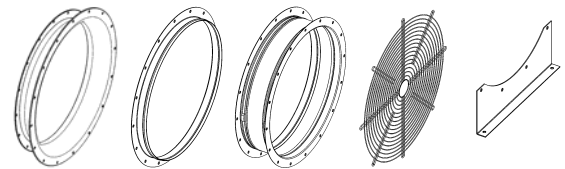

Accessories : see pages 104-106

Design	Pitch Angle	Type (G finish)	Part N°	Type (H finish)	Part N°	L1(mm)	L(mm)	Weight (kg)
K	25°	FV45V-4DK.97.25.G	150212	FV45V-4DK.97.25.H	150213	298	260	20
	30°	FV45V-4DK.A7.30.G	150216	FV45V-4DK.A7.30.H	150217	309	260	21
	35°	FV45V-4DK.A7.35.G	150220	FV45V-4DK.A7.35.H	150221	309	260	22
	40°	FV45V-4DK.A7.40.G	150224	FV45V-4DK.A7.40.H	150225	309	260	22
	45°	FV45V-4DK.B7.45.G	150228	FV45V-4DK.B7.45.H	150229	343	260	25
F	25°	FV45V-4DF.97.25.G	150214	FV45V-4DF.97.25.H	150215	---	470	25
	30°	FV45V-4DF.A7.30.G	150218	FV45V-4DF.A7.30.H	150219	---	470	26
	35°	FV45V-4DF.A7.35.G	150222	FV45V-4DF.A7.35.H	150223	---	470	27
	40°	FV45V-4DF.A7.40.G	150226	FV45V-4DF.A7.40.H	150227	---	470	27
	45°	FV45V-4DF.B7.45.G	150230	FV45V-4DF.B7.45.H	150231	---	470	30

FV45V-6D



50Hz Motor	U	I	P ₂	n	
	V	A	kW	min ⁻¹	
25°	63 M	400	0,44	0,09*	850
30°	63 M	400	0,44	0,09*	850
35°	63 M	400	0,44	0,09*	850
40°	63 M	400	0,44	0,09*	850
45°	71 M	400	0,72	0,18*	850

*out of IE2 standard scope

Standard Temperature Range : -30°C / +50°C

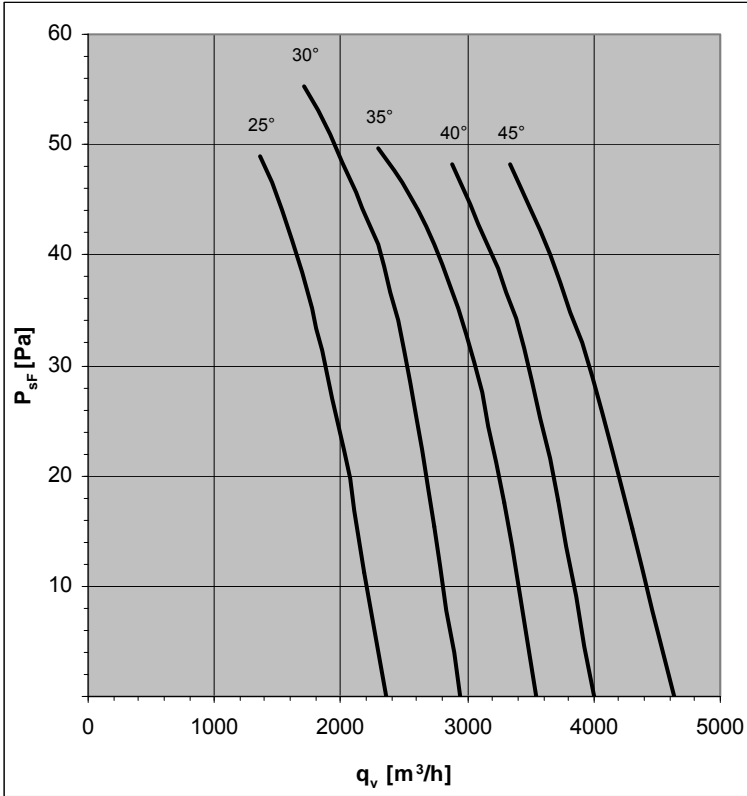

Design K

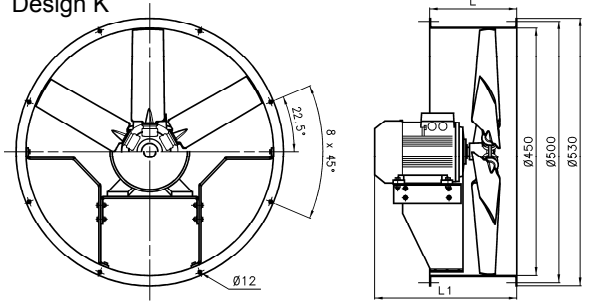

Design F

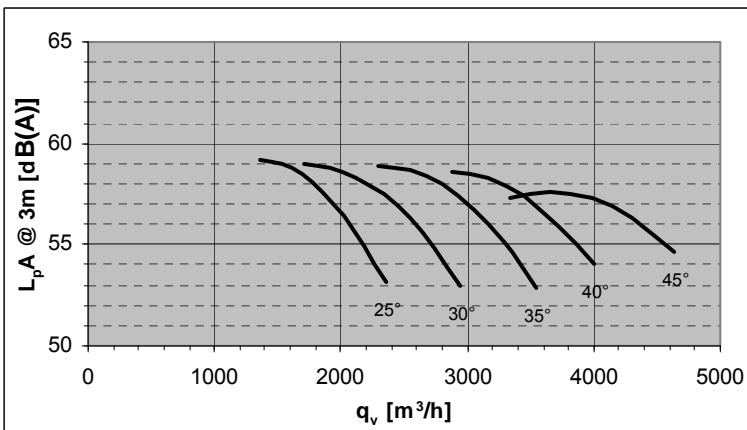
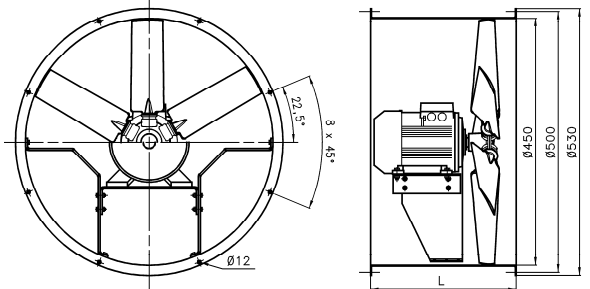

Pitch Angle	Relative spectrum LW dB(A)							
	63	125	250	500	1000	2000	4000	8000
25°	-35	-28	-12	-6	-3	-5	-9	-17
30°	-34	-27	-12	-6	-3	-5	-8	-16
35°	-33	-26	-12	-6	-3	-4	-8	-15
40°	-33	-26	-13	-6	-3	-4	-7	-15
45°	-32	-25	-13	-6	-3	-4	-7	-14

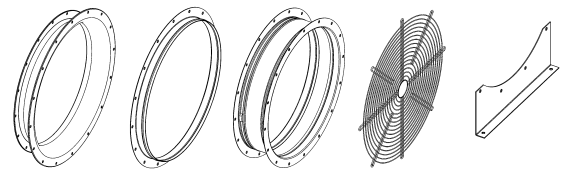

Accessories : see pages 104-106

Design	Pitch Angle	Type (G finish)	Part N°	Type (H finish)	Part N°	L1(mm)	L(mm)	Weight (kg)
K	25°	FV45V-6DK.97.25.G	150232	FV45V-6DK.97.25.H	150233	298	260	20
	30°	FV45V-6DK.97.30.G	150236	FV45V-6DK.97.30.H	150237	298	260	20
	35°	FV45V-6DK.97.35.G	150240	FV45V-6DK.97.35.H	150241	298	260	20
	40°	FV45V-6DK.97.40.G	150244	FV45V-6DK.97.40.H	150245	298	260	20
	45°	FV45V-6DK.A7.45.G	150248	FV45V-6DK.A7.45.H	150249	309	260	21
F	25°	FV45V-6DF.97.25.G	150234	FV45V-6DF.97.25.H	150235	---	470	25
	30°	FV45V-6DF.97.30.G	150238	FV45V-6DF.97.30.H	150239	---	470	25
	35°	FV45V-6DF.97.35.G	150242	FV45V-6DF.97.35.H	150243	---	470	25
	40°	FV45V-6DF.97.40.G	150246	FV45V-6DF.97.40.H	150247	---	470	25
	45°	FV45V-6DF.A7.45.G	150250	FV45V-6DF.A7.45.H	150251	---	470	26

FV50V-2D



50Hz Motor	U	I	P ₂	n	
	V	A	kW	min ⁻¹	
25°	90 L	400	4,49	2,2	2890
30°	100 L	400	5,88	3	2890
35°	132 S	400	10,4	5,5	2930
40°	132 S	400	10,4	5,5	2930
45°	132 S	400	14	7,5	2930

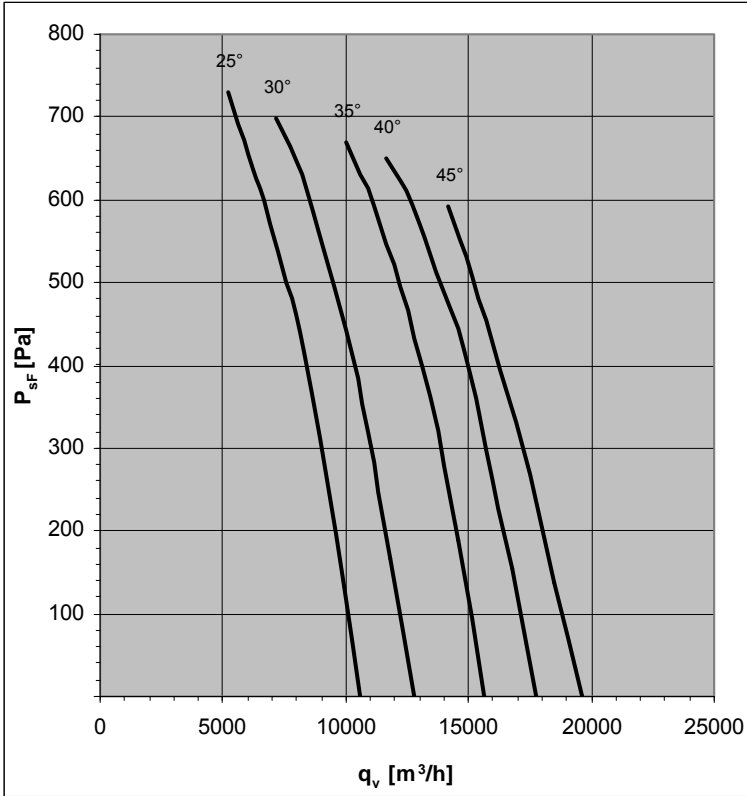

Design K

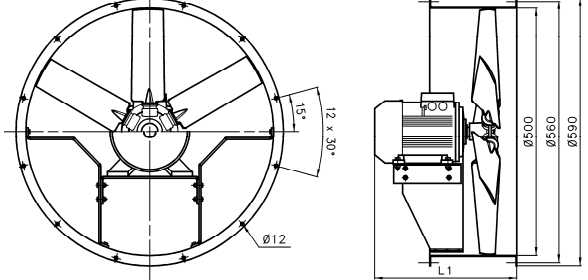

Design F

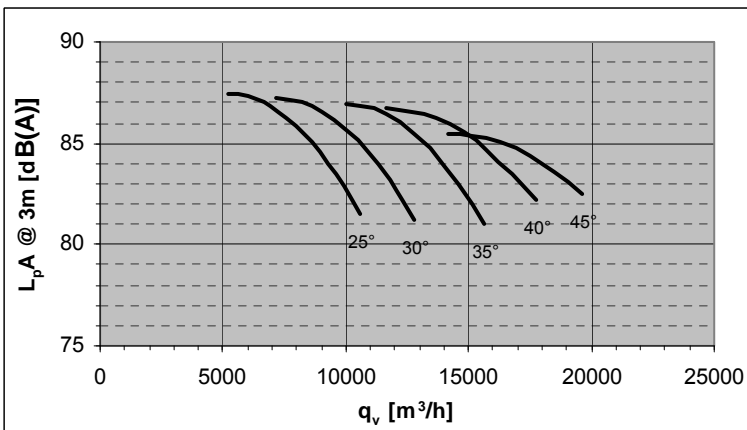
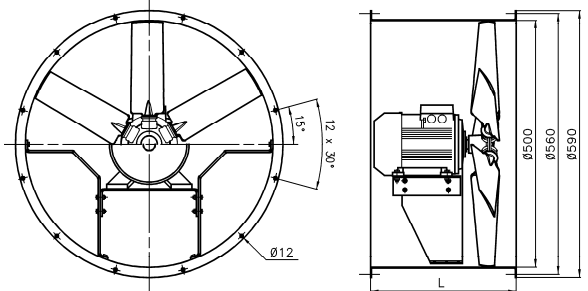

Pitch Angle	Relative spectrum LW dB(A)							
	63	125	250	500	1000	2000	4000	8000
25°	-50	-39	-17	-8	-5	-7	-13	-24
30°	-48	-38	-17	-8	-5	-7	-12	-23
35°	-47	-37	-17	-9	-5	-6	-11	-21
40°	-46	-36	-18	-9	-5	-6	-10	-20
45°	-45	-35	-18	-9	-5	-6	-10	-19

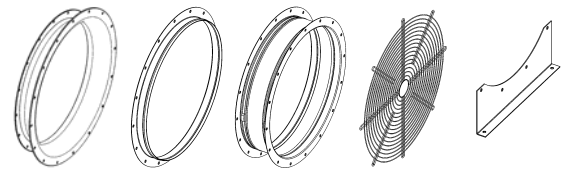

Accessories : see pages 104-106

Design	Pitch Angle	Type (G finish)	Part N°	Type (H finish)	Part N°	L1(mm)	L(mm)	Weight (kg)
K	25°	FV50V-2DK.D7.25.G	150265	FV50V-2DK.D7.25.H	150266	402	260	40
	30°	FV50V-2DK.E7.30.G	150269	FV50V-2DK.E7.30.H	150270	449	260	47
	35°	FV50V-2DK.G7.35.G	150273	FV50V-2DK.G7.35.H	150274	541	385	73
	40°	FV50V-2DK.G7.40.G	150277	FV50V-2DK.G7.40.H	150278	541	385	73
	45°	FV50V-2DK.G7.45.G	150281	FV50V-2DK.G7.45.H	150282	541	385	79
F	25°	FV50V-2DF.D7.25.G	150267	FV50V-2DF.D7.25.H	150268	---	470	45
	30°	FV50V-2DF.E7.30.G	150271	FV50V-2DF.E7.30.H	150272	---	470	52
	35°	FV50V-2DF.G7.35.G	150275	FV50V-2DF.G7.35.H	150276	---	540	78
	40°	FV50V-2DF.G7.40.G	150279	FV50V-2DF.G7.40.H	150280	---	540	78
	45°	FV50V-2DF.G7.45.G	150283	FV50V-2DF.G7.45.H	150284	---	540	83

FV50V-4D



50Hz Motor	U	I	P ₂	n	
	V	A	kW	min ⁻¹	
25°	71 M	400	0,77	0,25*	1350
30°	71 M	400	1,06	0,37*	1370
35°	80 M	400	1,46	0,55*	1395
40°	80 M	400	1,81	0,75	1400
45°	80 M	400	1,81	0,75	1400

*out of IE2 standard scope

Standard Temperature Range : -30°C / +50°C

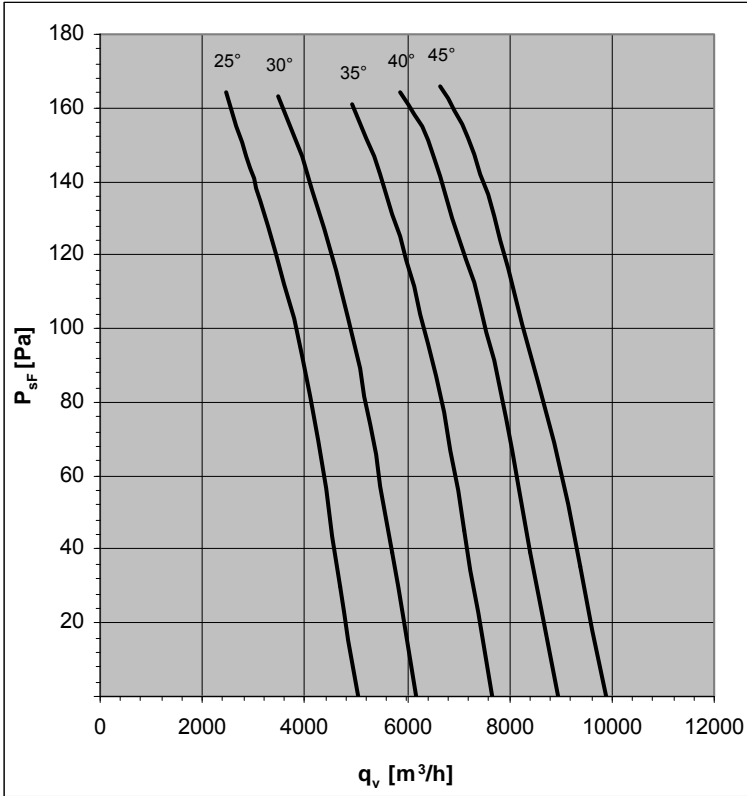

Design K

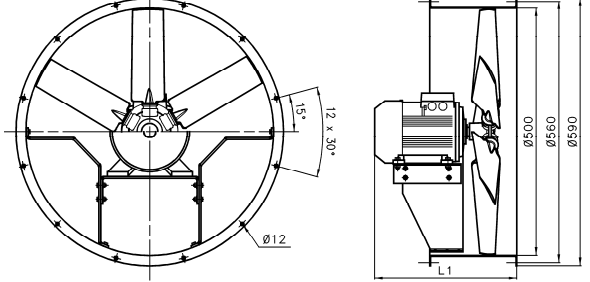

Design F

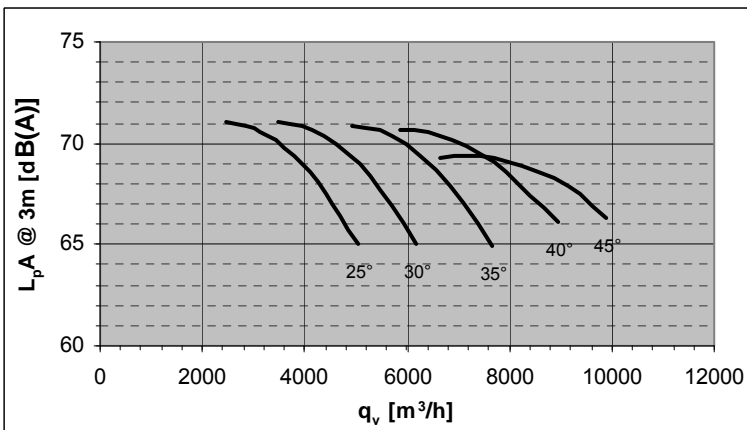
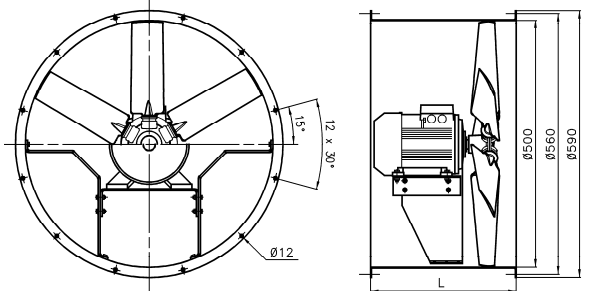

Pitch Angle	Relative spectrum LW dB(A)							
	63	125	250	500	1000	2000	4000	8000
25°	-41	-33	-14	-7	-4	-6	-11	-20
30°	-40	-32	-14	-7	-4	-5	-10	-19
35°	-39	-31	-15	-7	-4	-5	-9	-18
40°	-39	-30	-15	-7	-4	-5	-9	-17
45°	-38	-29	-15	-7	-4	-5	-8	-16

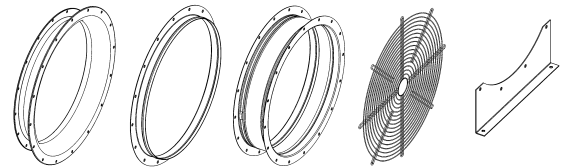

Accessories : see pages 104-106

Design	Pitch Angle	Type (G finish)	Part N°	Type (H finish)	Part N°	L1(mm)	L(mm)	Weight (kg)
K	25°	FV50V-4DK.A7.25.G	150285	FV50V-4DK.A7.25.H	150286	309	260	23
	30°	FV50V-4DK.A7.30.G	150289	FV50V-4DK.A7.30.H	150290	309	260	24
	35°	FV50V-4DK.B7.35.G	150293	FV50V-4DK.B7.35.H	150294	343	260	27
	40°	FV50V-4DK.B7.40.G	150297	FV50V-4DK.B7.40.H	150298	379	260	30
	45°	FV50V-4DK.B7.45.G	150301	FV50V-4DK.B7.45.H	150302	379	260	30
F	25°	FV50V-4DF.A7.25.G	150287	FV50V-4DF.A7.25.H	150288	---	470	28
	30°	FV50V-4DF.A7.30.G	150291	FV50V-4DF.A7.30.H	150292	---	470	29
	35°	FV50V-4DF.B7.35.G	150295	FV50V-4DF.B7.35.H	150296	---	470	32
	40°	FV50V-4DF.B7.40.G	150299	FV50V-4DF.B7.40.H	150300	---	470	36
	45°	FV50V-4DF.B7.45.G	150303	FV50V-4DF.B7.45.H	150304	---	470	36

FV50V-6D



50Hz Motor	U	I	P ₂	n	
	V	A	kW	min ⁻¹	
25°	63 M	400	0,44	0,09*	850
30°	63 M	400	0,44	0,09*	850
35°	71 M	400	0,72	0,18*	850
40°	71 M	400	0,72	0,18*	850
45°	71 M	400	0,72	0,18*	850

*out of IE2 standard scope

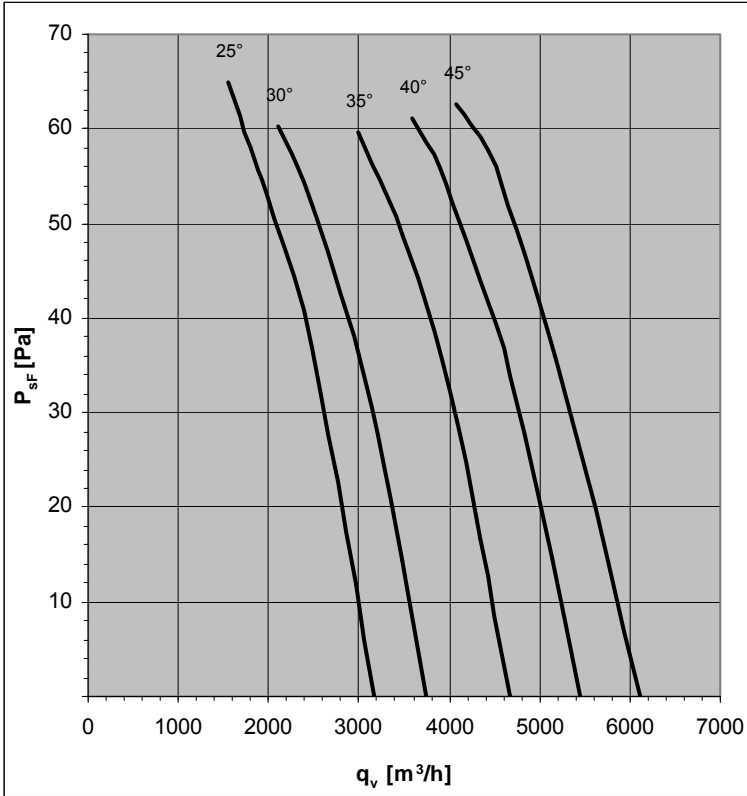

Design K

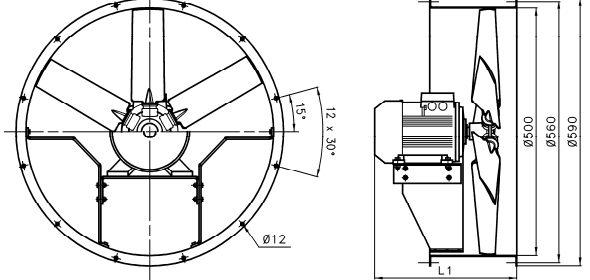

Design F

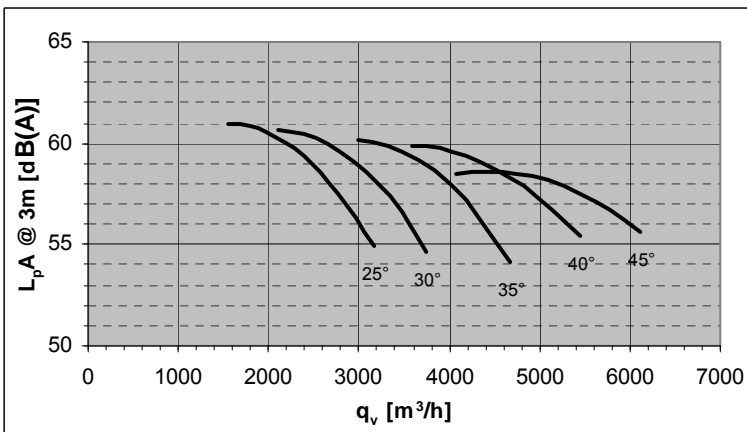
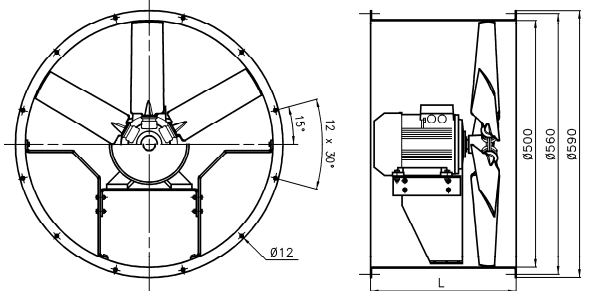

Pitch Angle	Relative spectrum LW dB(A)							
	63	125	250	500	1000	2000	4000	8000
25°	-36	-29	-13	-6	-3	-5	-9	-18
30°	-35	-28	-13	-6	-3	-5	-9	-17
35°	-34	-27	-13	-6	-3	-5	-8	-16
40°	-34	-26	-13	-6	-3	-4	-8	-15
45°	-33	-25	-13	-6	-3	-4	-7	-14

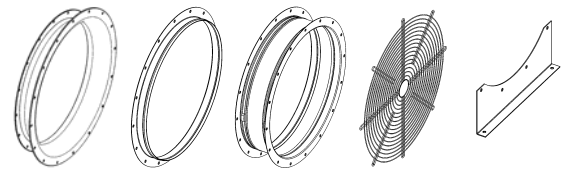

Accessories : see pages 104-106

Design	Pitch Angle	Type (G finish)	Part N°	Type (H finish)	Part N°	L1(mm)	L(mm)	Weight (kg)
K	25°	FV50V-6DK.97.25.G	150305	FV50V-6DK.97.25.H	150306	298	260	22
	30°	FV50V-6DK.97.30.G	150309	FV50V-6DK.97.30.H	150310	298	260	22
	35°	FV50V-6DK.A7.35.G	150313	FV50V-6DK.A7.35.H	150314	309	260	23
	40°	FV50V-6DK.A7.40.G	150317	FV50V-6DK.A7.40.H	150318	309	260	23
	45°	FV50V-6DK.A7.45.G	150321	FV50V-6DK.A7.45.H	150322	309	260	23
F	25°	FV50V-6DF.97.25.G	150307	FV50V-6DF.97.25.H	150308	---	470	28
	30°	FV50V-6DF.97.30.G	150311	FV50V-6DF.97.30.H	150312	---	470	28
	35°	FV50V-6DF.A7.35.G	150315	FV50V-6DF.A7.35.H	150316	---	470	28
	40°	FV50V-6DF.A7.40.G	150319	FV50V-6DF.A7.40.H	150320	---	470	28
	45°	FV50V-6DF.A7.45.G	150323	FV50V-6DF.A7.45.H	150324	---	470	28

FV56V-2D



50Hz Motor	U	I	P ₂	n	
	V	A	kW	min ⁻¹	
25°	100 L	400	5,88	3	2890
30°	112 M	400	7,65	4	2900
35°	132 S	400	10,4	5,5	2930
40°	132 S	400	14	7,5	2930
		400			

Standard Temperature Range : -30°C / +50°C

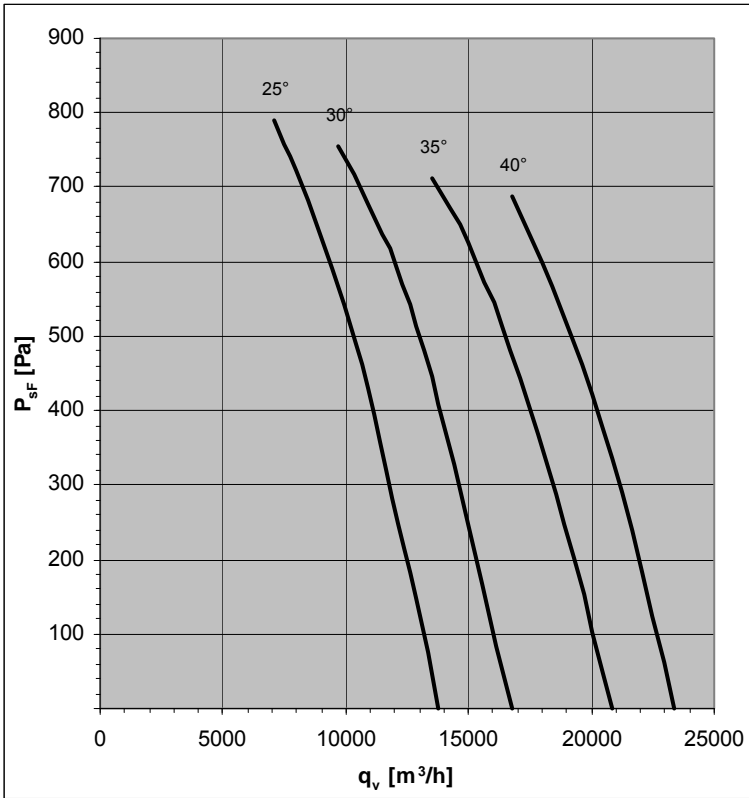

Design K

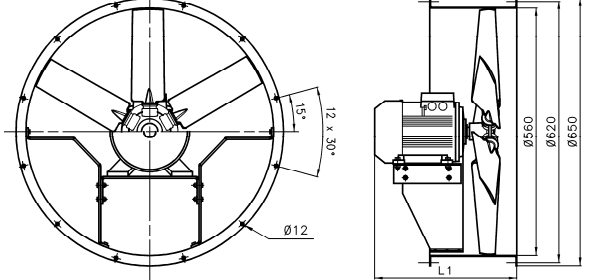

Design F

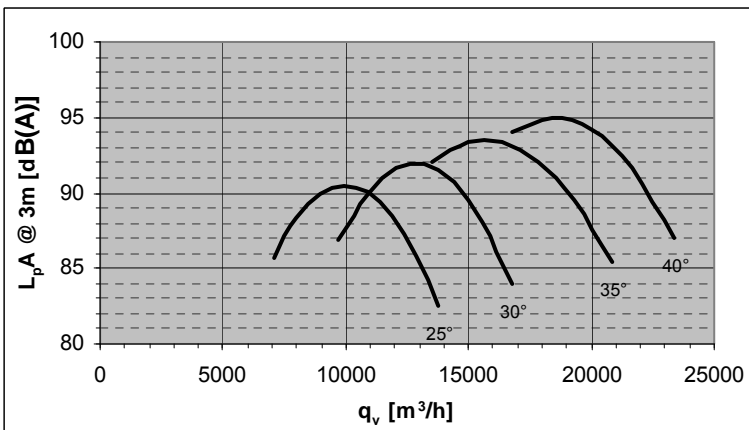
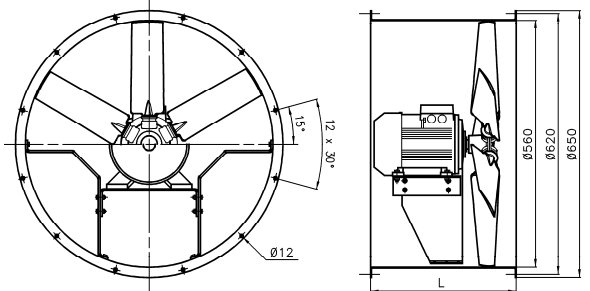

Pitch Angle	Relative spectrum LW dB(A)							
	63	125	250	500	1000	2000	4000	8000
25°	-50	-40	-17	-8	-5	-7	-13	-24
30°	-49	-39	-18	-9	-5	-7	-12	-23
35°	-49	-38	-18	-9	-5	-7	-12	-22
40°	-48	-38	-19	-9	-5	-6	-11	-21

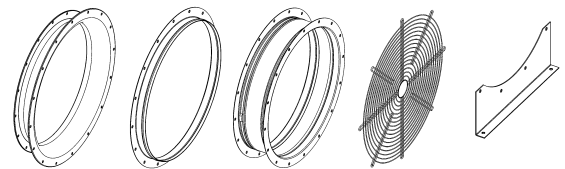

Accessories : see pages 104-106

Design	Pitch Angle	Type (G finish)	Part N°	Type (H finish)	Part N°	L1(mm)	L(mm)	Weight (kg)
K	25°	FV56V-2DK.E7.25.G	151002	FV56V-2DK.E7.25.H	151003	449	260	49
	30°	FV56V-2DK.F7.30.G	151006	FV56V-2DK.F7.30.H	151007	467	385	62
	35°	FV56V-2DK.G7.35.G	151010	FV56V-2DK.G7.35.H	151011	541	385	77
	40°	FV56V-2DK.G7.40.G	151014	FV56V-2DK.G7.40.H	151015	541	385	83
F	25°	FV56V-2DF.E7.25.G	151004	FV56V-2DF.E7.25.H	151005	---	470	55
	30°	FV56V-2DF.F7.30.G	151008	FV56V-2DF.F7.30.H	151009	---	540	67
	35°	FV56V-2DF.G7.35.G	151012	FV56V-2DF.G7.35.H	151013	---	540	82
	40°	FV56V-2DF.G7.40.G	151016	FV56V-2DF.G7.40.H	151017	---	540	88

FV56V-4D



50Hz Motor	U	I	P ₂	n
	V	A	kW	min ⁻¹
30°	80 M	400	1,46	0,55* 1395
35°	80 M	400	1,81	0,75 1400
40°	90 S	400	2,53	1,1 1430
45°	90 S	400	2,53	1,1 1430
50°	90 L	400	3,31	1,5 1430

*out of IE2 standard scope

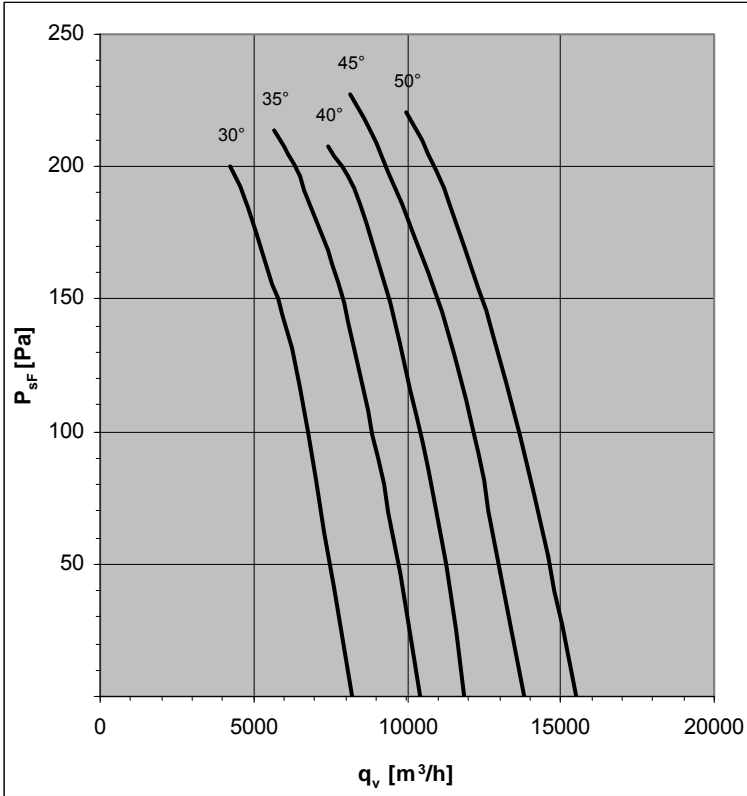

Design K

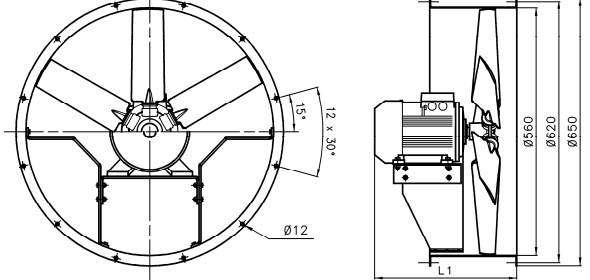

Design F

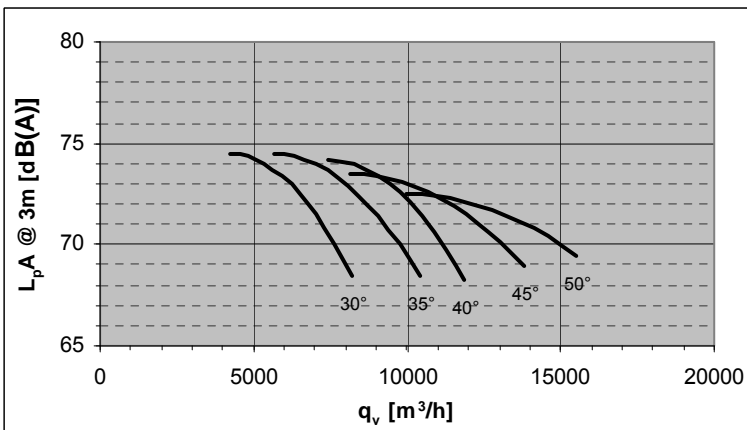
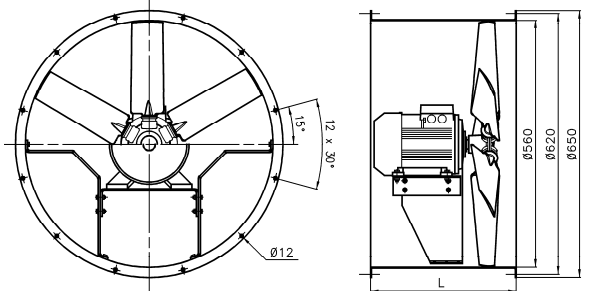

Pitch Angle	Relative spectrum LW dB(A)							
	63	125	250	500	1000	2000	4000	8000
30°	-43	-34	-15	-7	-4	-6	-11	-21
35°	-42	-33	-15	-7	-4	-6	-10	-20
40°	-41	-32	-15	-7	-4	-5	-10	-19
45°	-40	-31	-15	-8	-4	-5	-9	-18
50°	-39	-30	-16	-8	-4	-5	-8	-17

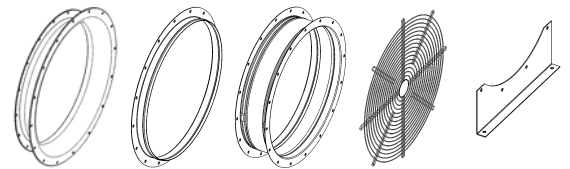

Accessories : see pages 104-106

Design	Pitch Angle	Type (G finish)	Part N°	Type (H finish)	Part N°	L1(mm)	L(mm)	Weight (kg)
K	30°	FV56V-4DK.B7.30.G	150341	FV56V-4DK.B7.30.H	150342	343	260	29
	35°	FV56V-4DK.B7.35.G	150345	FV56V-4DK.B7.35.H	150346	379	260	32
	40°	FV56V-4DK.C7.40.G	150349	FV56V-4DK.C7.40.H	150350	377	260	38
	45°	FV56V-4DK.C7.45.G	150353	FV56V-4DK.C7.45.H	150354	377	260	38
	50°	FV56V-4DK.D7.50.G	150357	FV56V-4DK.D7.50.H	150358	402	260	41
F	30°	FV56V-4DF.B7.30.G	150343	FV56V-4DF.B7.30.H	150344	---	470	35
	35°	FV56V-4DF.B7.35.G	150347	FV56V-4DF.B7.35.H	150348	---	470	39
	40°	FV56V-4DF.C7.40.G	150351	FV56V-4DF.C7.40.H	150352	---	470	45
	45°	FV56V-4DF.C7.45.G	150355	FV56V-4DF.C7.45.H	150356	---	470	45
	50°	FV56V-4DF.D7.50.G	150359	FV56V-4DF.D7.50.H	150360	---	470	47

FV56V-6D



50Hz Motor	U	I	P ₂	n
	V	A	kW	min ⁻¹
30°	71 M	400	0,18*	850
35°	71 M	400	0,18*	850
40°	71 M	400	0,25*	830
45°	71 M	400	0,25*	830
50°	80 M	400	1,2	920

*out of IE2 standard scope

Standard Temperature Range : -30°C / +50°C

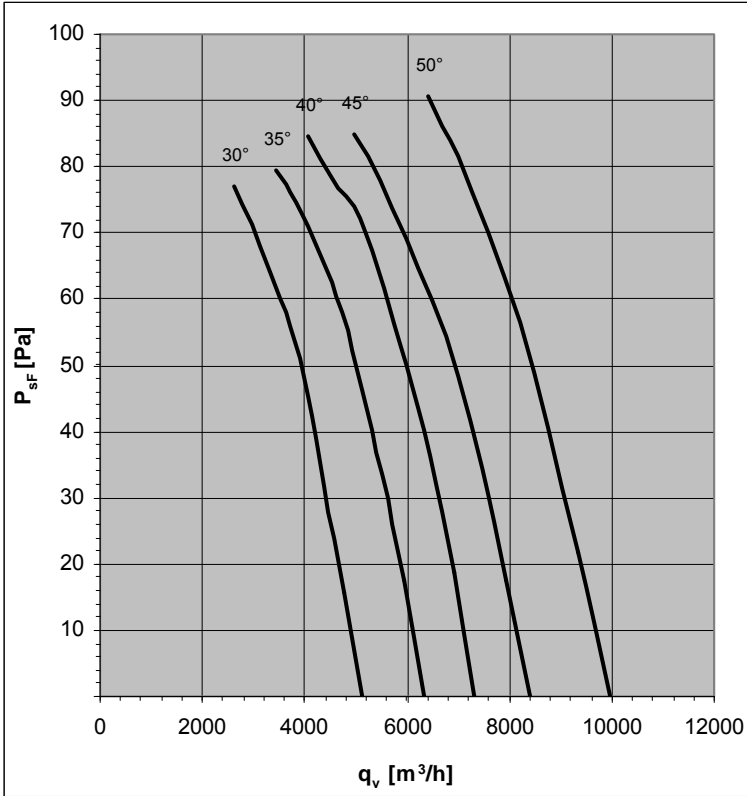

Design K

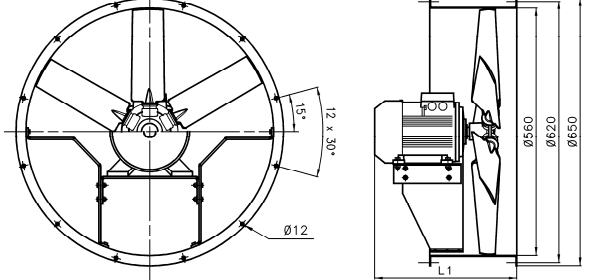

Design F

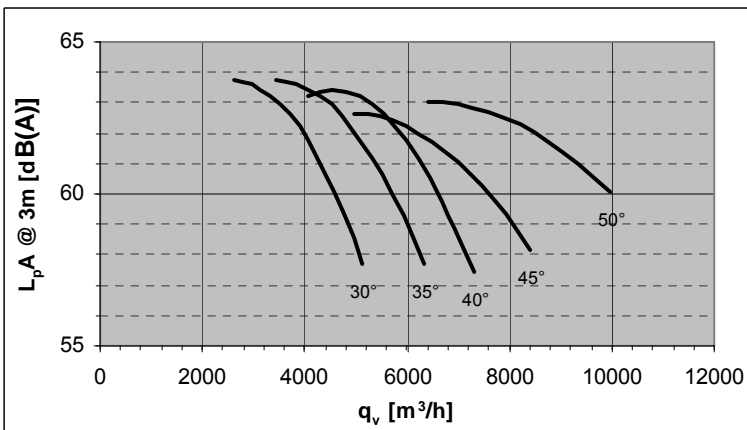
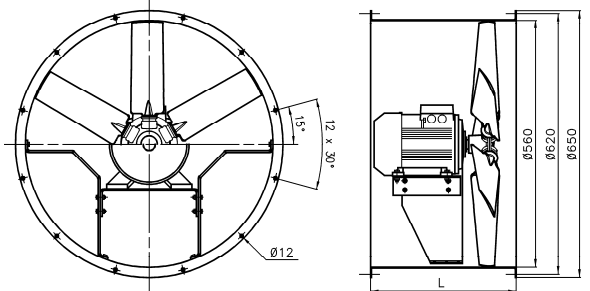

Pitch Angle	Relative spectrum LW dB(A)							
	63	125	250	500	1000	2000	4000	8000
30°	-38	-30	-13	-6	-4	-5	-10	-18
35°	-37	-29	-13	-6	-3	-5	-9	-17
40°	-36	-28	-13	-6	-3	-5	-8	-16
45°	-35	-27	-13	-7	-3	-5	-8	-15
50°	-35	-27	-14	-7	-4	-5	-8	-15

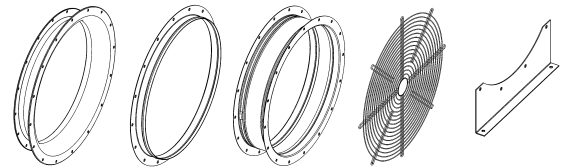

Accessories : see pages 104-106

Design	Pitch Angle	Type (G finish)	Part N°	Type (H finish)	Part N°	L1(mm)	L(mm)	Weight (kg)
K	30°	FV56V-6DK.A7.30.G	150361	FV56V-6DK.A7.30.H	150362	309	260	25
	35°	FV56V-6DK.A7.35.G	150365	FV56V-6DK.A7.35.H	150366	309	260	25
	40°	FV56V-6DK.A7.40.G	150369	FV56V-6DK.A7.40.H	150370	309	260	26
	45°	FV56V-6DK.A7.45.G	150373	FV56V-6DK.A7.45.H	150374	309	260	26
	50°	FV56V-6DK.B7.50.G	150377	FV56V-6DK.B7.50.H	150378	343	260	29
F	30°	FV56V-6DF.A7.30.G	150363	FV56V-6DF.A7.30.H	150364	---	470	31
	35°	FV56V-6DF.A7.35.G	150367	FV56V-6DF.A7.35.H	150368	---	470	31
	40°	FV56V-6DF.A7.40.G	150371	FV56V-6DF.A7.40.H	150372	---	470	33
	45°	FV56V-6DF.A7.45.G	150375	FV56V-6DF.A7.45.H	150376	---	470	33
	50°	FV56V-6DF.B7.50.G	150379	FV56V-6DF.B7.50.H	150380	---	470	35

FV63V-2D



50Hz Motor	U	I	P ₂	n	
	V	A	kW	min ⁻¹	
25°	112 M	400	7,65	4	2900
30°	132 S	400	10,4	5,5	2930
35°	132 S	400	14	7,5	2930
		400			
		400			

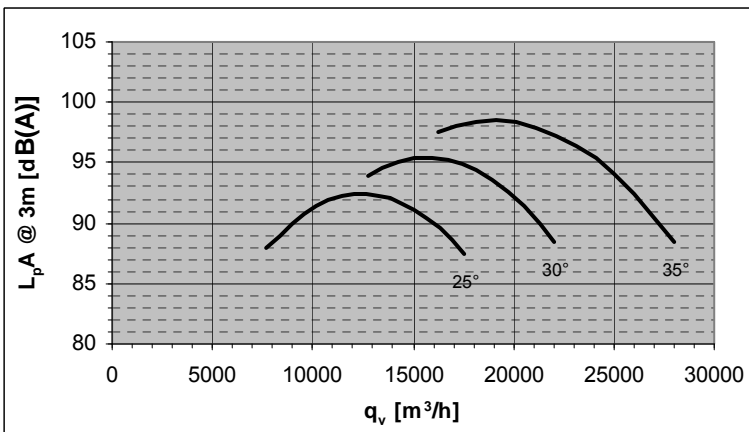
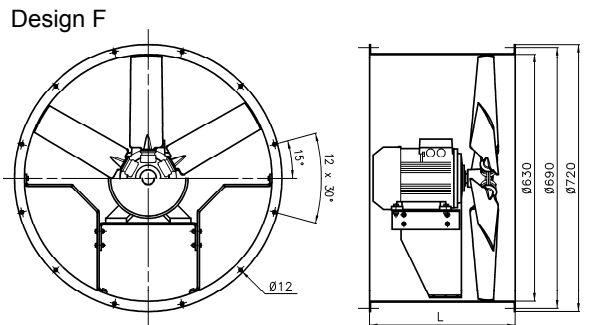
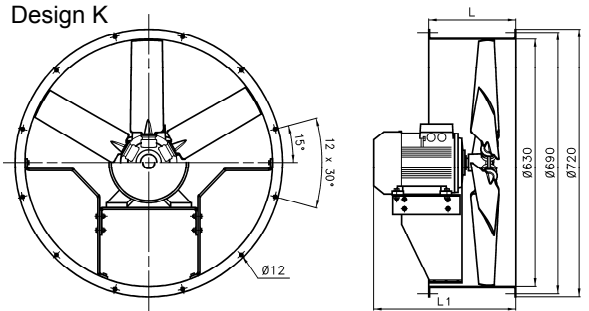
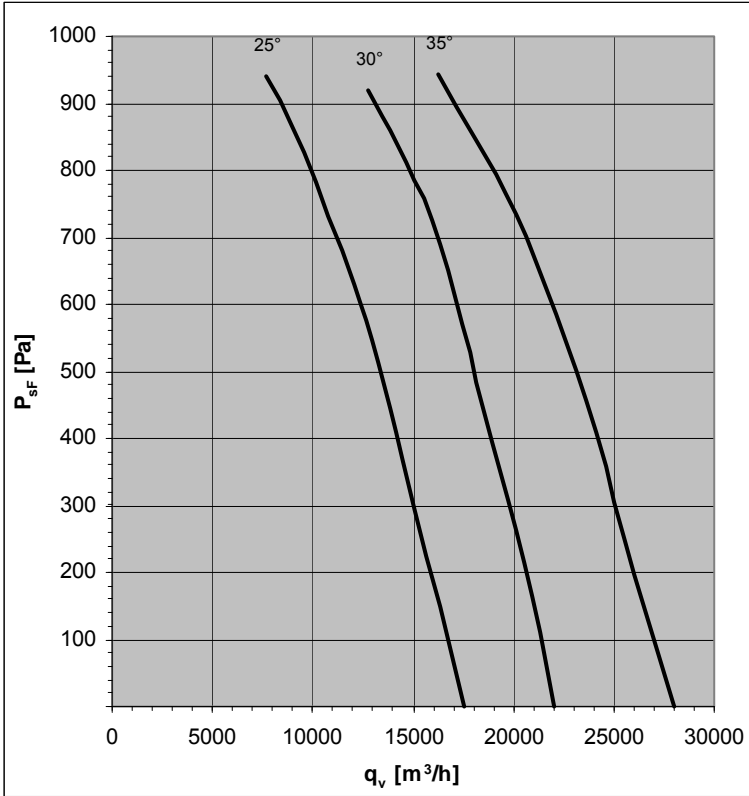

Pitch Angle	Relative spectrum LW dB(A)							
	63	125	250	500	1000	2000	4000	8000
25°	-53	-41	-18	-9	-5	-7	-13	-25
30°	-52	-41	-19	-9	-5	-7	-13	-24
35°	-50	-39	-19	-9	-5	-7	-12	-23

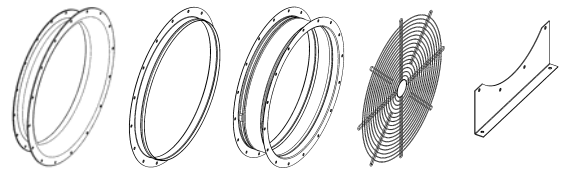

Accessories : see pages 104-106

Design	Pitch Angle	Type (G finish)	Part N°	Type (H finish)	Part N°	L1(mm)	L(mm)	Weight (kg)
K	25°	FV63V-2DK.F7.25.G	151030	FV63V-2DK.F7.25.H	151031	467	385	65
	30°	FV63V-2DK.G7.30.G	151034	FV63V-2DK.G7.30.H	151035	541	385	80
	35°	FV63V-2DK.G7.35.G	151038	FV63V-2DK.G7.35.H	151039	541	385	86
F	25°	FV63V-2DF.F7.25.G	151032	FV63V-2DF.F7.25.H	151033	---	540	71
	30°	FV63V-2DF.G7.30.G	151036	FV63V-2DF.G7.30.H	151037	---	540	86
	35°	FV63V-2DF.G7.35.G	151040	FV63V-2DF.G7.35.H	151041	---	540	92

FV63V-4D



50Hz Motor	U	I	P ₂	n	
	V	A	kW	min ⁻¹	
30°	90 S	400	2,53	1,1	1430
35°	90 L	400	3,31	1,5	1430
40°	90 L	400	3,31	1,5	1430
45°	100 L	400	4,65	2,2	1440
50°	100 L	400	6,18	3	1440

Standard Temperature Range : -30°C / +50°C

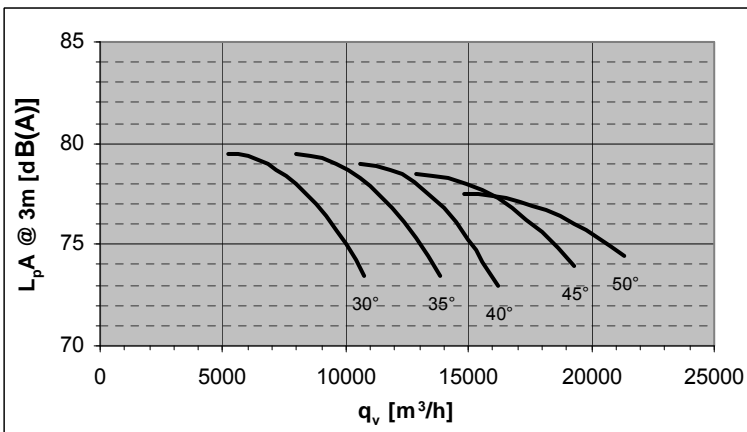
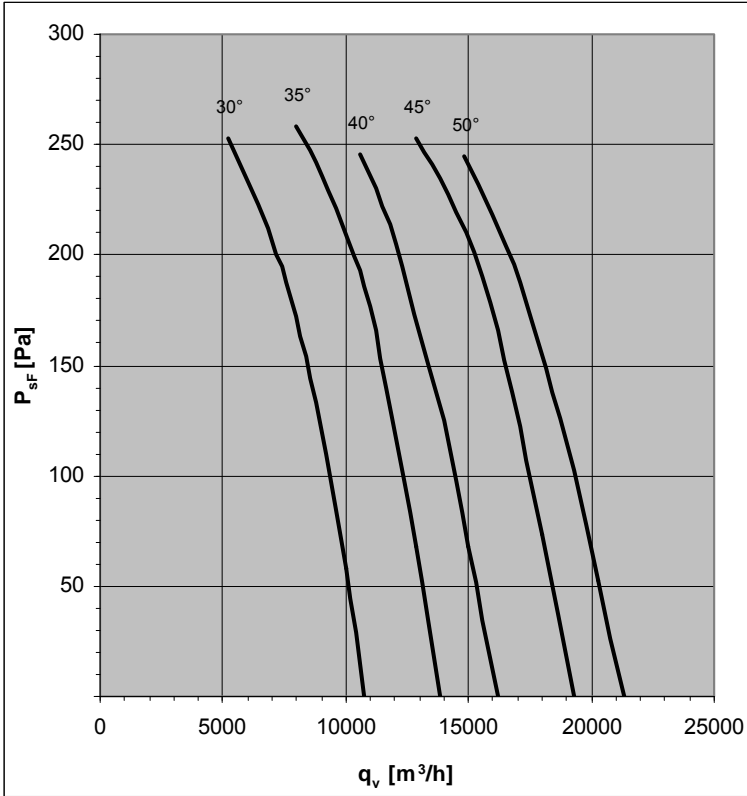

Design K

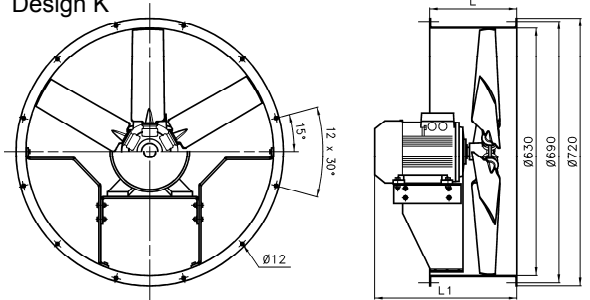

Design F

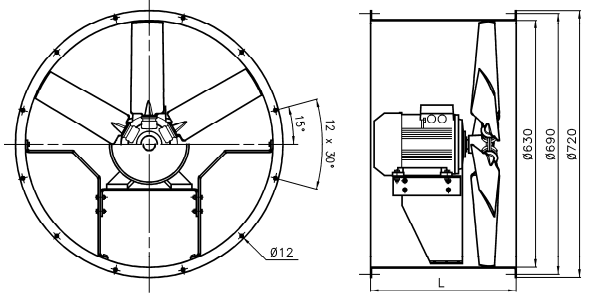

Pitch Angle	Relative spectrum LW dB(A)							
	63	125	250	500	1000	2000	4000	8000
30°	-46	-36	-16	-8	-4	-6	-12	-22
35°	-44	-35	-16	-8	-4	-6	-11	-21
40°	-43	-34	-16	-8	-4	-6	-10	-20
45°	-42	-33	-16	-8	-4	-6	-10	-19
50°	-41	-32	-17	-8	-4	-5	-9	-18

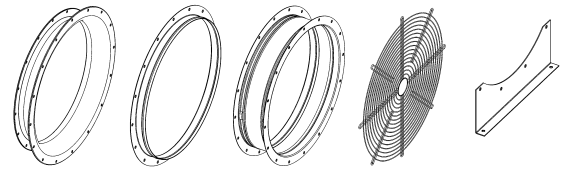

Accessories : see pages 104-106

Design	Pitch Angle	Type (G finish)	Part N°	Type (H finish)	Part N°	L1(mm)	L(mm)	Weight (kg)
K	30°	FV63V-4DK.C7.30.G	150393	FV63V-4DK.C7.30.H	150394	377	260	41
	35°	FV63V-4DK.D7.35.G	150397	FV63V-4DK.D7.35.H	150398	402	260	43
	40°	FV63V-4DK.D7.40.G	150401	FV63V-4DK.D7.40.H	150402	402	260	43
	45°	FV63V-4DK.E7.45.G	150405	FV63V-4DK.E7.45.H	150406	449	260	53
	50°	FV63V-4DK.E7.50.G	150409	FV63V-4DK.E7.50.H	150410	449	260	59
F	30°	FV63V-4DF.C7.30.G	150395	FV63V-4DF.C7.30.H	150396	---	470	48
	35°	FV63V-4DF.D7.35.G	150399	FV63V-4DF.D7.35.H	150400	---	470	51
	40°	FV63V-4DF.D7.40.G	150403	FV63V-4DF.D7.40.H	150404	---	470	51
	45°	FV63V-4DF.E7.45.G	150407	FV63V-4DF.E7.45.H	150408	---	470	61
	50°	FV63V-4DF.E7.50.G	150411	FV63V-4DF.E7.50.H	150412	---	470	67

FV63V-6D



50Hz Motor	U	I	P ₂	n	
	V	A	kW	min ⁻¹	
30°	71 M	400	0,79	0,25*	830
35°	80 M	400	1,2	0,37*	920
40°	80 M	400	1,6	0,55*	910
45°	80 M	400	1,6	0,55*	910
50°	90 S	400	1,98	0,75	920

*out of IE2 standard scope

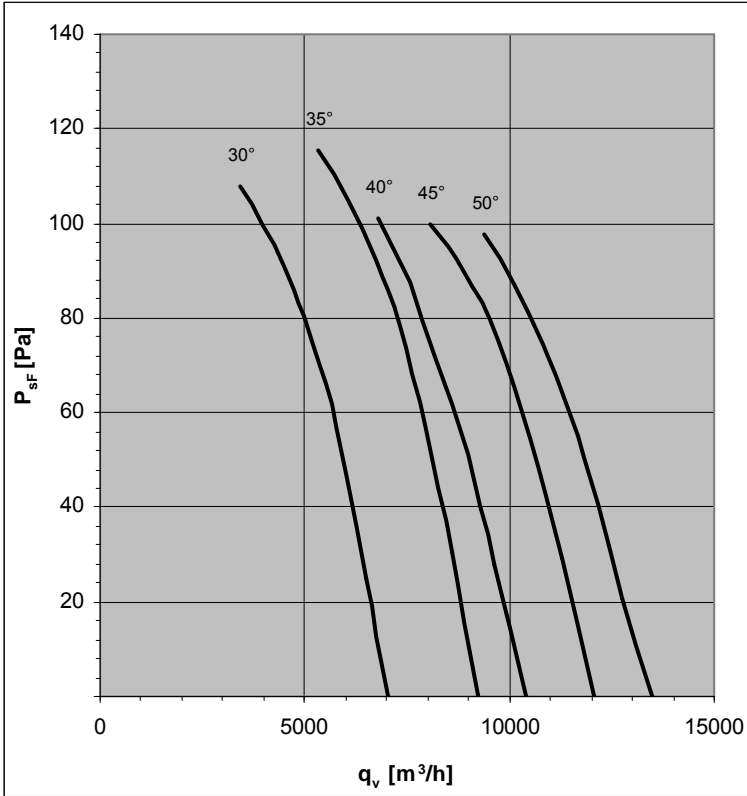

Design K

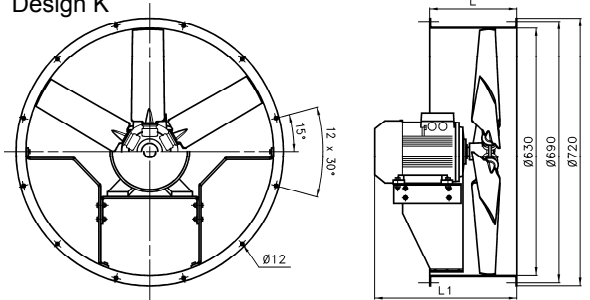

Design F

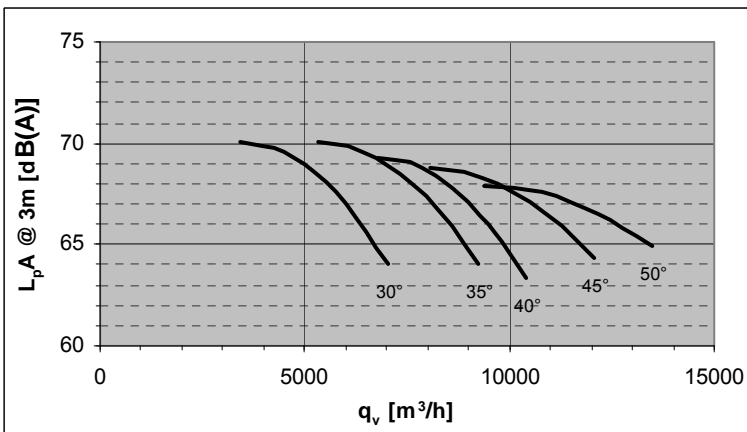
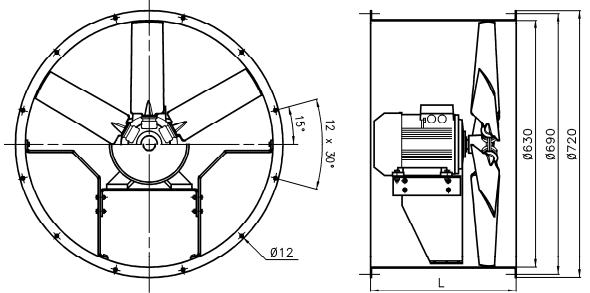

Pitch Angle	Relative spectrum LW dB(A)							
	63	125	250	500	1000	2000	4000	8000
30°	-41	-32	-14	-7	-4	-6	-10	-20
35°	-40	-31	-14	-7	-4	-5	-10	-19
40°	-38	-30	-14	-7	-4	-5	-9	-17
45°	-38	-29	-15	-7	-4	-5	-9	-17
50°	-37	-29	-15	-7	-4	-5	-8	-16

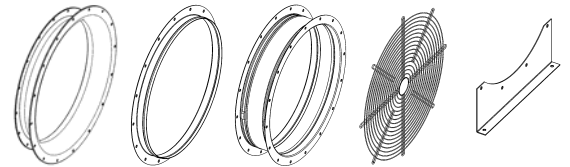

Accessories : see pages 104-106

Design	Pitch Angle	Type (G finish)	Part N°	Type (H finish)	Part N°	L1(mm)	L(mm)	Weight (kg)
K	30°	FV63V-6DK.A7.30.G	150413	FV63V-6DK.A7.30.H	150414	309	260	29
	35°	FV63V-6DK.B7.35.G	150417	FV63V-6DK.B7.35.H	150418	343	260	31
	40°	FV63V-6DK.B7.40.G	150421	FV63V-6DK.B7.40.H	150422	343	260	32
	45°	FV63V-6DK.B7.45.G	150425	FV63V-6DK.B7.45.H	150426	343	260	32
	50°	FV63V-6DK.C7.50.G	150429	FV63V-6DK.C7.50.H	150430	377	260	41
F	30°	FV63V-6DF.A7.30.G	150415	FV63V-6DF.A7.30.H	150416	---	470	36
	35°	FV63V-6DF.B7.35.G	150419	FV63V-6DF.B7.35.H	150420	---	470	39
	40°	FV63V-6DF.B7.40.G	150423	FV63V-6DF.B7.40.H	150424	---	470	40
	45°	FV63V-6DF.B7.45.G	150427	FV63V-6DF.B7.45.H	150428	---	470	40
	50°	FV63V-6DF.C7.50.G	150431	FV63V-6DF.C7.50.H	150432	---	470	48

FV63V-8D



50Hz Motor	U	I	P ₂	n	
	V	A	kW	min ⁻¹	
30°	71 M	400	0,36	0,09*	630
35°	71 M	400	0,51	0,12*	645
40°	80 M	400	0,75	0,18*	675
45°	80 M	400	1,02	0,25*	685
50°	80 M	400	1,02	0,25*	685

*out of IE2 standard scope

Standard Temperature Range : -30°C / +50°C

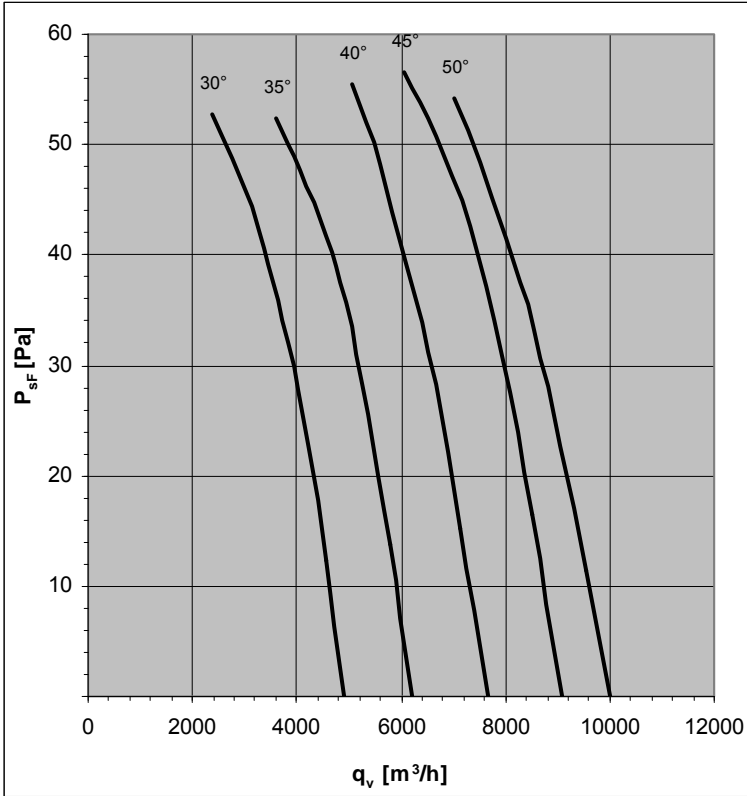

Design K

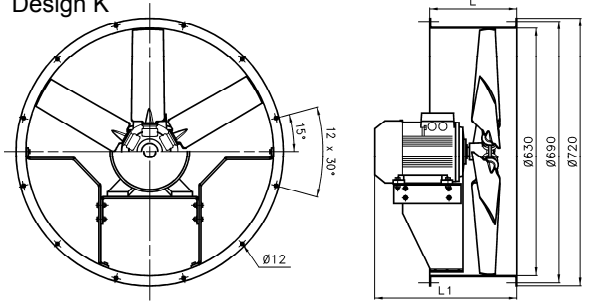

Design F

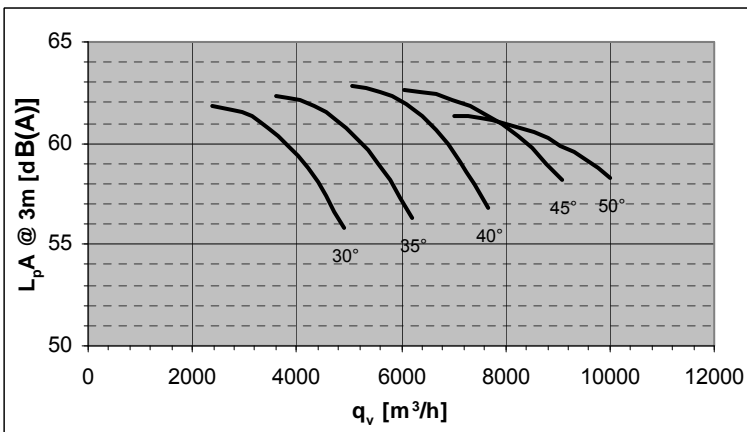
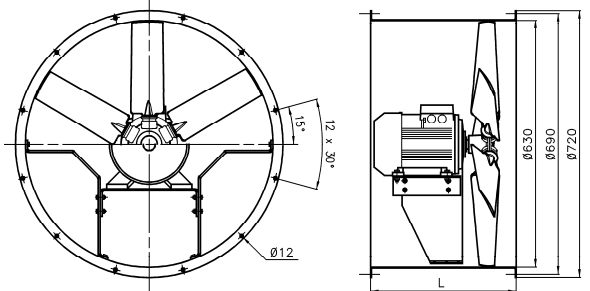

Pitch Angle	Relative spectrum LW dB(A)							
	63	125	250	500	1000	2000	4000	8000
30°	-37	-29	-13	-6	-3	-5	-9	-18
35°	-36	-28	-13	-6	-3	-5	-9	-17
40°	-35	-28	-13	-6	-3	-5	-8	-16
45°	-35	-27	-13	-7	-3	-5	-8	-15
50°	-34	-26	-14	-7	-3	-4	-7	-14

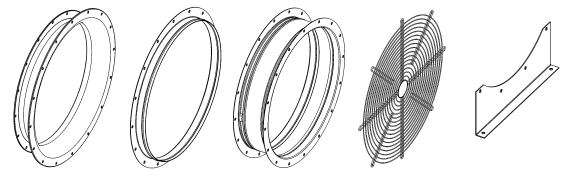

Accessories : see pages 104-106

Design	Pitch Angle	Type (G finish)	Part N°	Type (H finish)	Part N°	L1(mm)	L(mm)	Weight (kg)
K	30°	FV63V-8DK.A7.30.G	150433	FV63V-8DK.A7.30.H	150434	309	260	29
	35°	FV63V-8DK.A7.35.G	150437	FV63V-8DK.A7.35.H	150438	309	260	29
	40°	FV63V-8DK.B7.40.G	150441	FV63V-8DK.B7.40.H	150442	343	260	31
	45°	FV63V-8DK.B7.45.G	150445	FV63V-8DK.B7.45.H	150446	343	260	32
	50°	FV63V-8DK.B7.50.G	150449	FV63V-8DK.B7.50.H	150450	343	260	32
F	30°	FV63V-8DF.A7.30.G	150435	FV63V-8DF.A7.30.H	150436	---	470	36
	35°	FV63V-8DF.A7.35.G	150439	FV63V-8DF.A7.35.H	150440	---	470	36
	40°	FV63V-8DF.B7.40.G	150443	FV63V-8DF.B7.40.H	150444	---	470	39
	45°	FV63V-8DF.B7.45.G	150447	FV63V-8DF.B7.45.H	150448	---	470	40
	50°	FV63V-8DF.B7.50.G	150451	FV63V-8DF.B7.50.H	150452	---	470	40

FV71V-4D



50Hz Motor	U	I	P ₂	n	
	V	A	kW	min ⁻¹	
25°	90 L	400	3,31	1,5	1430
30°	100 L	400	4,65	2,2	1440
35°	100 L	400	6,18	3	1440
40°	112 M	400	8,13	4	1450
45°	112 M	400	8,13	4	1450

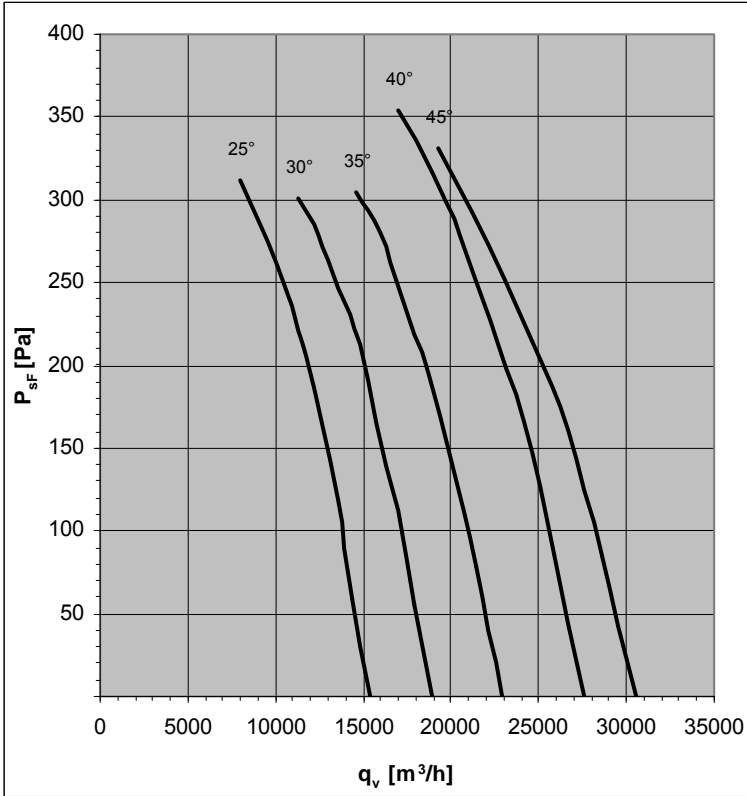

Design K

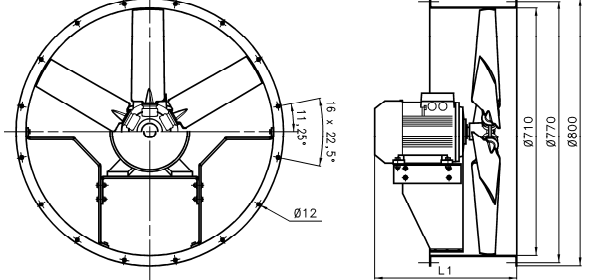

Design F

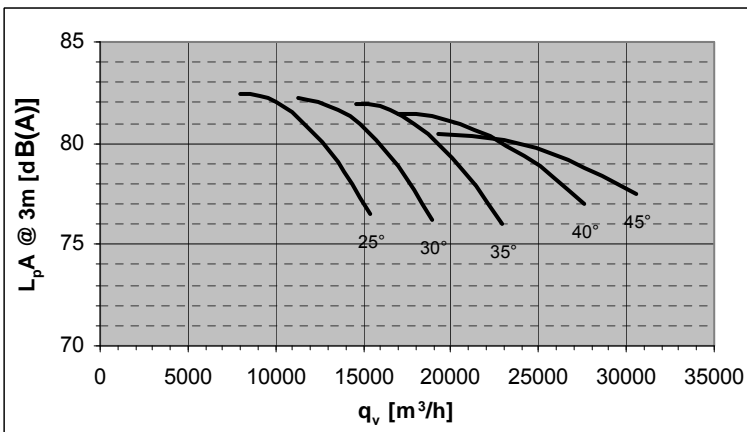
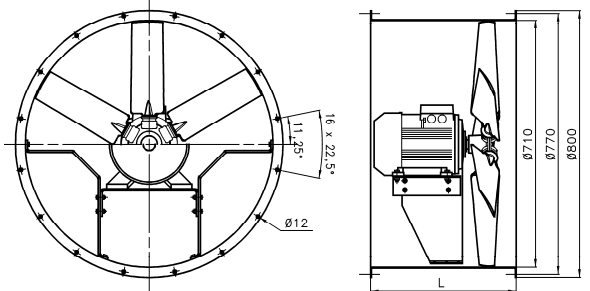

Pitch Angle	Relative spectrum LW dB(A)							
	63	125	250	500	1000	2000	4000	8000
25°	-47	-37	-16	-8	-4	-6	-12	-23
30°	-46	-36	-16	-8	-4	-6	-11	-21
35°	-44	-35	-17	-8	-4	-6	-10	-20
40°	-44	-34	-17	-8	-4	-6	-10	-19
45°	-43	-33	-17	-8	-4	-6	-9	-18

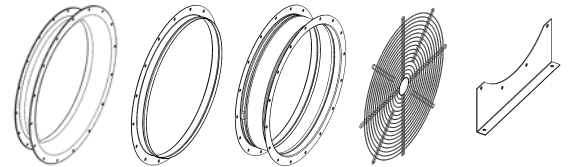

Accessories : see pages 104-106

Design	Pitch Angle	Type (G finish)	Part N°	Type (H finish)	Part N°	L1(mm)	L(mm)	Weight (kg)
K	25°	FV71V-4DK.D7.25.G	150465	FV71V-4DK.D7.25.H	150466	424	280	48
	30°	FV71V-4DK.E7.30.G	150469	FV71V-4DK.E7.30.H	150470	471	280	58
	35°	FV71V-4DK.E7.35.G	150473	FV71V-4DK.E7.35.H	150474	471	280	64
	40°	FV71V-4DK.F7.40.G	150477	FV71V-4DK.F7.40.H	150478	488	400	79
	45°	FV71V-4DK.F7.45.G	150481	FV71V-4DK.F7.45.H	150482	488	400	79
F	25°	FV71V-4DF.D7.25.G	150467	FV71V-4DF.D7.25.H	150468	---	500	58
	30°	FV71V-4DF.E7.30.G	150471	FV71V-4DF.E7.30.H	150472	---	500	68
	35°	FV71V-4DF.E7.35.G	150475	FV71V-4DF.E7.35.H	150476	---	500	74
	40°	FV71V-4DF.F7.40.G	150479	FV71V-4DF.F7.40.H	150480	---	560	86
	45°	FV71V-4DF.F7.45.G	150483	FV71V-4DF.F7.45.H	150484	---	560	86

FV71V-6D



50Hz Motor	U	I	P ₂	n	
	V	A	kW	min ⁻¹	
25°	80 M	400	1,2	0,37*	920
30°	80 M	400	1,6	0,55*	910
35°	90 S	400	1,98	0,75	920
40°	90 L	400	2,78	1,1	920
45°	90 L	400	2,78	1,1	920

*out of IE2 standard scope

Standard Temperature Range : -30°C / +50°C

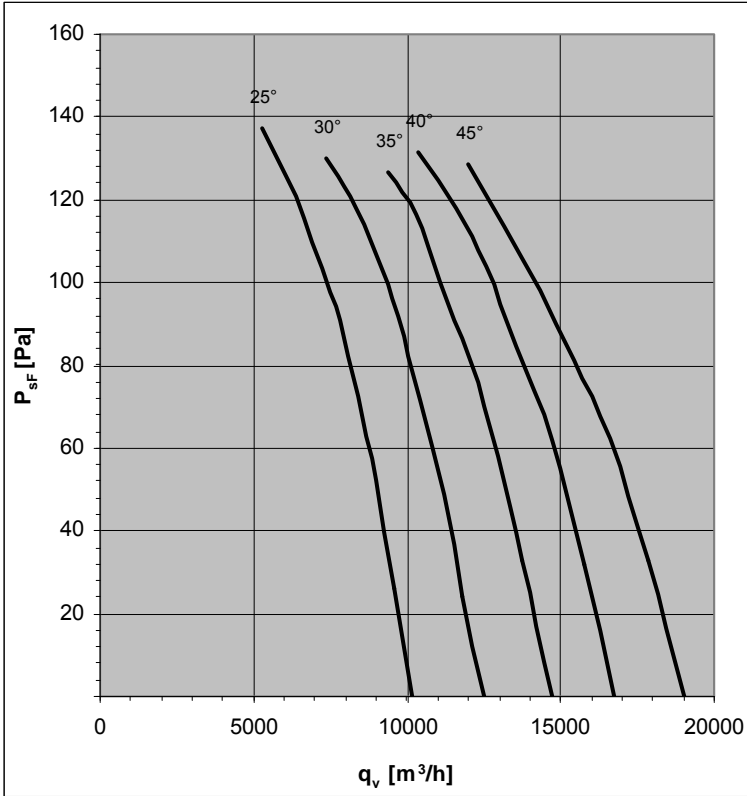

Design K

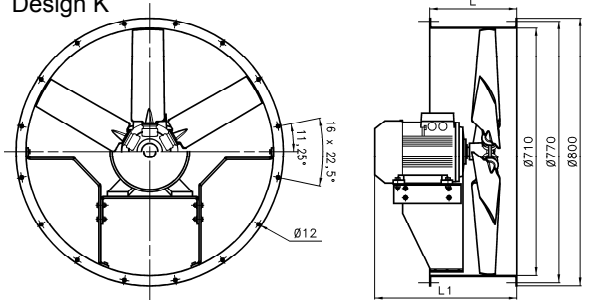

Design F

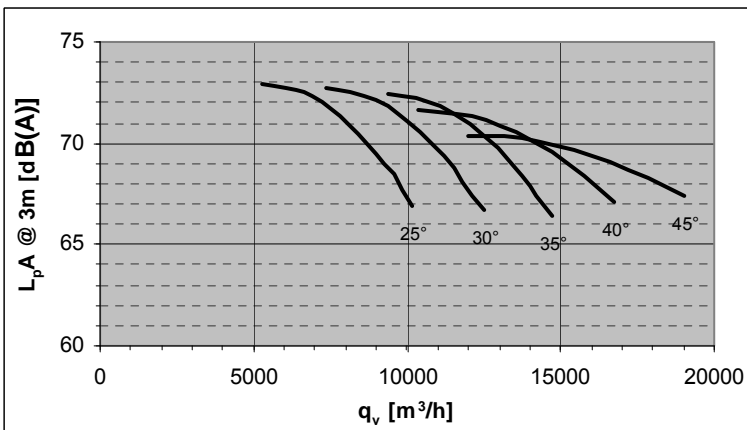
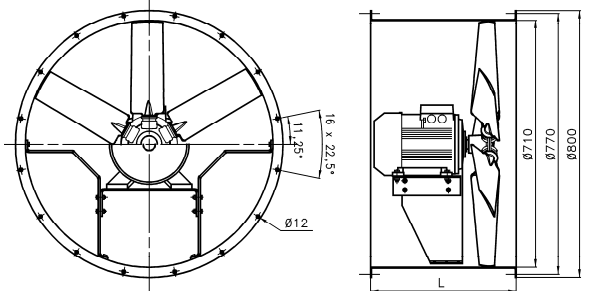

Pitch Angle	Relative spectrum LW dB(A)							
	63	125	250	500	1000	2000	4000	8000
25°	-42	-33	-15	-7	-4	-6	-11	-20
30°	-41	-32	-15	-7	-4	-6	-10	-19
35°	-40	-31	-15	-7	-4	-5	-9	-18
40°	-39	-30	-15	-7	-4	-5	-9	-17
45°	-38	-30	-15	-7	-4	-5	-8	-16

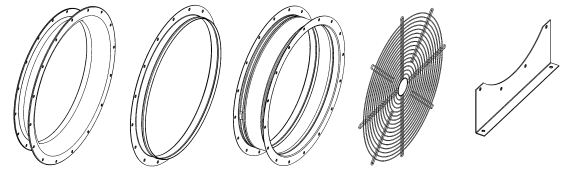

Accessories : see pages 104-106

Design	Pitch Angle	Type (G finish)	Part N°	Type (H finish)	Part N°	L1(mm)	L(mm)	Weight (kg)
K	25°	FV71V-6DK.B7.25.G	150485	FV71V-6DK.B7.25.H	150486	365	280	36
	30°	FV71V-6DK.B7.30.G	150489	FV71V-6DK.B7.30.H	150490	365	280	37
	35°	FV71V-6DK.C7.35.G	150493	FV71V-6DK.C7.35.H	150494	399	280	46
	40°	FV71V-6DK.D7.40.G	150497	FV71V-6DK.D7.40.H	150498	424	280	48
	45°	FV71V-6DK.D7.45.G	150501	FV71V-6DK.D7.45.H	150502	424	280	48
F	25°	FV71V-6DF.B7.25.G	150487	FV71V-6DF.B7.25.H	150488	---	500	46
	30°	FV71V-6DF.B7.30.G	150491	FV71V-6DF.B7.30.H	150492	---	500	47
	35°	FV71V-6DF.C7.35.G	150495	FV71V-6DF.C7.35.H	150496	---	500	55
	40°	FV71V-6DF.D7.40.G	150499	FV71V-6DF.D7.40.H	150500	---	500	58
	45°	FV71V-6DF.D7.45.G	150503	FV71V-6DF.D7.45.H	150504	---	500	58

FV71V-8D



50Hz Motor	U	I	P ₂	n	
	V	A	kW	min ⁻¹	
25°	80 M	400	0,75	0,18*	675
30°	80 M	400	1,02	0,25*	685
35°	90 S	400	1,14	0,37*	675
40°	90 S	400	1,14	0,37*	675
45°	90 L	400	1,58	0,55*	675

*out of IE2 standard scope

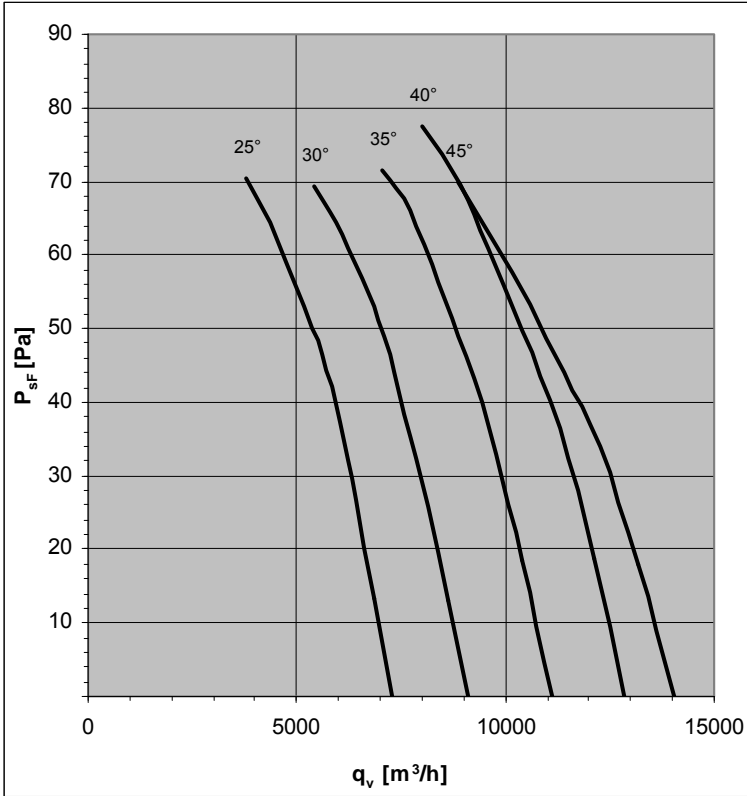

Design K

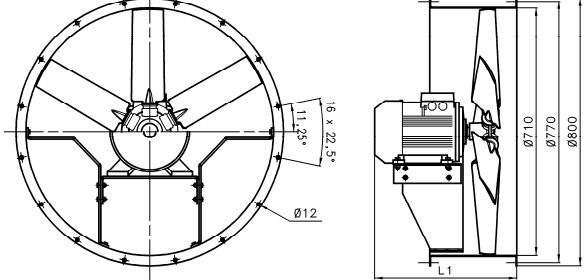

Design F

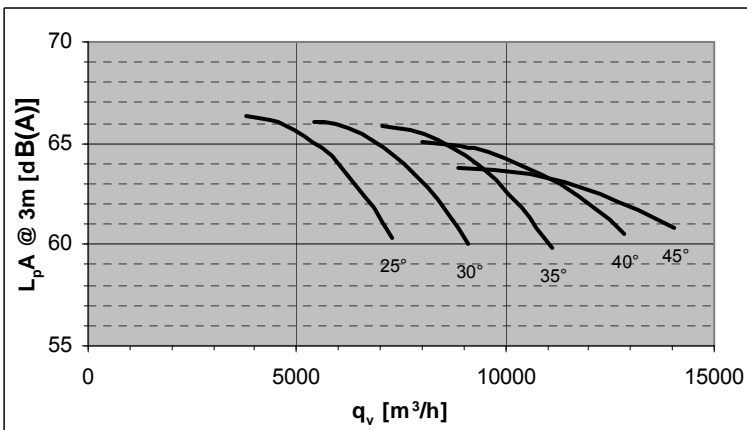
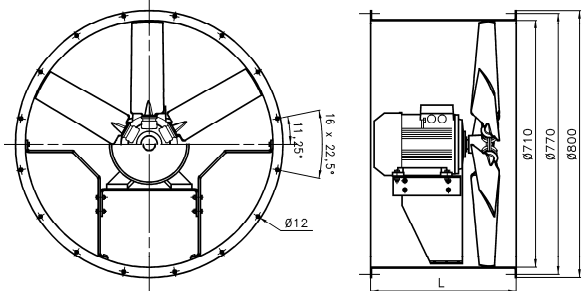

Pitch Angle	Relative spectrum LW dB(A)							
	63	125	250	500	1000	2000	4000	8000
25°	-39	-31	-13	-7	-4	-5	-10	-19
30°	-38	-30	-14	-7	-4	-5	-9	-18
35°	-37	-29	-14	-7	-4	-5	-9	-17
40°	-36	-28	-14	-7	-4	-5	-8	-16
45°	-35	-27	-14	-7	-4	-5	-8	-15

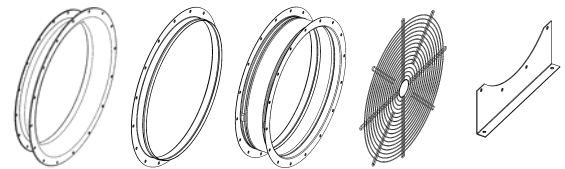

Accessories : see pages 104-106

Design	Pitch Angle	Type (G finish)	Part N°	Type (H finish)	Part N°	L1(mm)	L(mm)	Weight (kg)
K	25°	FV71V-8DK.B7.25.G	150505	FV71V-8DK.B7.25.H	150506	365	280	36
	30°	FV71V-8DK.B7.30.G	150509	FV71V-8DK.B7.30.H	150510	365	280	37
	35°	FV71V-8DK.C7.35.G	150513	FV71V-8DK.C7.35.H	150514	420	280	38
	40°	FV71V-8DK.C7.40.G	150517	FV71V-8DK.C7.40.H	150518	420	280	38
	45°	FV71V-8DK.D7.45.G	150521	FV71V-8DK.D7.45.H	150522	420	280	40
F	25°	FV71V-8DF.B7.25.G	150507	FV71V-8DF.B7.25.H	150508	---	500	46
	30°	FV71V-8DF.B7.30.G	150511	FV71V-8DF.B7.30.H	150512	---	500	47
	35°	FV71V-8DF.C7.35.G	150515	FV71V-8DF.C7.35.H	150516	---	500	47
	40°	FV71V-8DF.C7.40.G	150519	FV71V-8DF.C7.40.H	150520	---	500	47
	45°	FV71V-8DF.D7.45.G	150523	FV71V-8DF.D7.45.H	150524	---	500	50

FV80V-4D



50Hz Motor	U	I	P ₂	n	
	V	A	kW	min ⁻¹	
25°	100 L	400	4,65	2,2	1440
30°	100 L	400	6,18	3	1440
35°	112 M	400	8,13	4	1450
40°	132 S	400	10,9	5,5	1460
45°	132 M	400	14,5	7,5	1460

Standard Temperature Range : -30°C / +50°C

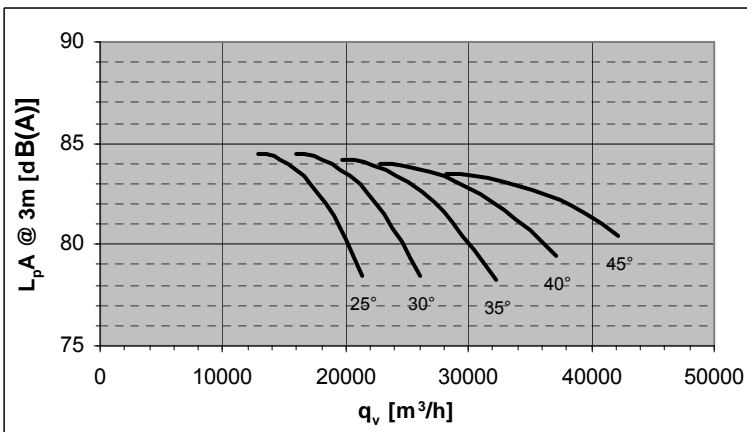
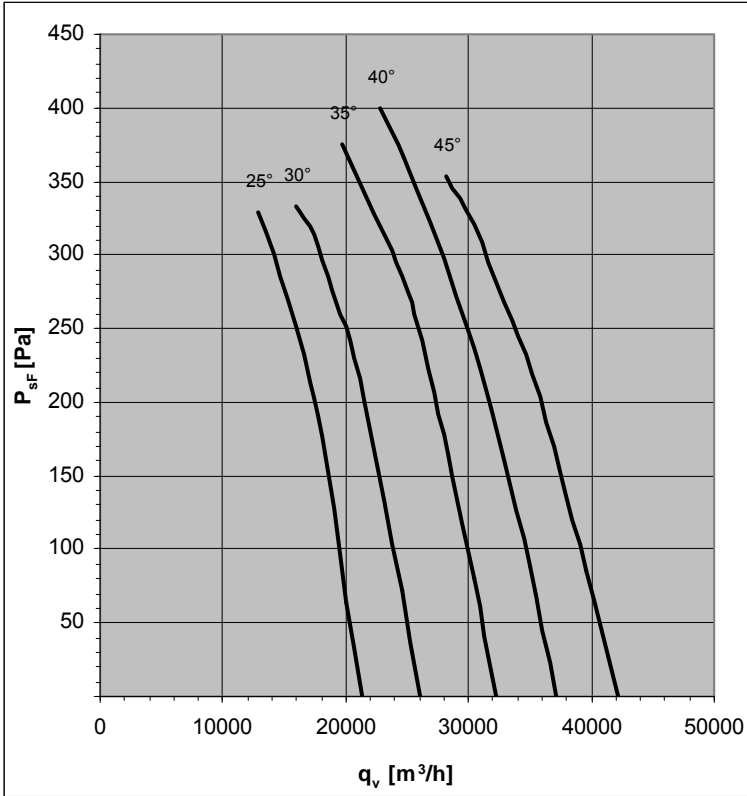

Design K

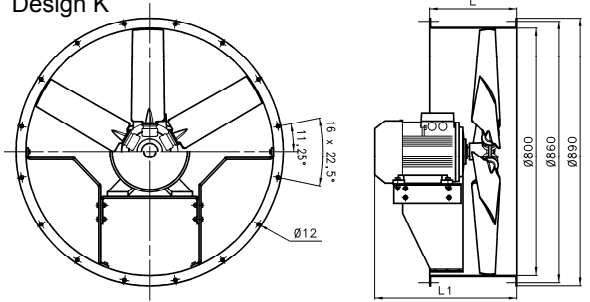

Design F

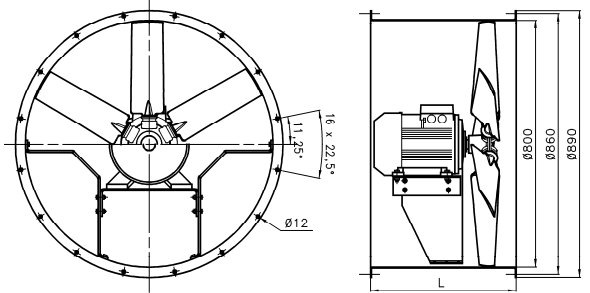

Pitch Angle	Relative spectrum LW dB(A)							
	63	125	250	500	1000	2000	4000	8000
25°	-48	-38	-17	-8	-4	-7	-12	-23
30°	-47	-37	-17	-8	-4	-6	-12	-22
35°	-45	-36	-17	-8	-4	-6	-11	-21
40°	-45	-35	-17	-8	-4	-6	-10	-20
45°	-44	-34	-18	-9	-4	-6	-9	-19

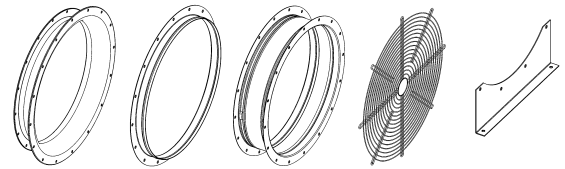

Accessories : see pages 104-106

Design	Pitch Angle	Type (G finish)	Part N°	Type (H finish)	Part N°	L1(mm)	L(mm)	Weight (kg)
K	25°	FV80V-4DK.E7.25.G	150533	FV80V-4DK.E7.25.H	150534	471	280	66
	30°	FV80V-4DK.E7.30.G	150537	FV80V-4DK.E7.30.H	150538	471	280	72
	35°	FV80V-4DK.F7.35.G	150541	FV80V-4DK.F7.35.H	150542	488	400	89
	40°	FV80V-4DK.G7.40.G	150545	FV80V-4DK.G7.40.H	150546	562	400	99
	45°	FV80V-4DK.H7.45.G	150549	FV80V-4DK.H7.45.H	150550	562	400	111
F	25°	FV80V-4DF.E7.25.G	150535	FV80V-4DF.E7.25.H	150536	---	500	78
	30°	FV80V-4DF.E7.30.G	150539	FV80V-4DF.E7.30.H	150540	---	500	84
	35°	FV80V-4DF.F7.35.G	150543	FV80V-4DF.F7.35.H	150544	---	540	95
	40°	FV80V-4DF.G7.40.G	150547	FV80V-4DF.G7.40.H	150548	---	700	117
	45°	FV80V-4DF.H7.45.G	150551	FV80V-4DF.H7.45.H	150552	---	700	128

FV80V-6D



50Hz Motor	U	I	P ₂	n	
	V	A	kW	min ⁻¹	
25°	80 M	400	1,6	0,55*	910
30°	90 S	400	1,98	0,75	920
35°	90 L	400	2,78	1,1	920
40°	100 L	400	3,62	1,5	940
45°	112 M	400	5,11	2,2	960

*out of IE2 standard scope

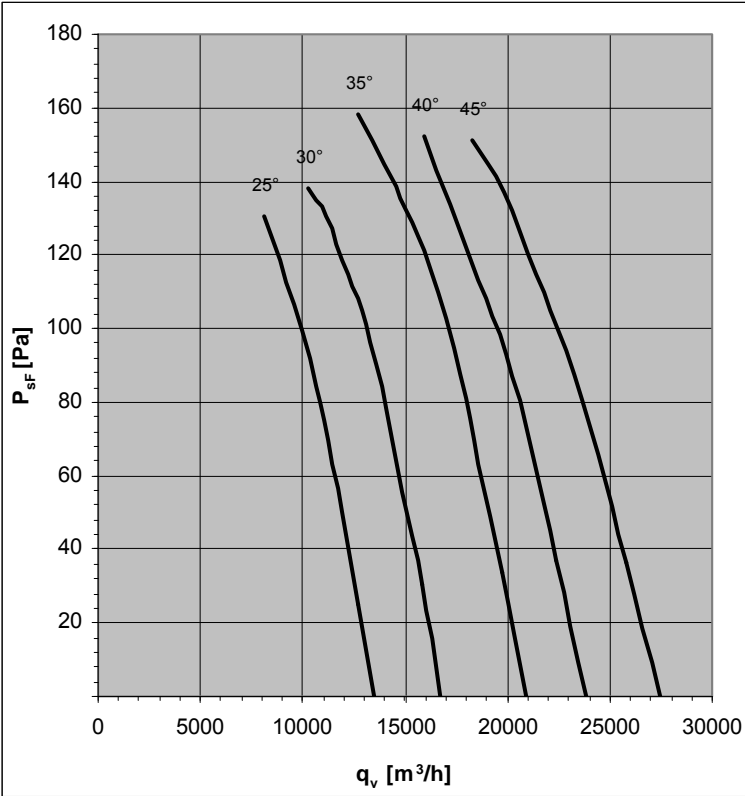

Design K

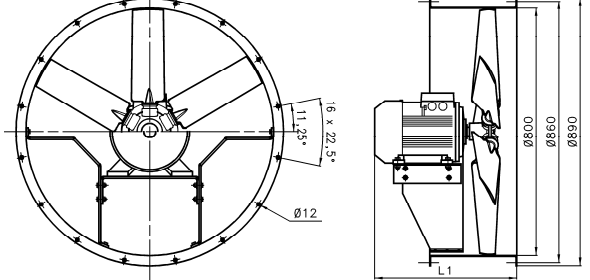

Design F

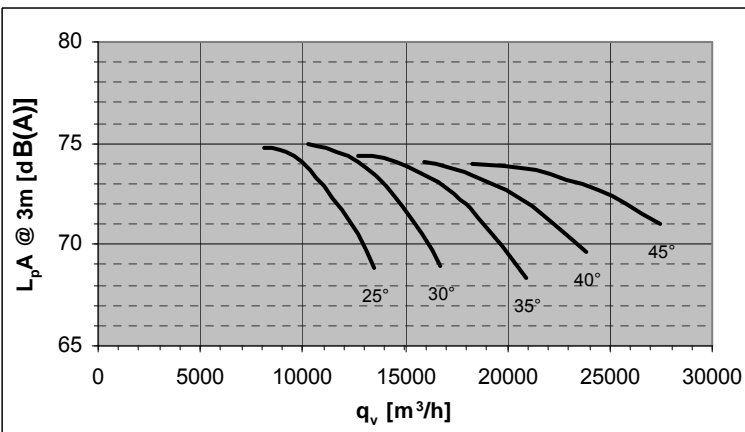
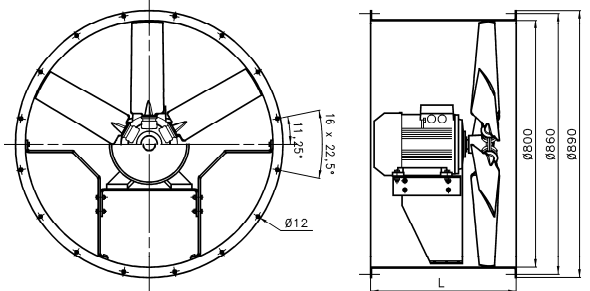

Pitch Angle	Relative spectrum LW dB(A)							
	63	125	250	500	1000	2000	4000	8000
25°	-43	-34	-15	-7	-4	-6	-11	-21
30°	-42	-33	-15	-7	-4	-6	-10	-20
35°	-41	-32	-15	-7	-4	-5	-10	-19
40°	-40	-31	-16	-8	-4	-5	-9	-18
45°	-40	-31	-16	-8	-4	-5	-9	-17

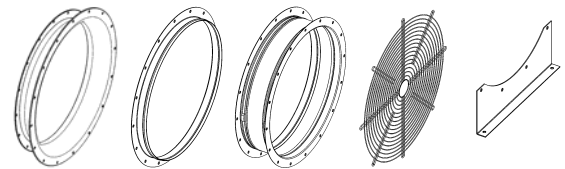

Accessories : see pages 104-106

Design	Pitch Angle	Type (G finish)	Part N°	Type (H finish)	Part N°	L1(mm)	L(mm)	Weight (kg)
K	25°	FV80V-6DK.B7.25.G	150553	FV80V-6DK.B7.25.H	150554	365	280	45
	30°	FV80V-6DK.C7.30.G	150557	FV80V-6DK.C7.30.H	150558	399	280	53
	35°	FV80V-6DK.D7.35.G	150561	FV80V-6DK.D7.35.H	150562	424	280	56
	40°	FV80V-6DK.E7.40.G	150565	FV80V-6DK.E7.40.H	150566	471	280	63
	45°	FV80V-6DK.F7.45.G	150569	FV80V-6DK.F7.45.H	150570	488	400	80
F	25°	FV80V-6DF.B7.25.G	150555	FV80V-6DF.B7.25.H	150556	---	500	57
	30°	FV80V-6DF.C7.30.G	150559	FV80V-6DF.C7.30.H	150560	---	500	66
	35°	FV80V-6DF.D7.35.G	150563	FV80V-6DF.D7.35.H	150564	---	500	68
	40°	FV80V-6DF.E7.40.G	150567	FV80V-6DF.E7.40.H	150568	---	500	76
	45°	FV80V-6DF.F7.45.G	150571	FV80V-6DF.F7.45.H	150572	---	540	86

FV80V-8D



50Hz Motor	U	I	P ₂	n	
	V	A	kW	min ⁻¹	
25°	80 M	400	1,02	0,25*	685
30°	90 S	400	1,14	0,37*	675
35°	90 L	400	1,58	0,55*	675
40°	90 L	400	1,58	0,55*	675
45°	100 L	400	2,8	0,75*	725

*out of IE2 standard scope

Standard Temperature Range : -30°C / +50°C

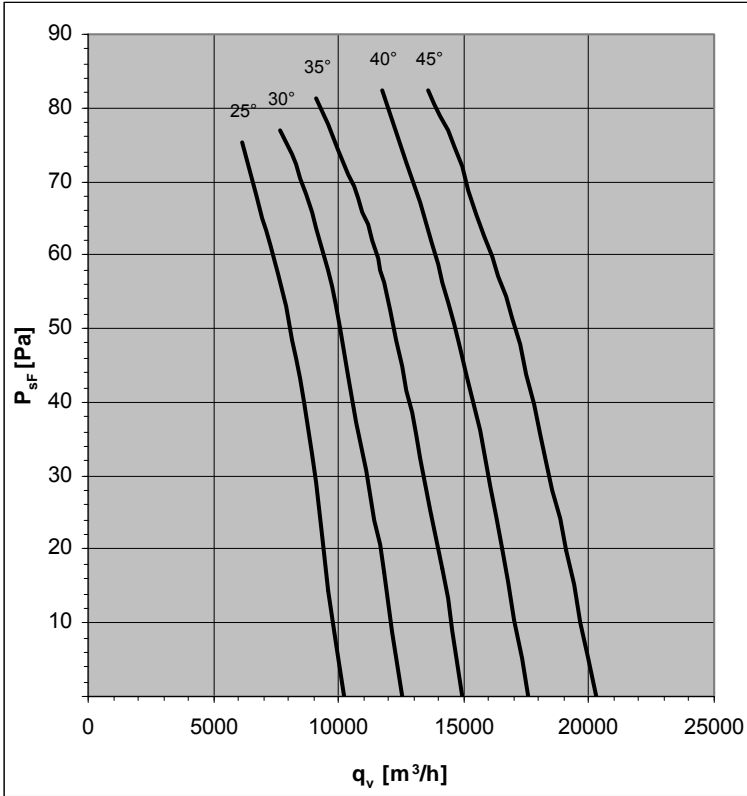

Design K

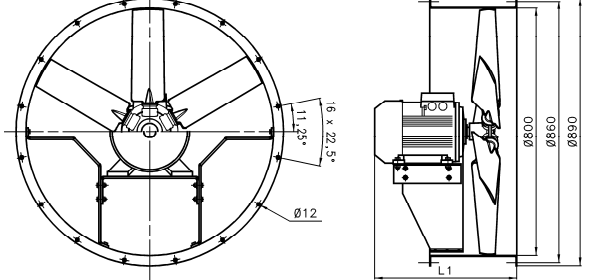

Design F

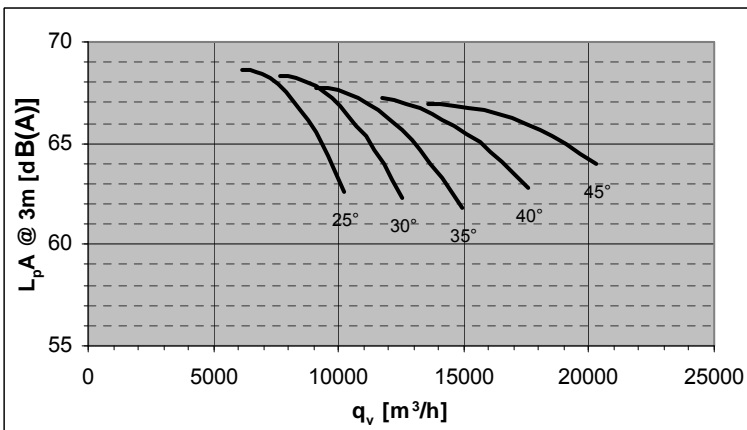
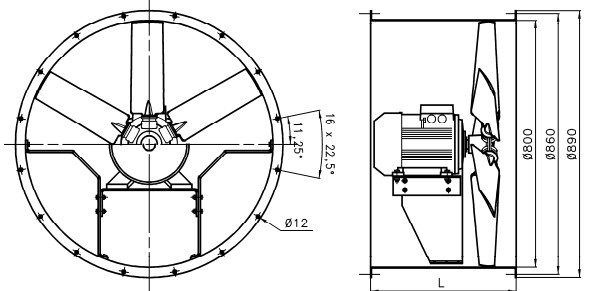

Pitch Angle	Relative spectrum LW dB(A)							
	63	125	250	500	1000	2000	4000	8000
25°	-40	-32	-14	-7	-4	-5	-10	-19
30°	-39	-31	-14	-7	-4	-5	-10	-18
35°	-38	-29	-14	-7	-4	-5	-9	-17
40°	-37	-29	-14	-7	-4	-5	-8	-16
45°	-37	-28	-15	-7	-4	-5	-8	-16

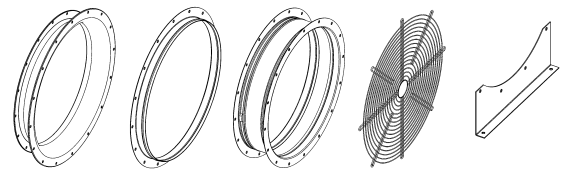

Accessories : see pages 104-106

Design	Pitch Angle	Type (G finish)	Part N°	Type (H finish)	Part N°	L1(mm)	L(mm)	Weight (kg)
K	25°	FV80V-8DK.B7.25.G	150573	FV80V-8DK.B7.25.H	150574	365	280	45
	30°	FV80V-8DK.C7.30.G	150577	FV80V-8DK.C7.30.H	150578	420	280	45
	35°	FV80V-8DK.D7.35.G	150581	FV80V-8DK.D7.35.H	150582	420	280	48
	40°	FV80V-8DK.D7.40.G	150585	FV80V-8DK.D7.40.H	150586	420	280	48
	45°	FV80V-8DK.E7.45.G	150589	FV80V-8DK.E7.45.H	150590	484	280	56
F	25°	FV80V-8DF.B7.25.G	150575	FV80V-8DF.B7.25.H	150576	---	500	57
	30°	FV80V-8DF.C7.30.G	150579	FV80V-8DF.C7.30.H	150580	---	500	58
	35°	FV80V-8DF.D7.35.G	150583	FV80V-8DF.D7.35.H	150584	---	500	61
	40°	FV80V-8DF.D7.40.G	150587	FV80V-8DF.D7.40.H	150588	---	500	61
	45°	FV80V-8DF.E7.45.G	150591	FV80V-8DF.E7.45.H	150592	---	500	68

FV90V-4D



50Hz Motor	U	I	P ₂	n	
	V	A	kW	min ⁻¹	
25°	100 L	400	6,18	3	1440
30°	112 M	400	8,13	4	1450
35°	132 S	400	10,9	5,5	1460
40°	132 M	400	14,5	7,5	1460
45°	160 M	400	21	11	1470

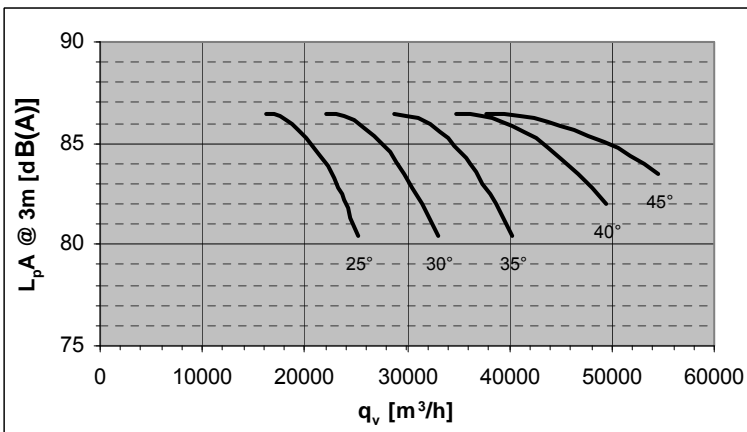
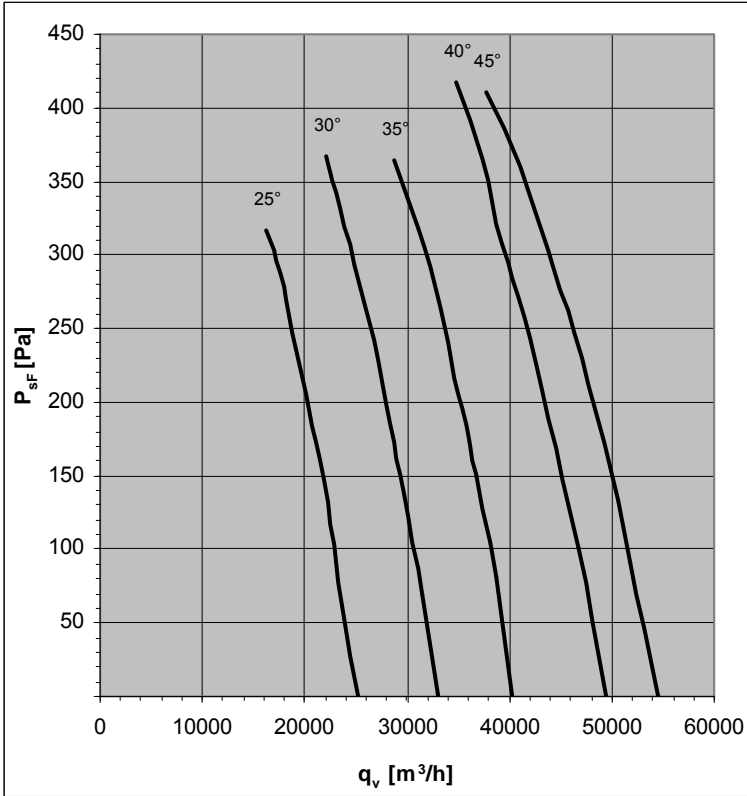

Design K

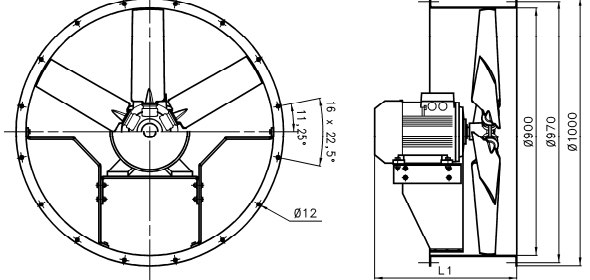

Design F

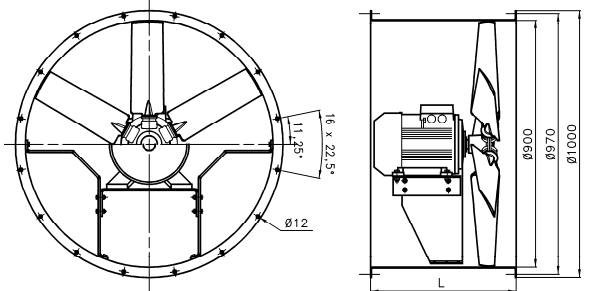

Pitch Angle	Relative spectrum LW dB(A)							
	63	125	250	500	1000	2000	4000	8000
25°	-49	-39	-17	-8	-5	-7	-13	-24
30°	-48	-38	-17	-8	-5	-6	-12	-22
35°	-47	-36	-17	-8	-5	-6	-11	-21
40°	-46	-36	-18	-9	-5	-6	-10	-20
45°	-45	-35	-18	-9	-5	-6	-10	-19

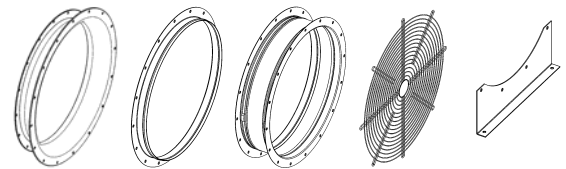

Accessories : see pages 104-106

Design	Pitch Angle	Type (G finish)	Part N°	Type (H finish)	Part N°	L1(mm)	L(mm)	Weight (kg)
K	25°	FV90V-4DK.E7.25.G	150613	FV90V-4DK.E7.25.H	150614	471	280	78
	30°	FV90V-4DK.F7.30.G	150617	FV90V-4DK.F7.30.H	150618	488	400	96
	35°	FV90V-4DK.G7.35.G	150621	FV90V-4DK.G7.35.H	150622	562	400	106
	40°	FV90V-4DK.H7.40.G	150625	FV90V-4DK.H7.40.H	150626	562	400	118
	45°	FV90V-4DK.I7.45.G	150629	FV90V-4DK.I7.45.H	150630	702	400	197
F	25°	FV90V-4DF.E7.25.G	150615	FV90V-4DF.E7.25.H	150616	---	500	92
	30°	FV90V-4DF.F7.30.G	150619	FV90V-4DF.F7.30.H	150620	---	540	102
	35°	FV90V-4DF.G7.35.G	150623	FV90V-4DF.G7.35.H	150624	---	700	124
	40°	FV90V-4DF.H7.40.G	150627	FV90V-4DF.H7.40.H	150628	---	700	136
	45°	FV90V-4DF.I7.45.G	150631	FV90V-4DF.I7.45.H	150632	---	700	216

FV90V-6D



50Hz Motor	U	I	P ₂	n	
	V	A	kW	min ⁻¹	
25°	90 S	400	1,98	0,75	920
30°	90 L	400	2,78	1,1	920
35°	100 L	400	3,62	1,5	940
40°	112 M	400	5,11	2,2	960
45°	132 S	400	6,84	3	960

Standard Temperature Range : -30°C / +50°C

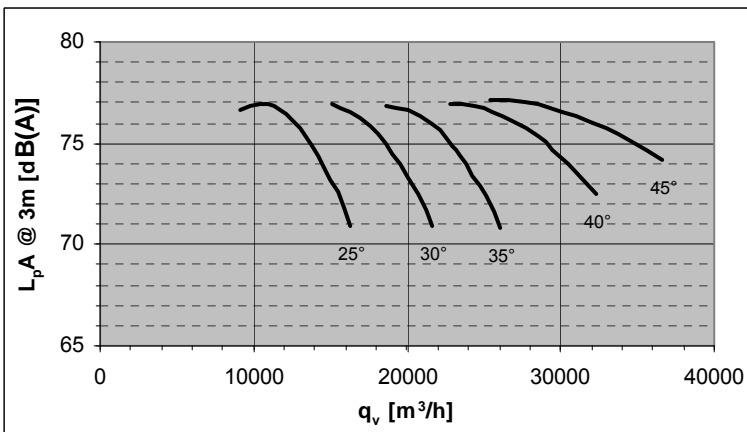
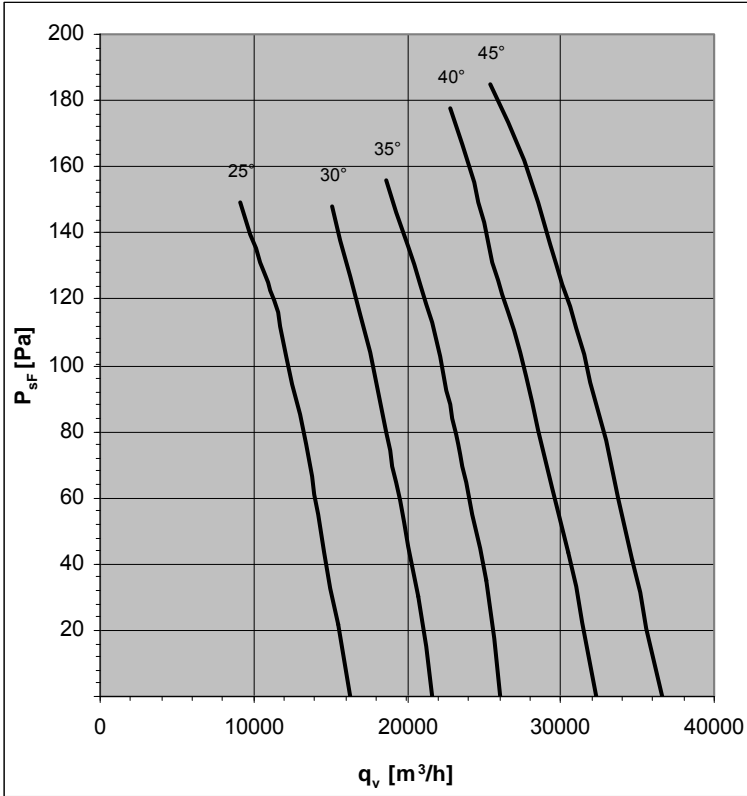

Design K

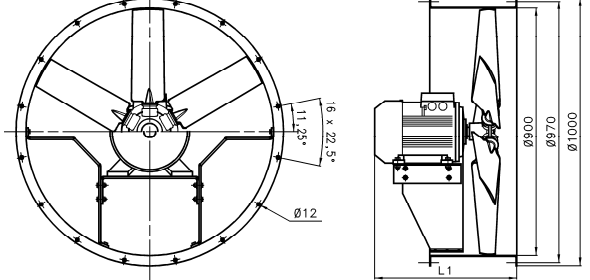

Design F

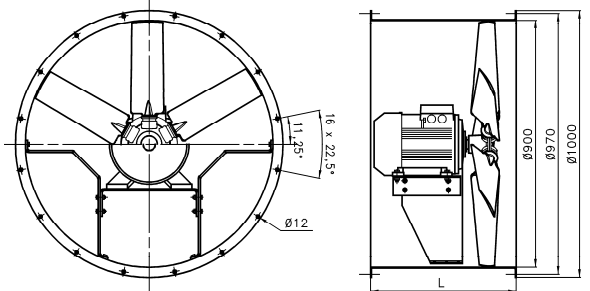

Pitch Angle	Relative spectrum LW dB(A)							
	63	125	250	500	1000	2000	4000	8000
25°	-44	-35	-15	-8	-4	-6	-11	-21
30°	-43	-34	-15	-8	-4	-6	-11	-20
35°	-42	-33	-16	-8	-4	-6	-10	-19
40°	-42	-32	-16	-8	-4	-6	-9	-18
45°	-41	-32	-16	-8	-4	-5	-9	-18

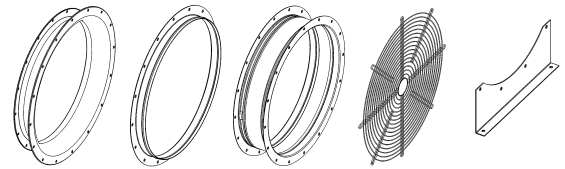

Accessories : see pages 104-106

Design	Pitch Angle	Type (G finish)	Part N°	Type (H finish)	Part N°	L1(mm)	L(mm)	Weight (kg)
K	25°	FV90V-6DK.C7.25.G	150633	FV90V-6DK.C7.25.H	150634	399	280	59
	30°	FV90V-6DK.D7.30.G	150637	FV90V-6DK.D7.30.H	150638	424	280	62
	35°	FV90V-6DK.E7.35.G	150641	FV90V-6DK.E7.35.H	150642	471	280	69
	40°	FV90V-6DK.F7.40.G	150645	FV90V-6DK.F7.40.H	150646	488	400	87
	45°	FV90V-6DK.G7.45.G	150649	FV90V-6DK.G7.45.H	150650	562	400	98
F	25°	FV90V-6DF.C7.25.G	150635	FV90V-6DF.C7.25.H	150636	---	500	74
	30°	FV90V-6DF.D7.30.G	150639	FV90V-6DF.D7.30.H	150640	---	500	76
	35°	FV90V-6DF.E7.35.G	150643	FV90V-6DF.E7.35.H	150644	---	500	84
	40°	FV90V-6DF.F7.40.G	150647	FV90V-6DF.F7.40.H	150648	---	540	94
	45°	FV90V-6DF.G7.45.G	150651	FV90V-6DF.G7.45.H	150652	---	700	116

FV90V-8D



50Hz Motor	U	I	P ₂	n	
	V	A	kW	min ⁻¹	
25°	90 S	400	1,14	0,37*	675
30°	90 L	400	1,58	0,55*	675
35°	100 L	400	2,8	0,75*	725
40°	100 L	400	2,8	0,75*	725
45°	100 L	400	4,1	1,1*	725

*out of IE2 standard scope

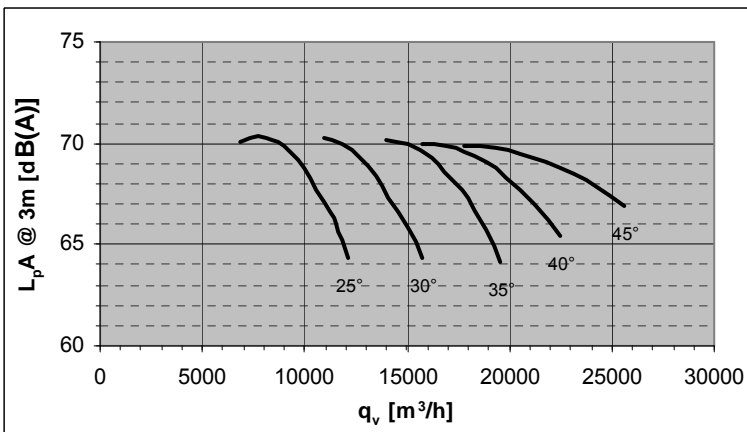
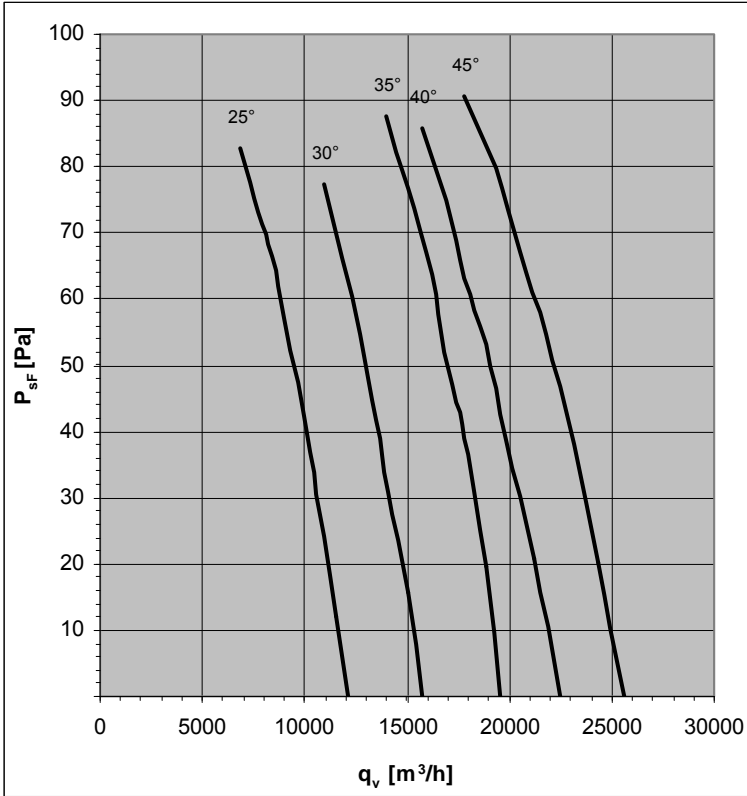

Design K

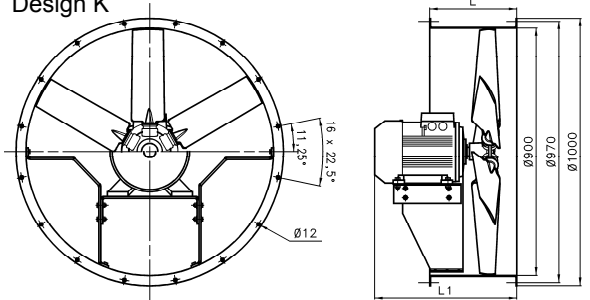

Design F

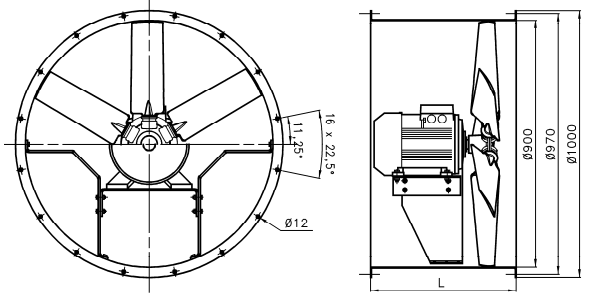

Pitch Angle	Relative spectrum LW dB(A)							
	63	125	250	500	1000	2000	4000	8000
25°	-41	-32	-14	-7	-4	-6	-10	-20
30°	-40	-31	-14	-7	-4	-5	-10	-19
35°	-39	-30	-14	-7	-4	-5	-9	-18
40°	-38	-30	-15	-7	-4	-5	-9	-17
45°	-38	-29	-15	-7	-4	-5	-8	-16

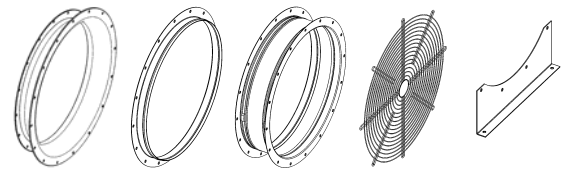

Accessories : see pages 104-106

Design	Pitch Angle	Type (G finish)	Part N°	Type (H finish)	Part N°	L1(mm)	L(mm)	Weight (kg)
K	25°	FV90V-8DK.C7.25.G	150653	FV90V-8DK.C7.25.H	150654	420	280	51
	30°	FV90V-8DK.D7.30.G	150657	FV90V-8DK.D7.30.H	150658	420	280	54
	35°	FV90V-8DK.E7.35.G	150661	FV90V-8DK.E7.35.H	150662	484	280	62
	40°	FV90V-8DK.E7.40.G	150665	FV90V-8DK.E7.40.H	150666	484	280	62
	45°	FV90V-8DK.E7.45.G	150669	FV90V-8DK.E7.45.H	150670	484	280	66
F	25°	FV90V-8DF.C7.25.G	150655	FV90V-8DF.C7.25.H	150656	---	500	66
	30°	FV90V-8DF.D7.30.G	150659	FV90V-8DF.D7.30.H	150660	---	500	69
	35°	FV90V-8DF.E7.35.G	150663	FV90V-8DF.E7.35.H	150664	---	500	76
	40°	FV90V-8DF.E7.40.G	150667	FV90V-8DF.E7.40.H	150668	---	500	76
	45°	FV90V-8DF.E7.45.G	150671	FV90V-8DF.E7.45.H	150672	---	500	80

FV10V-4D



50Hz Motor	U	I	P ₂	n	
	V	A	kW	min ⁻¹	
30°	132 M	400	14,5	7,5	1460
35°	160 M	400	21	11	1470
40°	160 L	400	28,4	15	1470
45°	180 M	400	34	18,5	1470
50°	200 L	400	53,9	30	1470

Standard Temperature Range : -30°C / +50°C

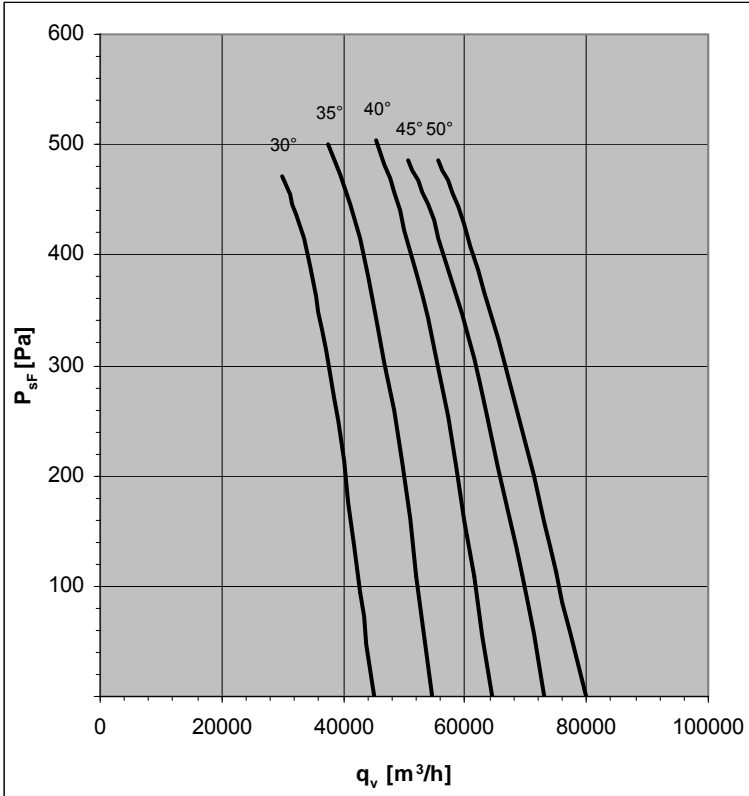

Design K

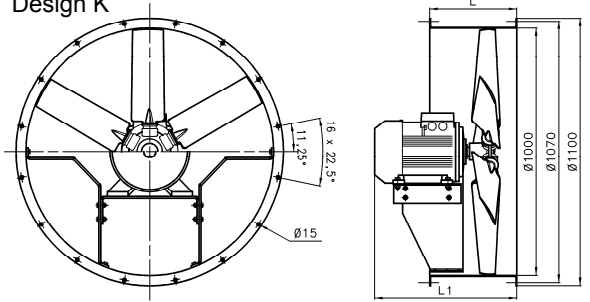

Design F

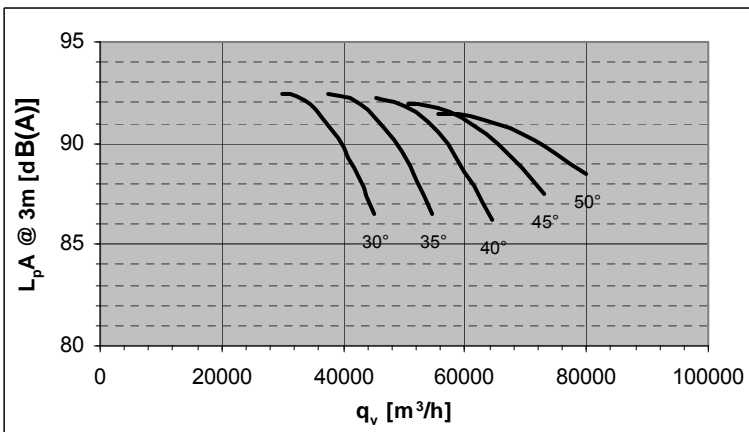
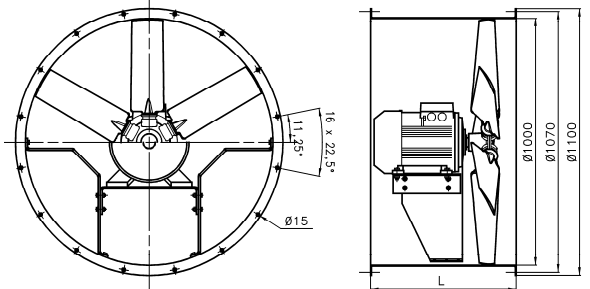

Pitch Angle	Relative spectrum LW dB(A)							
	63	125	250	500	1000	2000	4000	8000
30°	-52	-41	-18	-9	-5	-7	-13	-25
35°	-51	-40	-18	-9	-5	-7	-12	-24
40°	-49	-39	-18	-9	-5	-7	-12	-22
45°	-49	-38	-19	-9	-5	-6	-11	-21
50°	-48	-37	-19	-9	-5	-6	-10	-20

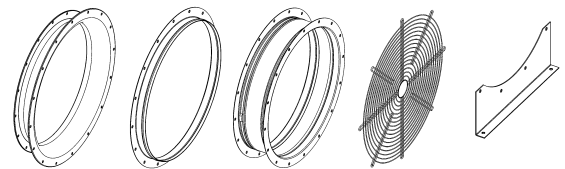

Accessories : see pages 104-106

Design	Pitch Angle	Type (G finish)	Part N°	Type (H finish)	Part N°	L1(mm)	L(mm)	Weight (kg)
K	30°	FV10V-4DK.H7.30.G	150693	FV10V-4DK.H7.30.H	150694	562	400	127
	35°	FV10V-4DK.I7.35.G	150697	FV10V-4DK.I7.35.H	150698	702	400	209
	40°	FV10V-4DK.K7.40.G	150701	FV10V-4DK.K7.40.H	150702	757	400	219
	45°	FV10V-4DK.L7.45.G	150705	FV10V-4DK.L7.45.H	150706	826	450	282
	50°	FV10V-4DK.N7.50.G	150709	FV10V-4DK.N7.50.H	150710	856	450	367
F	30°	FV10V-4DF.H7.30.G	150695	FV10V-4DF.H7.30.H	150696	---	700	150
	35°	FV10V-4DF.I7.35.G	150699	FV10V-4DF.I7.35.H	150700	---	700	231
	40°	FV10V-4DF.K7.40.G	150703	FV10V-4DF.K7.40.H	150704	---	700	241
	45°	FV10V-4DF.L7.45.G	150707	FV10V-4DF.L7.45.H	150708	---	860	313
	50°	FV10V-4DF.N7.50.G	150711	FV10V-4DF.N7.50.H	150712	---	860	398

FV10V-6D



50Hz Motor	U	I	P ₂	n	
	V	A	kW	min ⁻¹	
30°	112 M	400	5,11	2,2	960
35°	132 S	400	6,84	3	960
40°	132 M	400	8,98	4	960
45°	132 M	400	12	5,5	960
50°	160 M	400	15,9	7,5	970

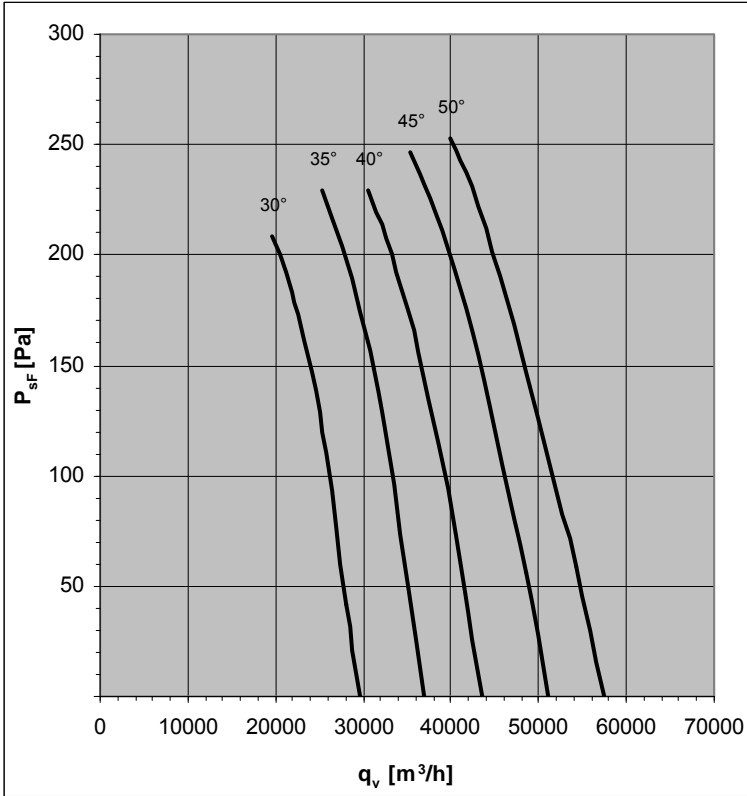

Design K

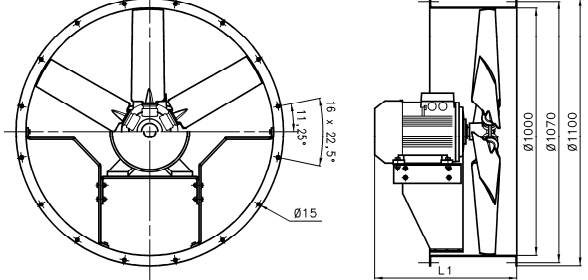

Design F

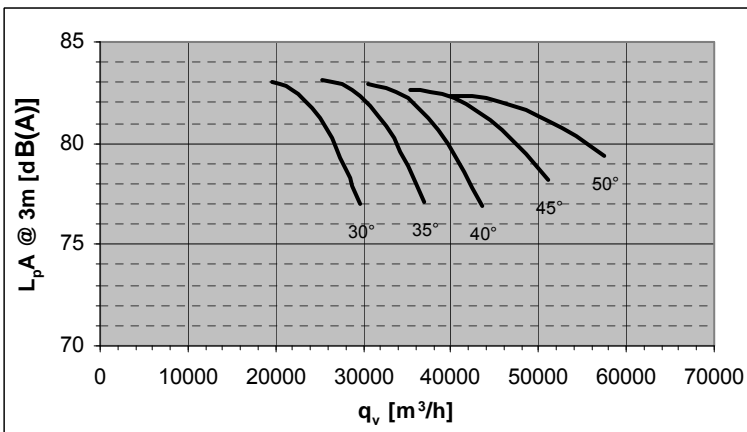
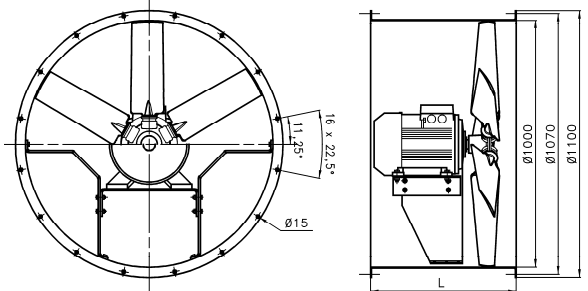

Pitch Angle	Relative spectrum LW dB(A)							
	63	125	250	500	1000	2000	4000	8000
30°	-47	-37	-16	-8	-4	-6	-12	-23
35°	-46	-36	-17	-8	-4	-6	-11	-22
40°	-45	-35	-17	-8	-4	-6	-11	-20
45°	-44	-34	-17	-8	-4	-6	-10	-19
50°	-44	-34	-17	-9	-4	-6	-9	-19

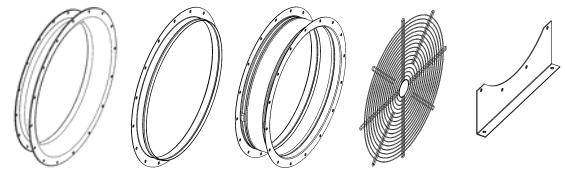

Accessories : see pages 104-106

Design	Pitch Angle	Type (G finish)	Part N°	Type (H finish)	Part N°	L1(mm)	L(mm)	Weight (kg)
K	30°	FV10V-6DK.F7.30.G	150713	FV10V-6DK.F7.30.H	150714	488	400	97
	35°	FV10V-6DK.G7.35.G	150717	FV10V-6DK.G7.35.H	150718	562	400	107
	40°	FV10V-6DK.H7.40.G	150721	FV10V-6DK.H7.40.H	150722	600	400	116
	45°	FV10V-6DK.H7.45.G	150725	FV10V-6DK.H7.45.H	150726	600	400	127
	50°	FV10V-6DK.I7.50.G	150729	FV10V-6DK.I7.50.H	150730	702	400	222
F	30°	FV10V-6DF.F7.30.G	150715	FV10V-6DF.F7.30.H	150716	---	700	119
	35°	FV10V-6DF.G7.35.G	150719	FV10V-6DF.G7.35.H	150720	---	700	130
	40°	FV10V-6DF.H7.40.G	150723	FV10V-6DF.H7.40.H	150724	---	700	139
	45°	FV10V-6DF.H7.45.G	150727	FV10V-6DF.H7.45.H	150728	---	700	149
	50°	FV10V-6DF.I7.50.G	150731	FV10V-6DF.I7.50.H	150732	---	700	244

FV10V-8D



50Hz Motor	U	I	P ₂	n	
	V	A	kW	min ⁻¹	
30°	112 M	400	4,2	1,5*	720
35°	112 M	400	4,2	1,5*	720
40°	132 S	400	6,6	2,2*	725
45°	132 S	400	6,6	2,2*	725
50°	132 M	400	7,9	3*	730

*out of IE2 standard scope

Standard Temperature Range : -30°C / +50°C

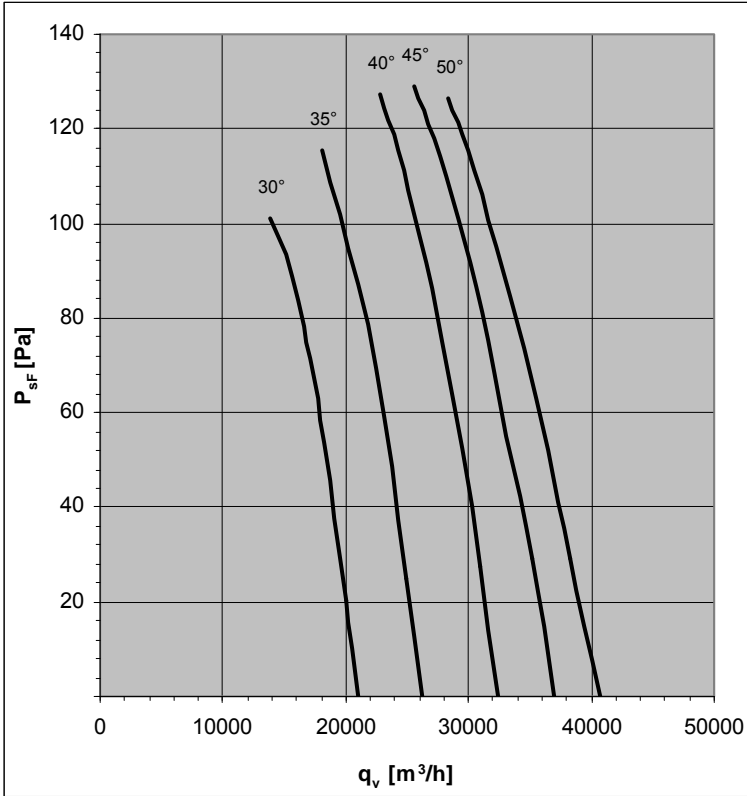

Design K

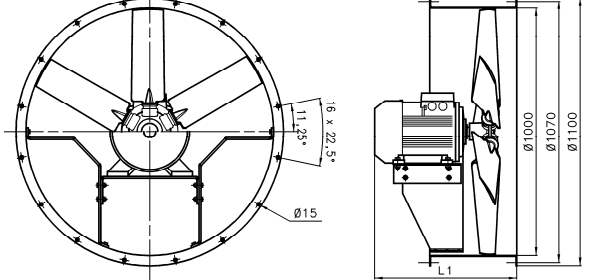

Design F

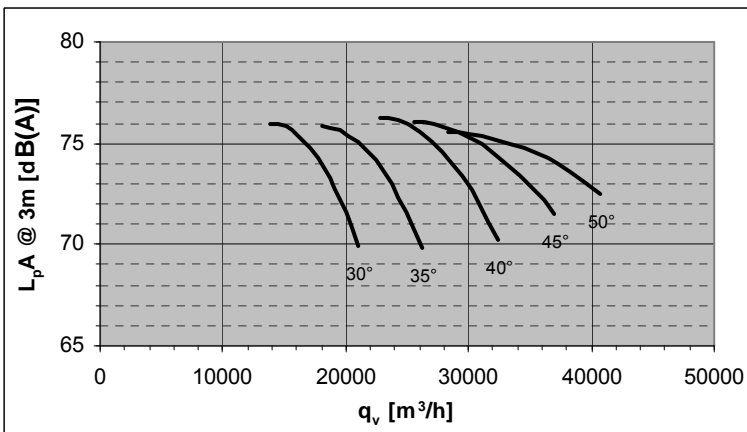
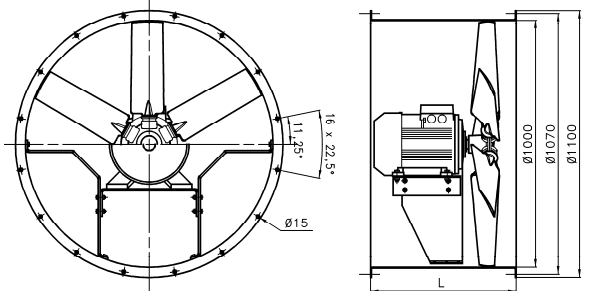

Pitch Angle	Relative spectrum LW dB(A)							
	63	125	250	500	1000	2000	4000	8000
30°	-44	-35	-15	-7	-4	-6	-11	-21
35°	-43	-34	-15	-7	-4	-6	-10	-20
40°	-42	-33	-15	-8	-4	-6	-10	-19
45°	-41	-32	-16	-8	-4	-5	-9	-18
50°	-41	-31	-16	-8	-4	-5	-9	-17

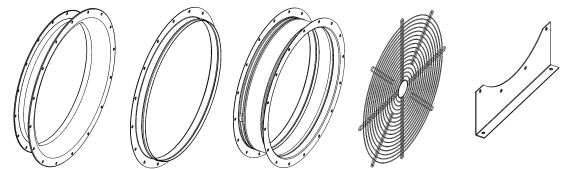

Accessories : see pages 104-106

Design	Pitch Angle	Type (G finish)	Part N°	Type (H finish)	Part N°	L1(mm)	L(mm)	Weight (kg)
K	30°	FV10V-8DK.F7.30.G	150733	FV10V-8DK.F7.30.H	150734	476	400	92
	35°	FV10V-8DK.F7.35.G	150737	FV10V-8DK.F7.35.H	150738	476	400	92
	40°	FV10V-8DK.G7.40.G	150741	FV10V-8DK.G7.40.H	150742	552	400	104
	45°	FV10V-8DK.G7.45.G	150745	FV10V-8DK.G7.45.H	150746	552	400	104
	50°	FV10V-8DK.H7.50.G	150749	FV10V-8DK.H7.50.H	150750	552	400	112
F	30°	FV10V-8DF.F7.30.G	150735	FV10V-8DF.F7.30.H	150736	---	700	115
	35°	FV10V-8DF.F7.35.G	150739	FV10V-8DF.F7.35.H	150740	---	700	115
	40°	FV10V-8DF.G7.40.G	150743	FV10V-8DF.G7.40.H	150744	---	700	127
	45°	FV10V-8DF.G7.45.G	150747	FV10V-8DF.G7.45.H	150748	---	700	127
	50°	FV10V-8DF.H7.50.G	150751	FV10V-8DF.H7.50.H	150752	---	700	135

FV12V-4D



50Hz Motor	U	I	P ₂	n	
	V	A	kW	min ⁻¹	
22°	180 M	400	34	18,5	1470
24°	180 L	400	39,8	22	1470
29°	200 L	400	53,9	30	1470
32°	225 S	400	66,2	37	1480
36°	225 M	400	80,2	45	1480

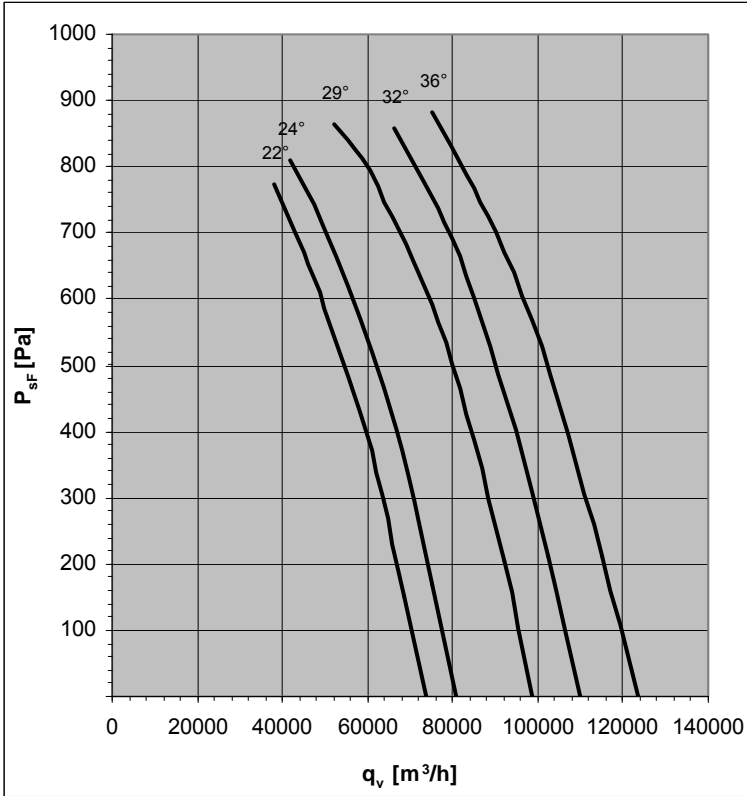

Design K

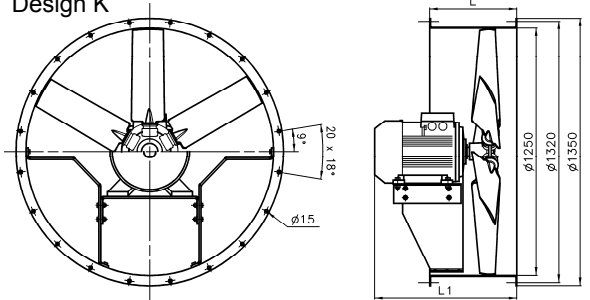

Design F

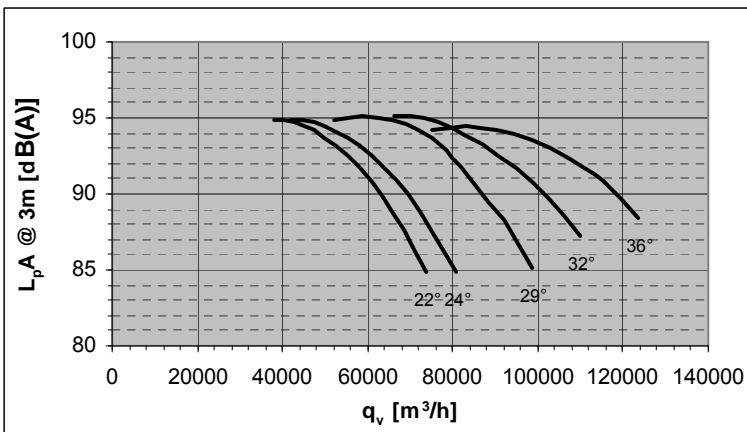
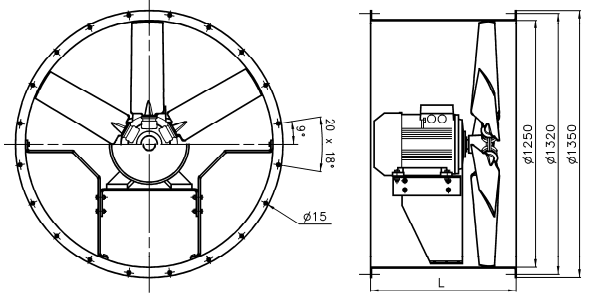

Pitch Angle	Relative spectrum LW dB(A)							
	63	125	250	500	1000	2000	4000	8000
22°	-51	-40	-18	-9	-5	-7	-13	-25
24°	-50	-39	-18	-9	-5	-7	-12	-23
29°	-49	-38	-18	-9	-5	-7	-12	-22
32°	-48	-38	-19	-9	-5	-6	-11	-21
36°	-48	-37	-19	-9	-5	-6	-10	-20

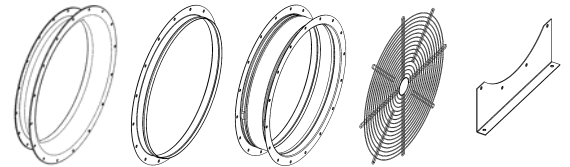

Accessories : see pages 104-106

Design	Pitch Angle	Type (G finish)	Part N°	Type (H finish)	Part N°	L1(mm)	L(mm)	Weight (kg)
K	22°	FV12V-4DK.L7.22.G	150785	FV12V-4DK.L7.22.H	150786	869	500	311
	24°	FV12V-4DK.M7.24.G	150789	FV12V-4DK.M7.24.H	150790	869	500	326
	29°	FV12V-4DK.N7.29.G	150793	FV12V-4DK.N7.29.H	150794	899	500	396
	32°	FV12V-4DK.P7.32.G	150797	FV12V-4DK.P7.32.H	150798	944	500	436
	36°	FV12V-4DK.R7.36.G	150801	FV12V-4DK.R7.36.H	150802	974	500	466
F	22°	FV12V-4DF.L7.22.G	150787	FV12V-4DF.L7.22.H	150788	---	1000	351
	24°	FV12V-4DF.M7.24.G	150791	FV12V-4DF.M7.24.H	150792	---	1000	366
	29°	FV12V-4DF.N7.29.G	150795	FV12V-4DF.N7.29.H	150796	---	1000	436
	32°	FV12V-4DF.P7.32.G	150799	FV12V-4DF.P7.32.H	150800	---	1000	476
	36°	FV12V-4DF.R7.36.G	150803	FV12V-4DF.R7.36.H	150804	---	1000	506

FV12V-6D



50Hz Motor	U	I	P ₂	n	
	V	A	kW	min ⁻¹	
23°	132 M	400	12	5,5	960
27°	160 M	400	15,9	7,5	970
34°	160 L	400	22,7	11	970
39°	180 L	400	29,4	15	970
43°	200 L	400	36,5	18,5	970

Standard Temperature Range : -30°C / +50°C

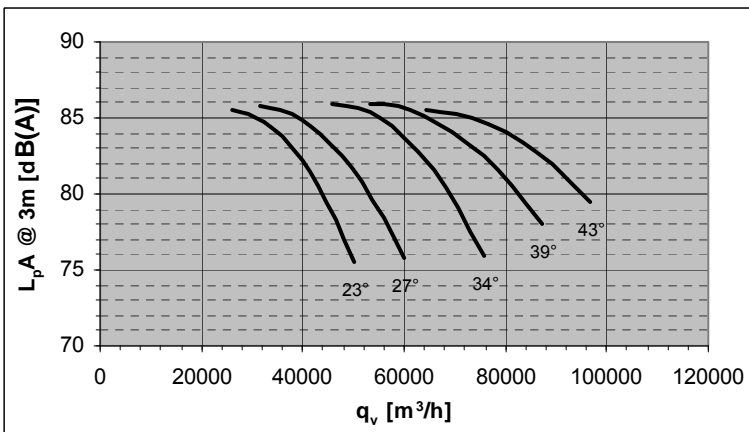
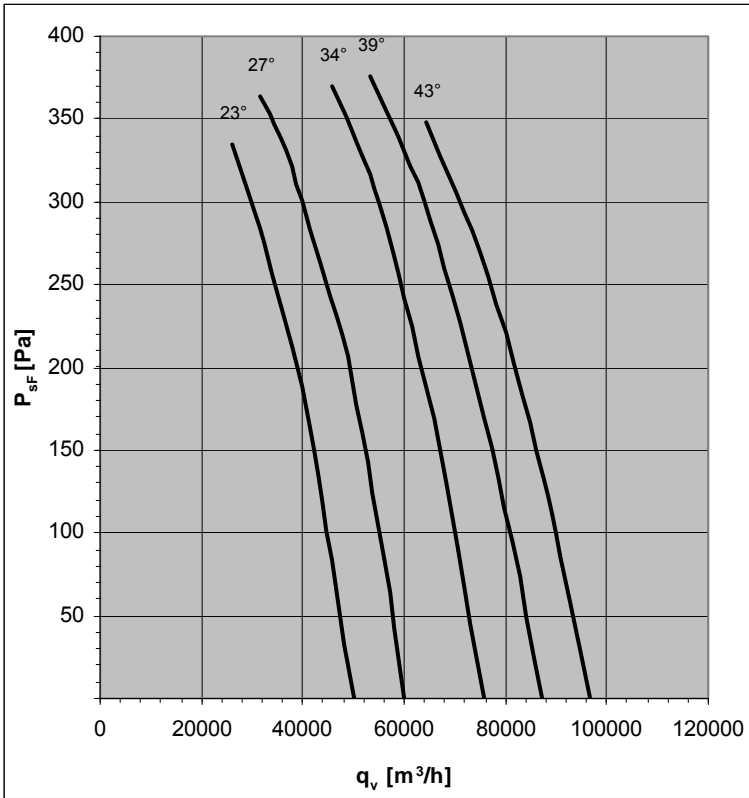

Design K

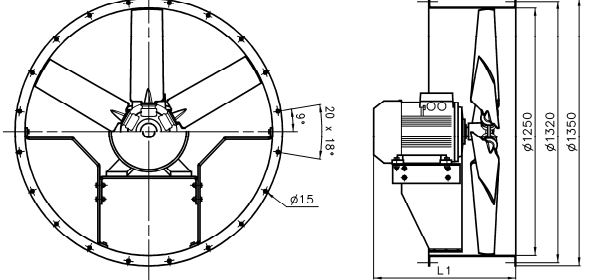

Design F

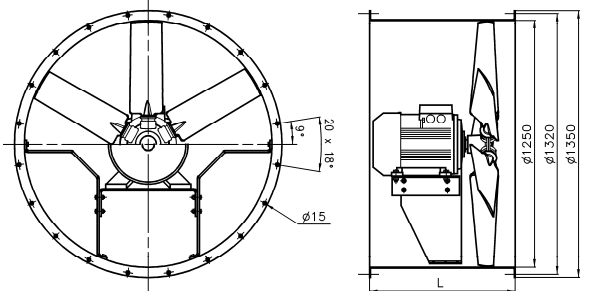

Pitch Angle	Relative spectrum LW dB(A)							
	63	125	250	500	1000	2000	4000	8000
23°	-47	-37	-16	-8	-4	-6	-12	-22
27°	-45	-36	-16	-8	-4	-6	-11	-21
34°	-44	-35	-17	-8	-4	-6	-10	-20
39°	-44	-34	-17	-8	-4	-6	-10	-19
43°	-44	-34	-17	-9	-4	-6	-9	-19

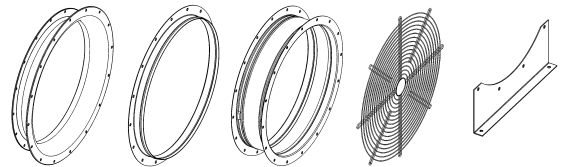

Accessories : see pages 104-106

Design	Pitch Angle	Type (G finish)	Part N°	Type (H finish)	Part N°	L1(mm)	L(mm)	Weight (kg)
K	23°	FV12V-6DK.H7.23.G	150805	FV12V-6DK.H7.23.H	150806	662	500	164
	27°	FV12V-6DK.I7.27.G	150809	FV12V-6DK.I7.27.H	150810	764	500	251
	34°	FV12V-6DK.K7.34.G	150813	FV12V-6DK.K7.34.H	150814	819	500	267
	39°	FV12V-6DK.M7.39.G	150817	FV12V-6DK.M7.39.H	150818	869	500	324
	43°	FV12V-6DK.N7.43.G	150821	FV12V-6DK.N7.43.H	150822	899	500	362
F	23°	FV12V-6DF.H7.23.G	150807	FV12V-6DF.H7.23.H	150808	---	760	187
	27°	FV12V-6DF.I7.27.G	150811	FV12V-6DF.I7.27.H	150812	---	760	274
	34°	FV12V-6DF.K7.34.G	150815	FV12V-6DF.K7.34.H	150816	---	760	290
	39°	FV12V-6DF.M7.39.G	150819	FV12V-6DF.M7.39.H	150820	---	1000	364
	43°	FV12V-6DF.N7.43.G	150823	FV12V-6DF.N7.43.H	150824	---	1000	402

FV12V-8D



50Hz Motor	U	I	P ₂	n	
	V	A	kW	min ⁻¹	
28°	132 M	400	7,9	3*	730
31°	160 M	400	9,39	4*	720
38°	160 M	400	12,5	5,5*	720
43°	160 L	400	16,8	7,5*	720
50°	180 L	400	23,8	11*	730

*out of IE2 standard scope

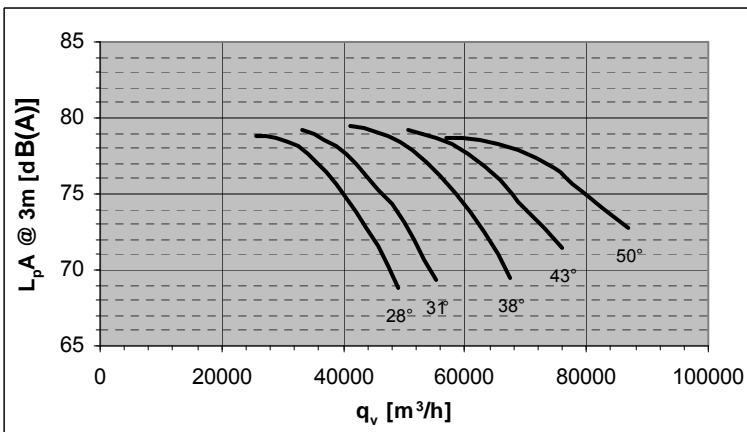
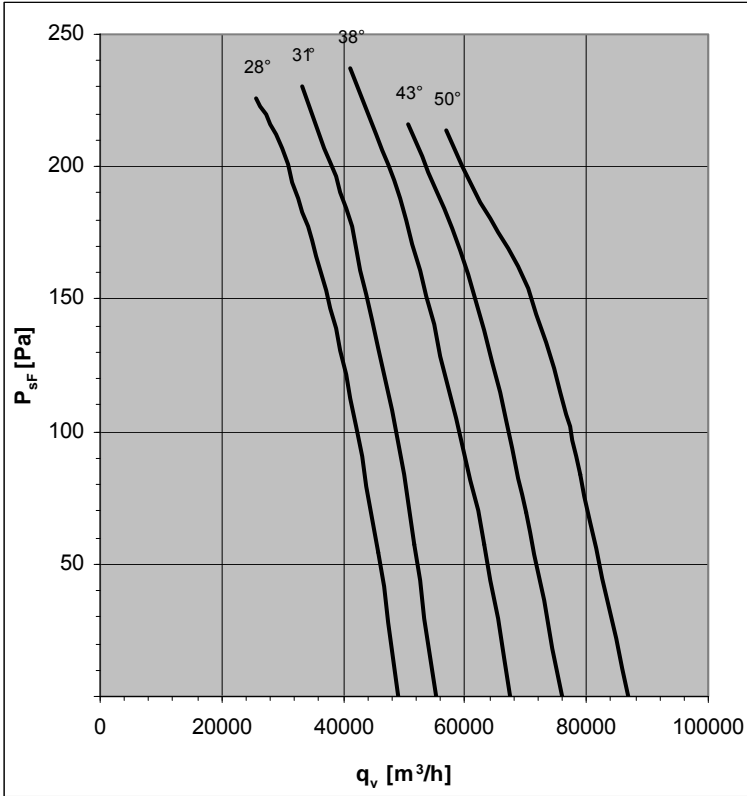

Design K

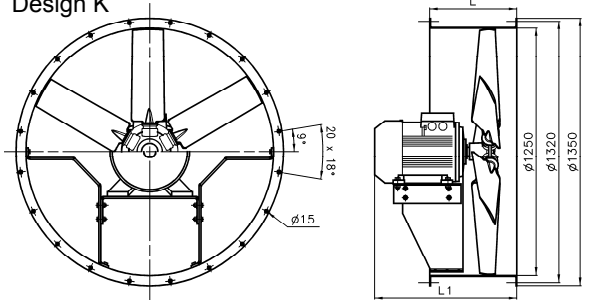

Design F

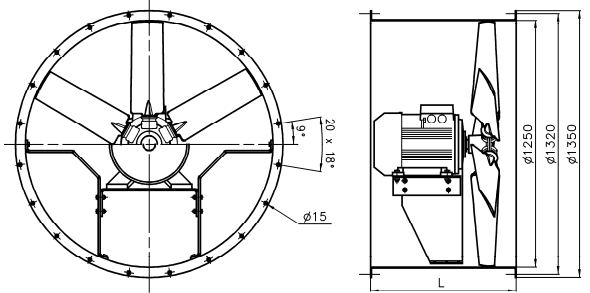

Pitch Angle	Relative spectrum LW dB(A)							
	63	125	250	500	1000	2000	4000	8000
28°	-43	-34	-15	-7	-4	-6	-11	-21
31°	-42	-33	-15	-7	-4	-6	-10	-20
38°	-41	-32	-15	-8	-4	-6	-10	-19
43°	-41	-32	-16	-8	-4	-5	-9	-18
50°	-41	-31	-16	-8	-4	-5	-9	-17

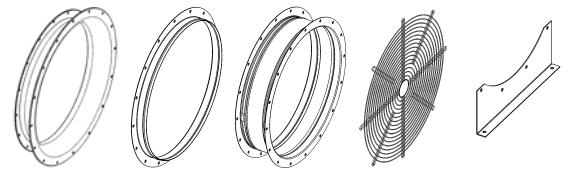

Accessories : see pages 104-106

Design	Pitch Angle	Type (G finish)	Part N°	Type (H finish)	Part N°	L1(mm)	L(mm)	Weight (kg)
K	28°	FV12V-8DK.H7.28.G	150825	FV12V-8DK.H7.28.H	150826	614	500	149
	31°	FV12V-8DK.I7.31.G	150829	FV12V-8DK.I7.31.H	150830	764	500	233
	38°	FV12V-8DK.I7.38.G	150833	FV12V-8DK.I7.38.H	150834	764	500	255
	43°	FV12V-8DK.K7.43.G	150837	FV12V-8DK.K7.43.H	150838	794	500	260
	50°	FV12V-8DK.M7.50.G	150841	FV12V-8DK.M7.50.H	150842	869	500	354
F	28°	FV12V-8DF.H7.28.G	150827	FV12V-8DF.H7.28.H	150828	---	760	172
	31°	FV12V-8DF.I7.31.G	150831	FV12V-8DF.I7.31.H	150832	---	760	256
	38°	FV12V-8DF.I7.38.G	150835	FV12V-8DF.I7.38.H	150836	---	760	278
	43°	FV12V-8DF.K7.43.G	150839	FV12V-8DF.K7.43.H	150840	---	760	283
	50°	FV12V-8DF.M7.50.G	150843	FV12V-8DF.M7.50.H	150844	---	1000	394

FV14V-6D



50Hz Motor	U	I	P ₂	n	
	V	A	kW	min ⁻¹	
22°	160 L	400	22,7	11	970
27°	180 L	400	29,4	15	970
29°	200 L	400	36,5	18,5	970
32°	200 L	400	43,1	22	970
38°	225 M	400	56,2	30	980

Standard Temperature Range : -30°C / +50°C

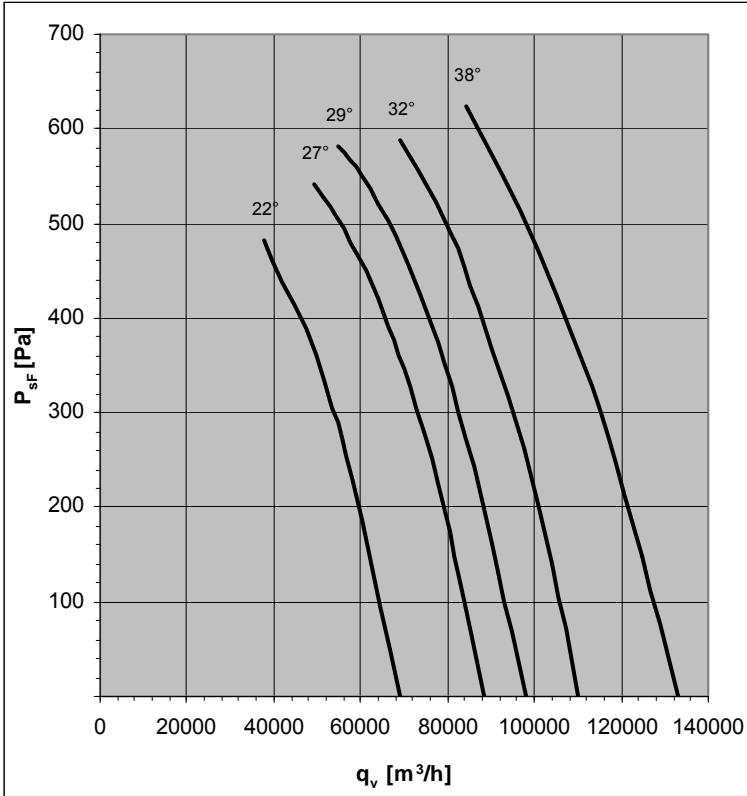

Design K

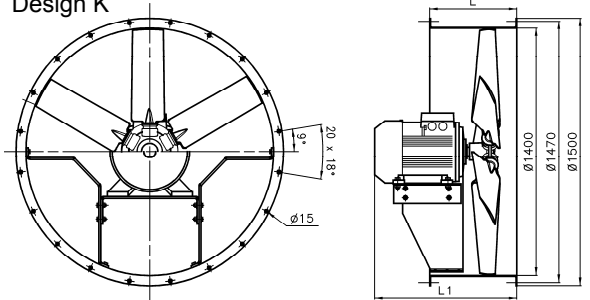

Design F

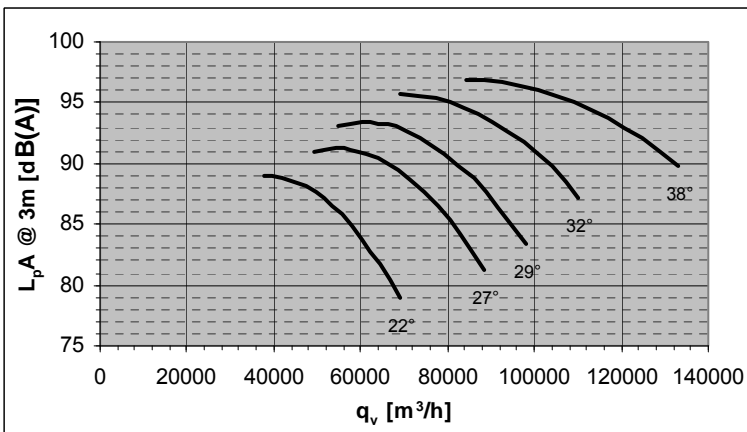
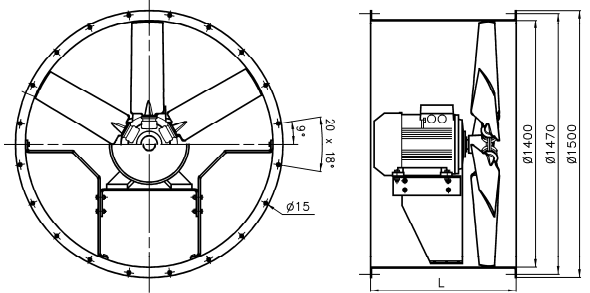

Pitch Angle	Relative spectrum LW dB(A)							
	63	125	250	500	1000	2000	4000	8000
22°	-48	-38	-17	-8	-5	-7	-12	-23
27°	-48	-38	-17	-8	-5	-7	-12	-23
29°	-48	-37	-18	-9	-5	-6	-11	-22
32°	-48	-38	-19	-9	-5	-6	-11	-21
38°	-48	-37	-19	-9	-5	-6	-10	-21

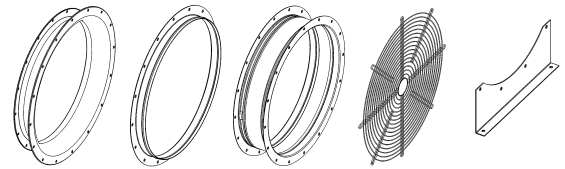

Accessories : see pages 104-106

Design	Pitch Angle	Type (G finish)	Part N°	Type (H finish)	Part N°	L1(mm)	L(mm)	Weight (kg)
K	22°	FV14V-6DK.K7.22.G	150901	FV14V-6DK.K7.22.H	150902	819	500	301
	27°	FV14V-6DK.M7.27.G	150905	FV14V-6DK.M7.27.H	150906	869	500	361
	29°	FV14V-6DK.N7.29.G	150909	FV14V-6DK.N7.29.H	150910	899	500	399
	32°	FV14V-6DK.N7.32.G	150913	FV14V-6DK.N7.32.H	150914	899	500	414
	38°	FV14V-6DK.R7.38.G	150917	FV14V-6DK.R7.38.H	150918	974	500	480
F	22°	FV14V-6DF.K7.22.G	150903	FV14V-6DF.K7.22.H	150904	---	760	336
	27°	FV14V-6DF.M7.27.G	150907	FV14V-6DF.M7.27.H	150908	---	1000	420
	29°	FV14V-6DF.N7.29.G	150911	FV14V-6DF.N7.29.H	150912	---	1000	458
	32°	FV14V-6DF.N7.32.G	150915	FV14V-6DF.N7.32.H	150916	---	1000	473
	38°	FV14V-6DF.R7.38.G	150919	FV14V-6DF.R7.38.H	150920	---	1000	539

FV14V-8D



50Hz Motor	U	I	P ₂	n	
	V	A	kW	min ⁻¹	
25°	160 M	400	12,5	5,5*	720
30°	160 L	400	16,8	7,5*	720
36°	180 L	400	23,8	11*	730
42°	200 L	400	31,7	15*	730
47°	225 S	400	38,7	18,5*	730

*out of IE2 standard scope

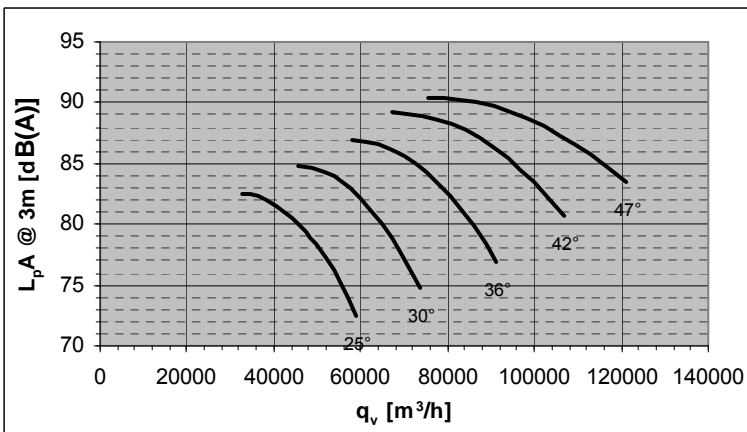
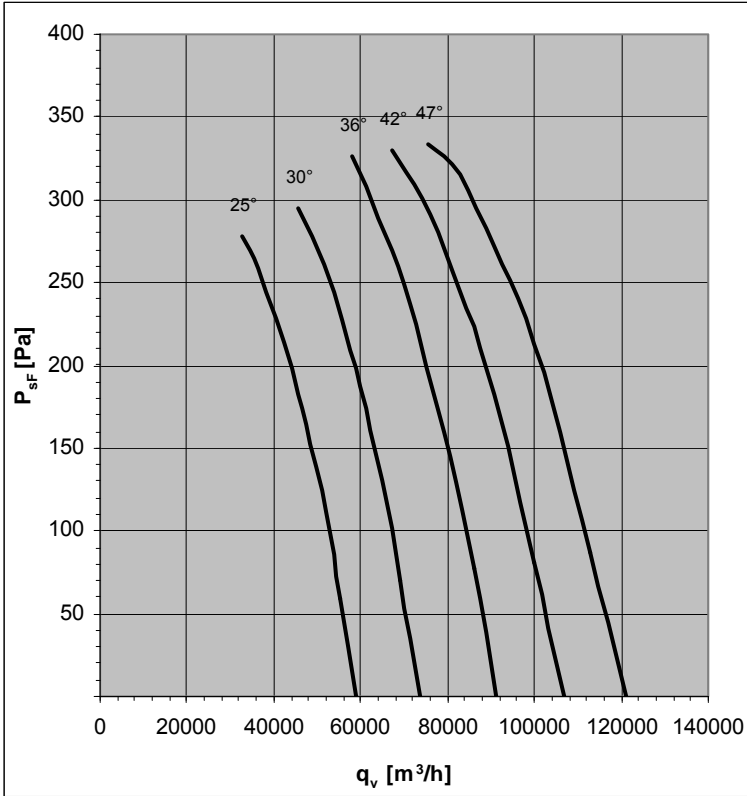

Design K

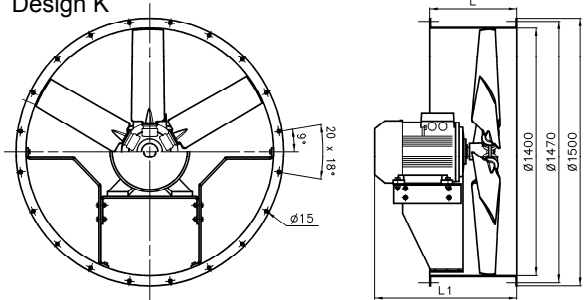

Design F

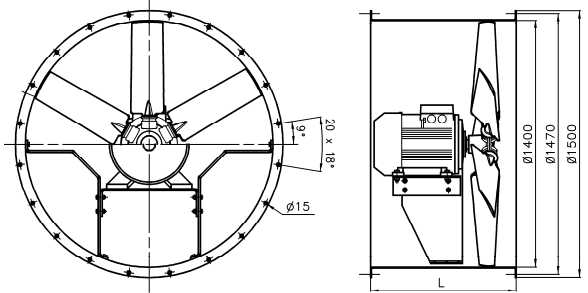

Pitch Angle	Relative spectrum LW dB(A)							
	63	125	250	500	1000	2000	4000	8000
25°	-45	-36	-16	-8	-4	-6	-12	-22
30°	-45	-35	-16	-8	-4	-6	-11	-21
36°	-45	-35	-17	-8	-4	-6	-11	-20
42°	-45	-35	-18	-9	-5	-6	-10	-20
47°	-45	-35	-18	-9	-5	-6	-10	-19

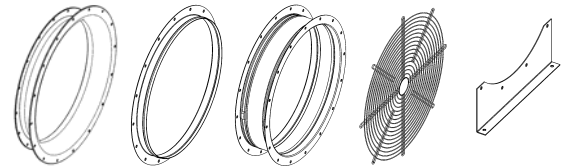

Accessories : see pages 104-106

Design	Pitch Angle	Type (G finish)	Part N°	Type (H finish)	Part N°	L1(mm)	L(mm)	Weight (kg)
K	25°	FV14V-8DK.I7.25.G	150921	FV14V-8DK.I7.25.H	150922	764	500	289
	30°	FV14V-8DK.K7.30.G	150925	FV14V-8DK.K7.30.H	150926	794	500	294
	36°	FV14V-8DK.M7.36.G	150929	FV14V-8DK.M7.36.H	150930	869	500	391
	42°	FV14V-8DK.N7.42.G	150933	FV14V-8DK.N7.42.H	150934	899	500	397
	47°	FV14V-8DK.P7.47.G	150937	FV14V-8DK.P7.47.H	150938	944	500	439
F	25°	FV14V-8DF.I7.25.G	150923	FV14V-8DF.I7.25.H	150924	---	760	324
	30°	FV14V-8DF.K7.30.G	150927	FV14V-8DF.K7.30.H	150928	---	760	329
	36°	FV14V-8DF.M7.36.G	150931	FV14V-8DF.M7.36.H	150932	---	1000	450
	42°	FV14V-8DF.N7.42.G	150935	FV14V-8DF.N7.42.H	150936	---	1000	456
	47°	FV14V-8DF.P7.47.G	150939	FV14V-8DF.P7.47.H	150940	---	1000	498

Increased Temperature Range

Working Temperature : - 30°C / + 60°C

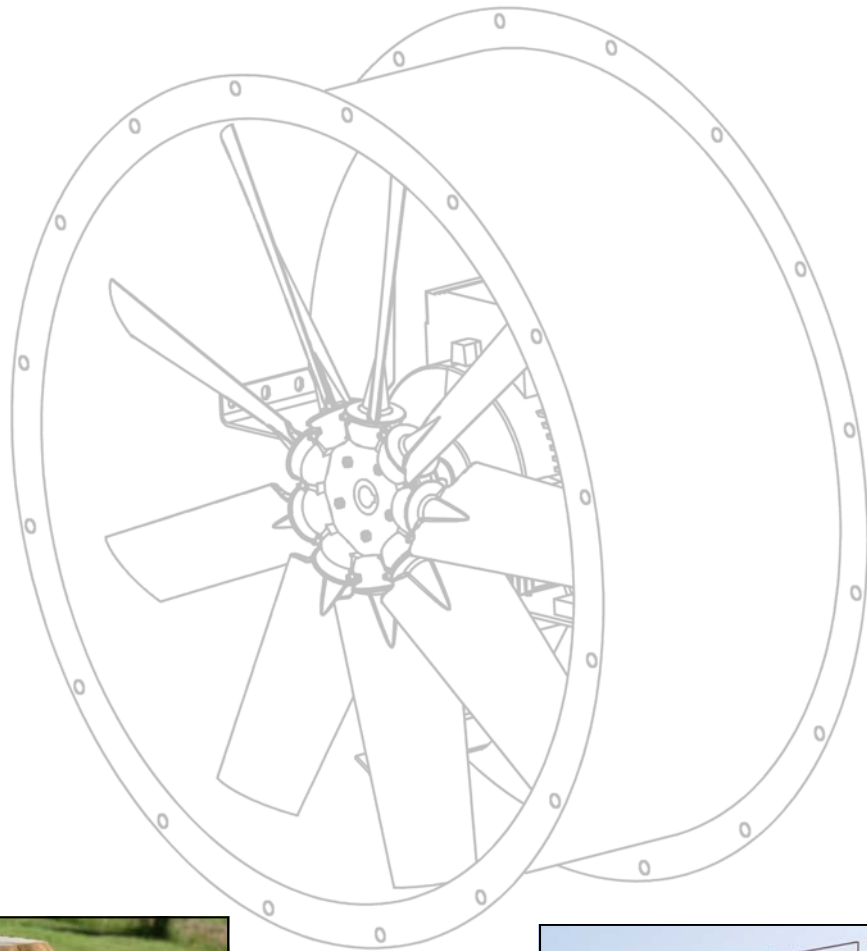

Increased Temperature Range : -30°C / +60°C

FV31V-2D



50Hz Motor	U	I	P ₂	n	
	V	A	kW	min ⁻¹	
25°	71 M	400	1	0,37*	2740
30°	71 M	400	1	0,37*	2740
35°	71 M	400	1,36	0,55*	2800
40°	80 M	400	1,75	0,75	2855
45°	80 M	400	2,4	1,1	2870

*out of IE2 standard scope

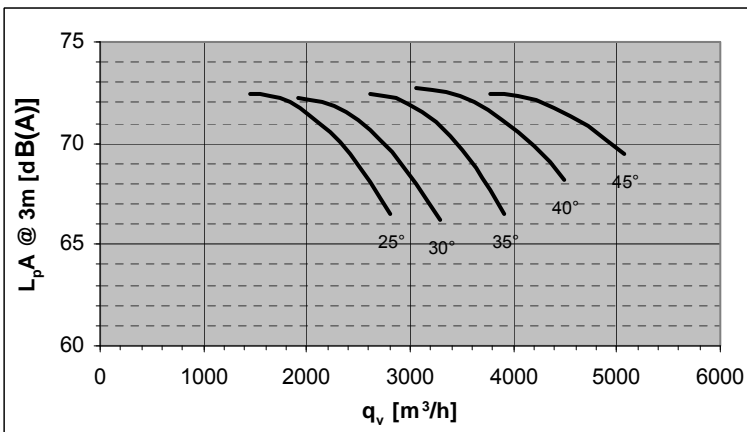
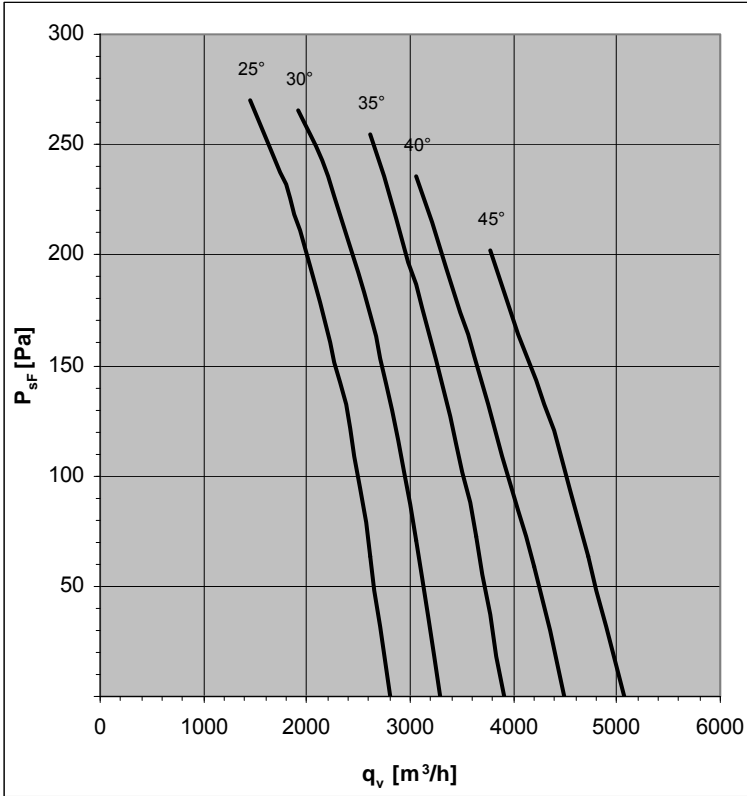

Design K

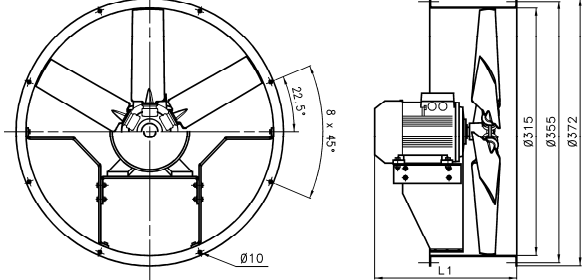

Design F

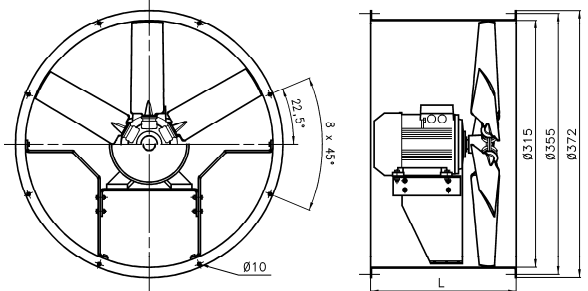

Pitch Angle	Relative spectrum LW dB(A)							
	63	125	250	500	1000	2000	4000	8000
25°	-42	-33	-15	-7	-4	-6	-11	-20
30°	-41	-32	-15	-7	-4	-6	-10	-19
35°	-40	-31	-15	-7	-4	-5	-9	-18
40°	-40	-31	-15	-7	-4	-5	-9	-17
45°	-39	-30	-16	-8	-4	-5	-8	-17

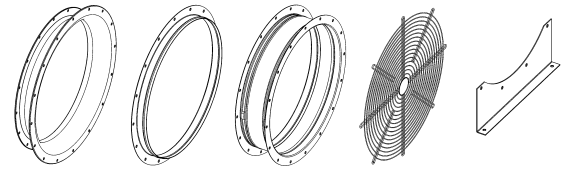

Accessories : see pages 104-106

Design	Pitch Angle	Type (G finish)	Part N°	Type (H finish)	Part N°	L1(mm)	L(mm)	Weight (kg)
K	25°	FV31V-2DK.A7.25.G	150000	FV31V-2DK.A7.25.H	150001	304	260	15
	30°	FV31V-2DK.A7.30.G	150004	FV31V-2DK.A7.30.H	150005	304	260	15
	35°	FV31V-2DK.A7.35.G	150008	FV31V-2DK.A7.35.H	150009	304	260	16
	40°	FV31V-2DK.B7.40.G	150040	FV31V-2DK.B7.40.H	150041	338	260	19
	45°	FV31V-2DK.B7.45.G	150044	FV31V-2DK.B7.45.H	150045	351	260	24
F	25°	FV31V-2DF.A7.25.G	150002	FV31V-2DF.A7.25.H	150003	---	365	17
	30°	FV31V-2DF.A7.30.G	150006	FV31V-2DF.A7.30.H	150007	---	365	17
	35°	FV31V-2DF.A7.35.G	150010	FV31V-2DF.A7.35.H	150011	---	365	18
	40°	FV31V-2DF.B7.40.G	150042	FV31V-2DF.B7.40.H	150043	---	365	21
	45°	FV31V-2DF.B7.45.G	150046	FV31V-2DF.B7.45.H	150047	---	365	26

FV31V-4D



50Hz Motor	U	I	P ₂	n	
	V	A	kW	min ⁻¹	
25°	56 M	400	0,2	0,06*	1350
30°	56 M	400	0,2	0,06*	1350
35°	56 M	400	0,2	0,06*	1350
40°	56 M	400	0,29	0,09*	1350
45°	56 M	400	0,29	0,09*	1350

*out of IE2 standard scope

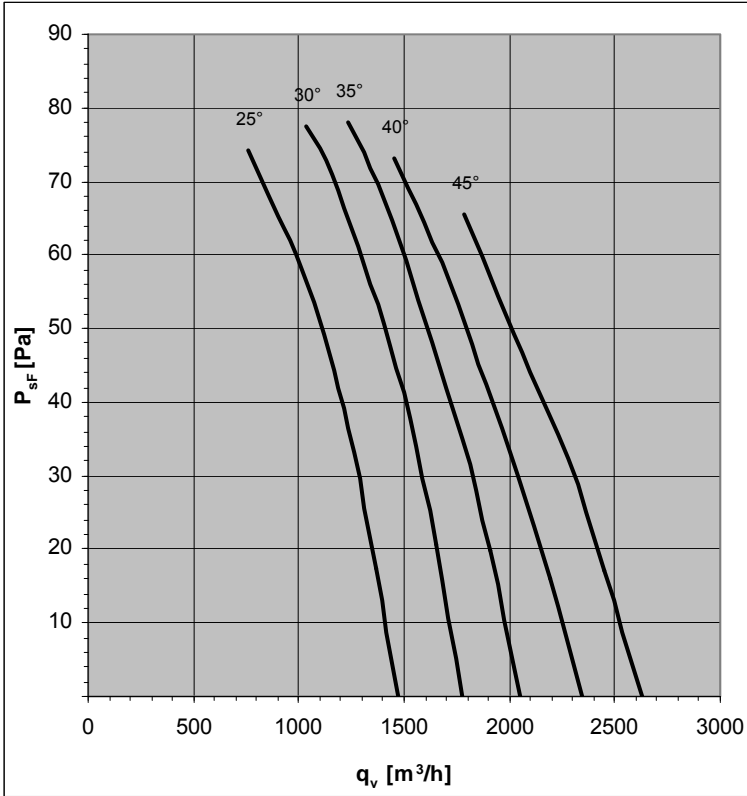

Design K

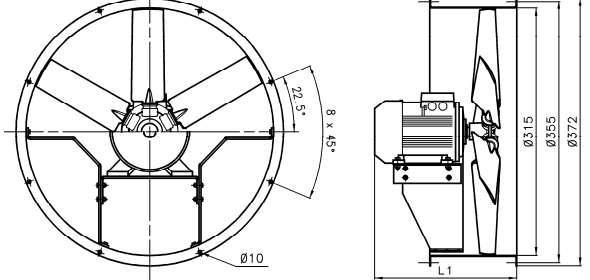

Design F

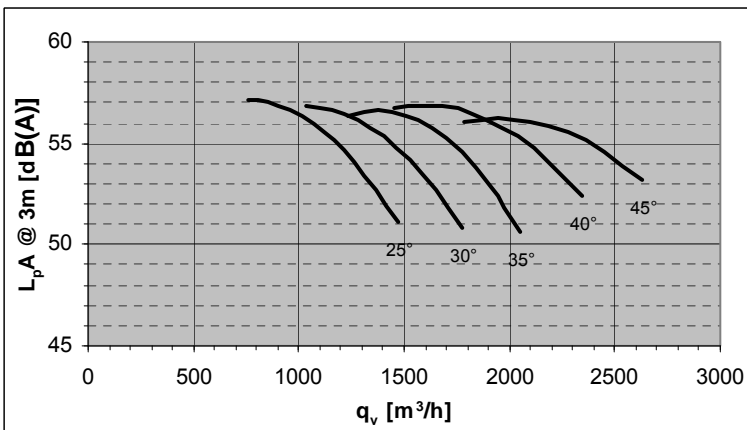
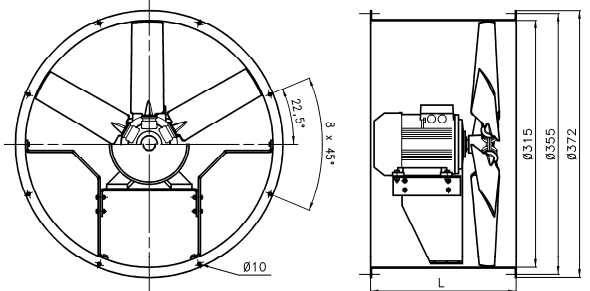

Pitch Angle	Relative spectrum LW dB(A)							
	63	125	250	500	1000	2000	4000	8000
25°	-34	-27	-12	-6	-3	-5	-9	-17
30°	-33	-26	-12	-6	-3	-5	-8	-16
35°	-32	-25	-12	-6	-3	-4	-8	-15
40°	-32	-25	-12	-6	-3	-4	-7	-14
45°	-32	-25	-13	-6	-3	-4	-7	-14

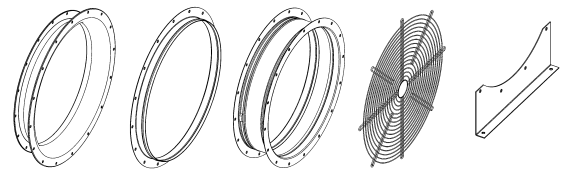

Accessories : see pages 104-106

Design	Pitch Angle	Type (G finish)	Part N°	Type (H finish)	Part N°	L1(mm)	L(mm)	Weight (kg)
K	25°	FV31V-4DK.87.25.G	150020	FV31V-4DK.87.25.H	150021	269	260	12
	30°	FV31V-4DK.87.30.G	150024	FV31V-4DK.87.30.H	150025	269	260	12
	35°	FV31V-4DK.87.35.G	150028	FV31V-4DK.87.35.H	150029	269	260	12
	40°	FV31V-4DK.87.40.G	150048	FV31V-4DK.87.40.H	150049	269	260	12
	45°	FV31V-4DK.87.45.G	150036	FV31V-4DK.87.45.H	150037	269	260	12
F	25°	FV31V-4DF.87.25.G	150022	FV31V-4DF.87.25.H	150023	---	365	14
	30°	FV31V-4DF.87.30.G	150026	FV31V-4DF.87.30.H	150027	---	365	14
	35°	FV31V-4DF.87.35.G	150030	FV31V-4DF.87.35.H	150031	---	365	14
	40°	FV31V-4DF.87.40.G	150050	FV31V-4DF.87.40.H	150051	---	365	14
	45°	FV31V-4DF.87.45.G	150038	FV31V-4DF.87.45.H	150039	---	365	14

FV35V-2D



50Hz Motor	U	I	P ₂	n	
	V	A	kW	min ⁻¹	
25°	80 M	400	1,75	0,75	2855
30°	80 M	400	2,4	1,1	2870
35°	80 M	400	2,4	1,1	2870
40°	90 S	400	3,13	1,5	2890
45°	90 S	400	3,13	1,5	2890

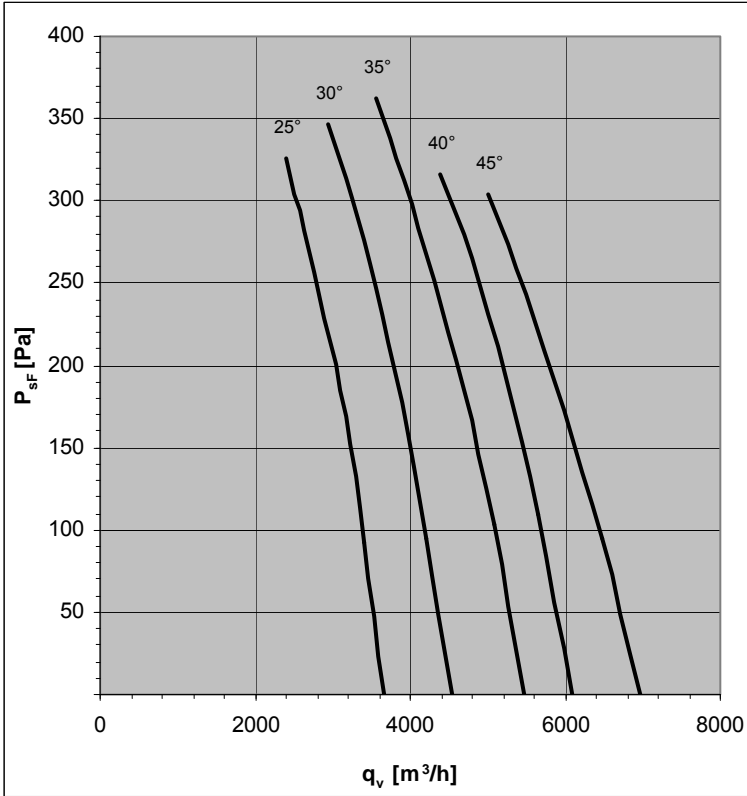

Design K

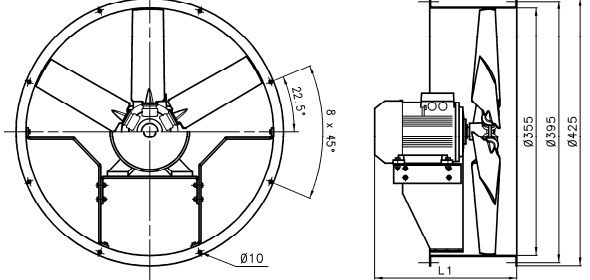

Design F

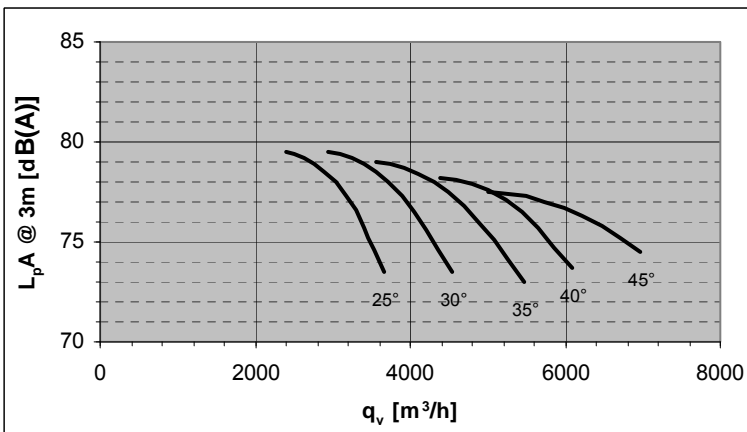
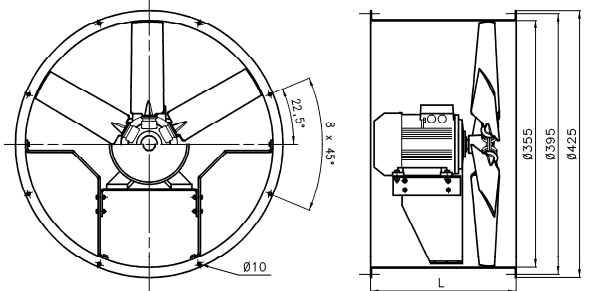

Pitch Angle	Relative spectrum LW dB(A)							
	63	125	250	500	1000	2000	4000	8000
25°	-46	-36	-16	-8	-4	-6	-12	-22
30°	-44	-35	-16	-8	-4	-6	-11	-21
35°	-43	-34	-16	-8	-4	-6	-10	-20
40°	-42	-33	-16	-8	-4	-6	-10	-19
45°	-41	-32	-17	-8	-4	-5	-9	-18

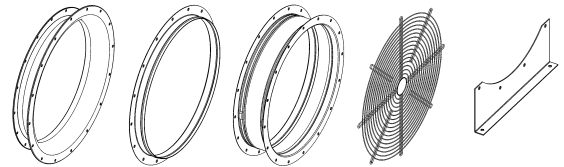

Accessories : see pages 104-106

Design	Pitch Angle	Type (G finish)	Part N°	Type (H finish)	Part N°	L1(mm)	L(mm)	Weight (kg)
K	25°	FV35V-2DK.B7.25.G	150092	FV35V-2DK.B7.25.H	150093	338	260	21
	30°	FV35V-2DK.B7.30.G	150096	FV35V-2DK.B7.30.H	150097	351	260	25
	35°	FV35V-2DK.B7.35.G	150060	FV35V-2DK.B7.35.H	150061	351	260	25
	40°	FV35V-2DK.C7.40.G	150100	FV35V-2DK.C7.40.H	150101	372	260	29
	45°	FV35V-2DK.C7.45.G	150068	FV35V-2DK.C7.45.H	150069	372	260	29
F	25°	FV35V-2DF.B7.25.G	150094	FV35V-2DF.B7.25.H	150095	---	400	24
	30°	FV35V-2DF.B7.30.G	150098	FV35V-2DF.B7.30.H	150099	---	400	28
	35°	FV35V-2DF.B7.35.G	150062	FV35V-2DF.B7.35.H	150063	---	400	28
	40°	FV35V-2DF.C7.40.G	150102	FV35V-2DF.C7.40.H	150103	---	400	32
	45°	FV35V-2DF.C7.45.G	150070	FV35V-2DF.C7.45.H	150071	---	400	32

FV35V-4D



50Hz Motor	U	I	P ₂	n	
	V	A	kW	min ⁻¹	
25°	56 M	400	0,29	0,09*	1350
30°	56 M	400	0,29	0,09*	1350
35°	63 M	400	0,42	0,12*	1350
40°	63 M	400	0,58	0,18*	1350
45°	63 M	400	0,58	0,18*	1350

*out of IE2 standard scope

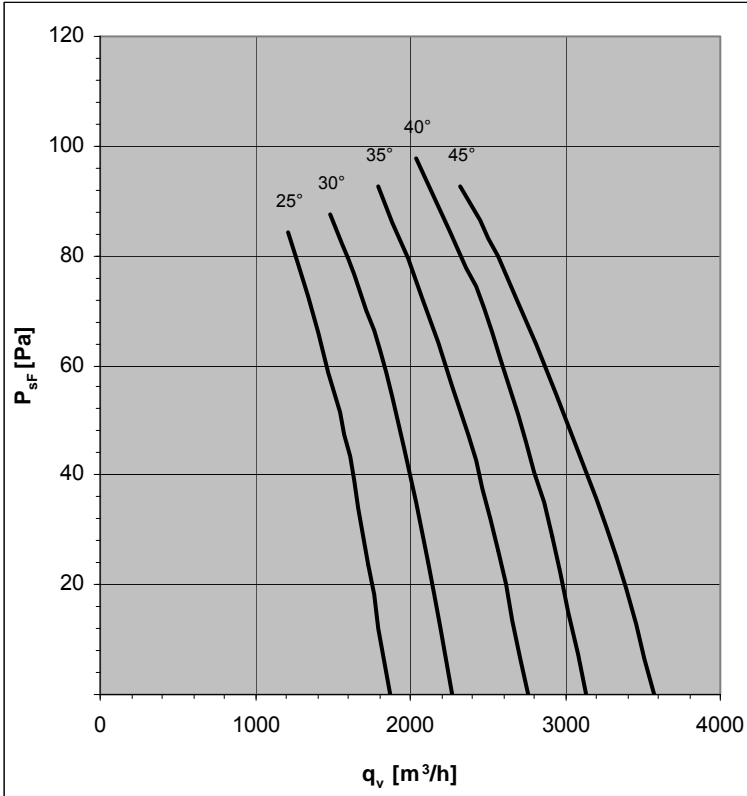

Design K

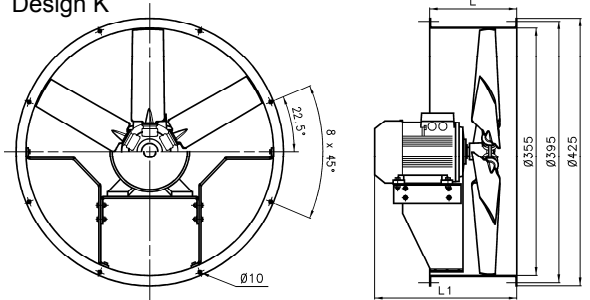

Design F

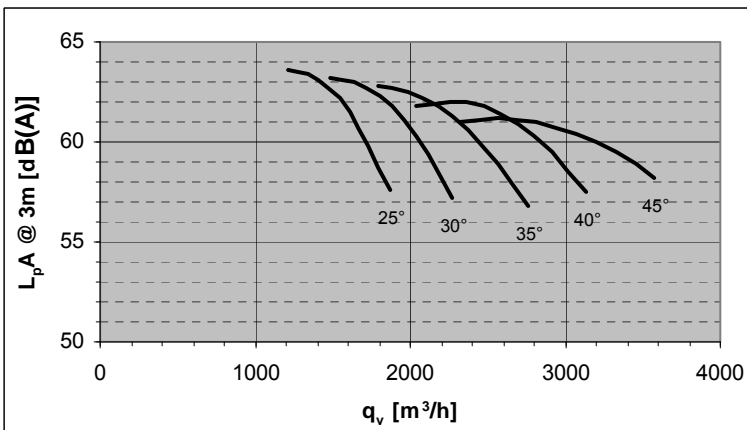
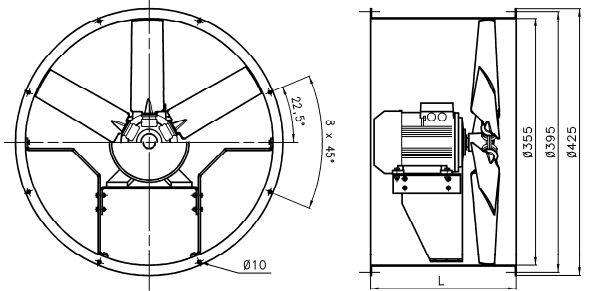

Pitch Angle	Relative spectrum LW dB(A)							
	63	125	250	500	1000	2000	4000	8000
25°	-38	-30	-13	-6	-4	-5	-10	-18
30°	-36	-29	-13	-6	-3	-5	-9	-17
35°	-35	-28	-13	-6	-3	-5	-8	-16
40°	-35	-27	-13	-7	-3	-5	-8	-15
45°	-34	-26	-14	-7	-3	-4	-7	-14

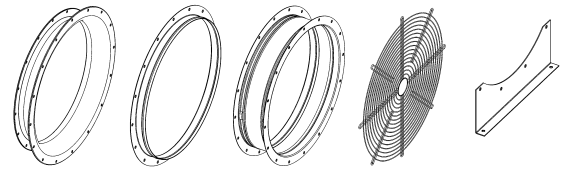

Accessories : see pages 104-106

Design	Pitch Angle	Type (G finish)	Part N°	Type (H finish)	Part N°	L1(mm)	L(mm)	Weight (kg)
K	25°	FV35V-4DK.87.25.G	150104	FV35V-4DK.87.25.H	150105	269	260	14
	30°	FV35V-4DK.87.30.G	150076	FV35V-4DK.87.30.H	150077	269	260	14
	35°	FV35V-4DK.97.35.G	150080	FV35V-4DK.97.35.H	150081	296	260	14
	40°	FV35V-4DK.97.40.G	150108	FV35V-4DK.97.40.H	150109	296	260	15
	45°	FV35V-4DK.97.45.G	150088	FV35V-4DK.97.45.H	150089	296	260	15
F	25°	FV35V-4DF.87.25.G	150106	FV35V-4DF.87.25.H	150107	---	400	17
	30°	FV35V-4DF.87.30.G	150078	FV35V-4DF.87.30.H	150079	---	400	17
	35°	FV35V-4DF.97.35.G	150082	FV35V-4DF.97.35.H	150083	---	400	17
	40°	FV35V-4DF.97.40.G	150110	FV35V-4DF.97.40.H	150111	---	400	18
	45°	FV35V-4DF.97.45.G	150090	FV35V-4DF.97.45.H	150091	---	400	18

FV40V-2D



50Hz Motor	U	I	P ₂	n	
	V	A	kW	min ⁻¹	
25°	80 M	400	2,4	1,1	2870
30°	90 S	400	3,13	1,5	2890
35°	90 L	400	4,49	2,2	2890
40°	90 L	400	4,49	2,2	2890
45°	100 L	400	5,88	3	2890

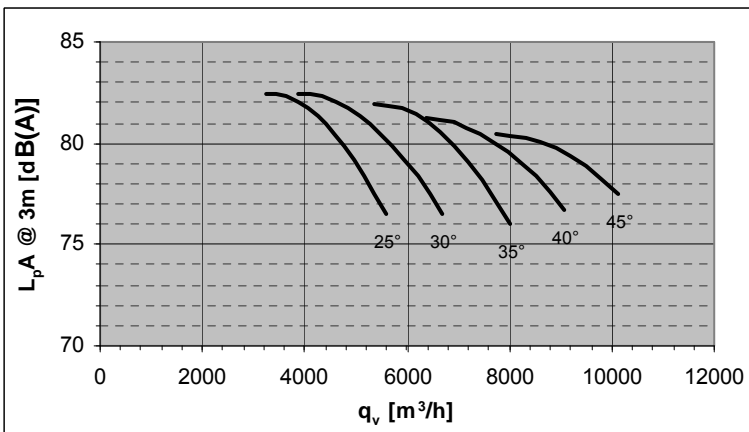
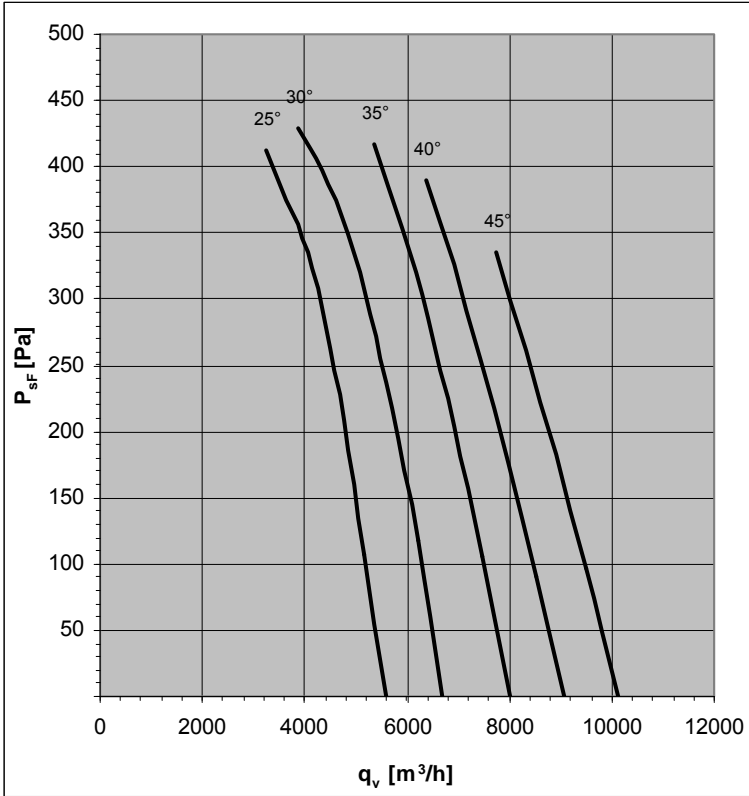

Design K

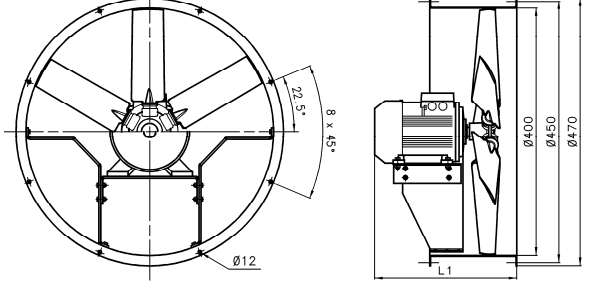

Design F

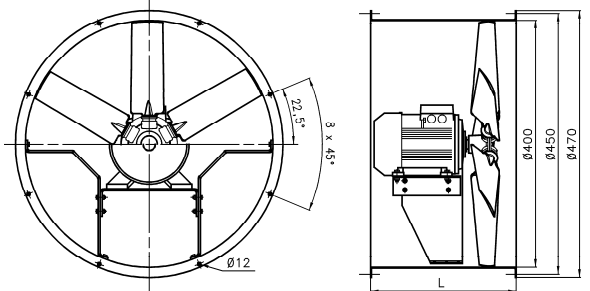

Pitch Angle	Relative spectrum LW dB(A)							
	63	125	250	500	1000	2000	4000	8000
25°	-47	-37	-16	-8	-4	-6	-12	-23
30°	-46	-36	-16	-8	-4	-6	-11	-22
35°	-44	-35	-17	-8	-4	-6	-10	-20
40°	-44	-34	-17	-8	-4	-6	-10	-19
45°	-43	-33	-17	-8	-4	-6	-9	-18

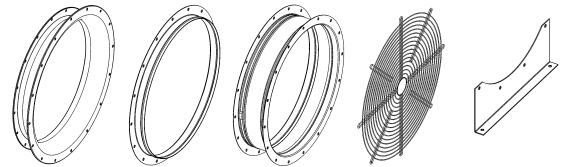

Accessories : see pages 104-106

Design	Pitch Angle	Type (G finish)	Part N°	Type (H finish)	Part N°	L1(mm)	L(mm)	Weight (kg)
K	25°	FV40V-2DK.B7.25.G	150112	FV40V-2DK.B7.25.H	150113	351	260	27
	30°	FV40V-2DK.C7.30.G	150172	FV40V-2DK.C7.30.H	150173	372	260	31
	35°	FV40V-2DK.D7.35.G	150176	FV40V-2DK.D7.35.H	150177	397	260	35
	40°	FV40V-2DK.D7.40.G	150124	FV40V-2DK.D7.40.H	150125	397	260	35
	45°	FV40V-2DK.E7.45.G	150128	FV40V-2DK.E7.45.H	150129	444	260	42
F	25°	FV40V-2DF.B7.25.G	150114	FV40V-2DF.B7.25.H	150115	---	470	31
	30°	FV40V-2DF.C7.30.G	150174	FV40V-2DF.C7.30.H	150175	---	470	35
	35°	FV40V-2DF.D7.35.G	150178	FV40V-2DF.D7.35.H	150179	---	470	40
	40°	FV40V-2DF.D7.40.G	150126	FV40V-2DF.D7.40.H	150127	---	470	40
	45°	FV40V-2DF.E7.45.G	150130	FV40V-2DF.E7.45.H	150131	---	470	47

FV40V-4D



50Hz Motor	U	I	P ₂	n	
	V	A	kW	min ⁻¹	
25°	63 M	400	0,12*	1350	
30°	63 M	400	0,18*	1350	
35°	63 M	400	0,18*	1350	
40°	71 M	400	0,25*	1350	
45°	71 M	400	1,06	0,37*	1370

*out of IE2 standard scope

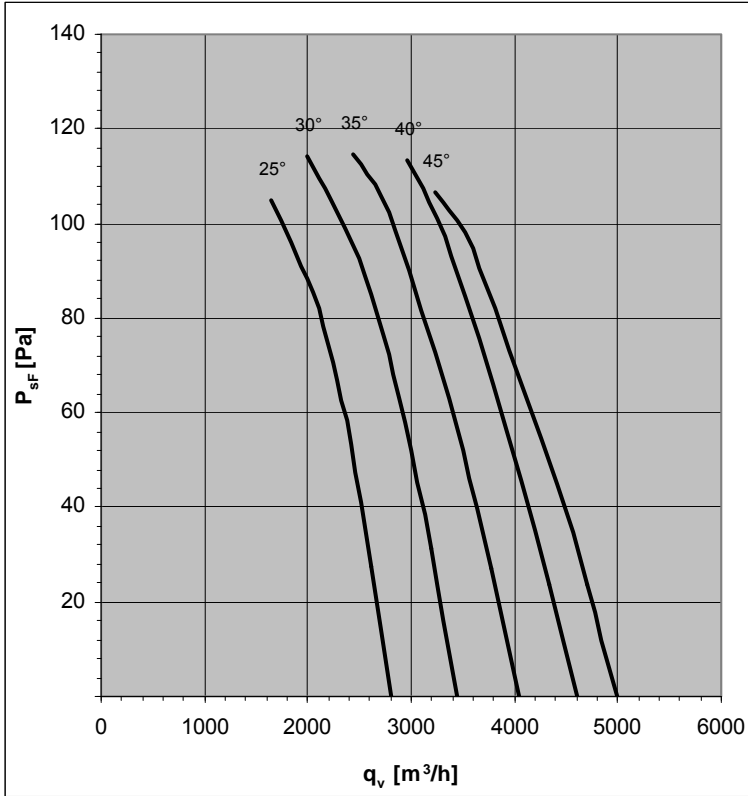

Design K

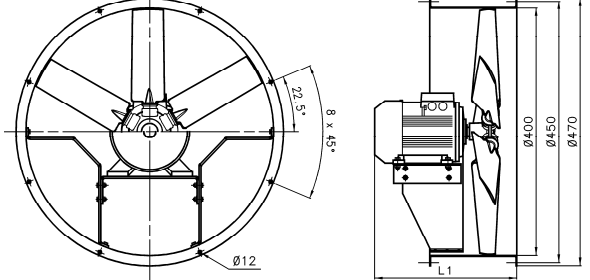

Design F

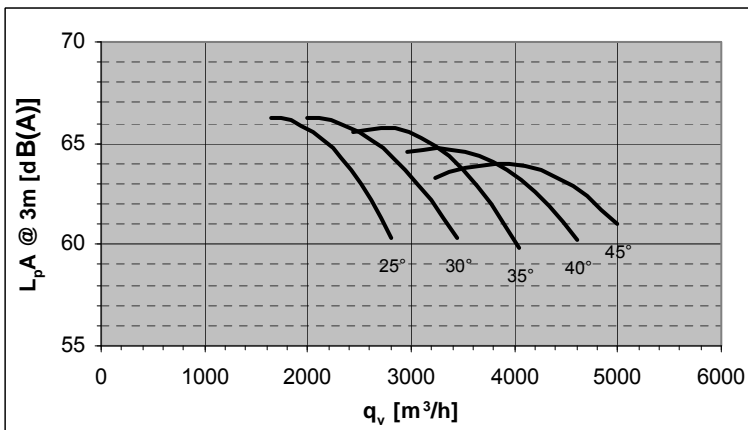
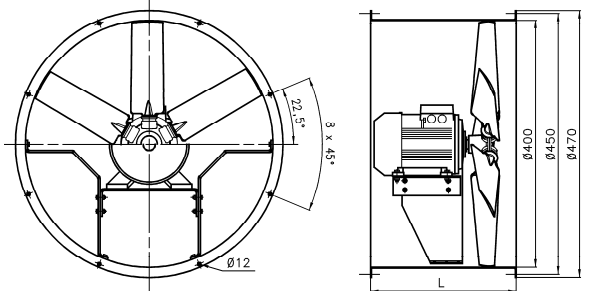

Pitch Angle	Relative spectrum LW dB(A)							
	63	125	250	500	1000	2000	4000	8000
25°	-39	-31	-13	-7	-4	-5	-10	-19
30°	-38	-30	-14	-7	-4	-5	-9	-18
35°	-37	-29	-14	-7	-4	-5	-9	-17
40°	-36	-28	-14	-7	-4	-5	-8	-16
45°	-35	-27	-14	-7	-4	-5	-8	-15

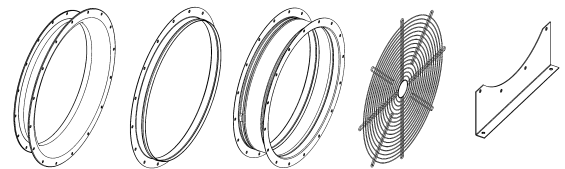

Accessories : see pages 104-106

Design	Pitch Angle	Type (G finish)	Part N°	Type (H finish)	Part N°	L1(mm)	L(mm)	Weight (kg)
K	25°	FV40V-4DK.97.25.G	150180	FV40V-4DK.97.25.H	150181	296	260	16
	30°	FV40V-4DK.97.30.G	150184	FV40V-4DK.97.30.H	150185	296	260	16
	35°	FV40V-4DK.97.35.G	150140	FV40V-4DK.97.35.H	150141	296	260	16
	40°	FV40V-4DK.A7.40.G	150144	FV40V-4DK.A7.40.H	150145	304	260	18
	45°	FV40V-4DK.A7.45.G	150188	FV40V-4DK.A7.45.H	150189	304	260	19
F	25°	FV40V-4DF.97.25.G	150182	FV40V-4DF.97.25.H	150183	---	470	20
	30°	FV40V-4DF.97.30.G	150186	FV40V-4DF.97.30.H	150187	---	470	21
	35°	FV40V-4DF.97.35.G	150142	FV40V-4DF.97.35.H	150143	---	470	21
	40°	FV40V-4DF.A7.40.G	150146	FV40V-4DF.A7.40.H	150147	---	470	22
	45°	FV40V-4DF.A7.45.G	150190	FV40V-4DF.A7.45.H	150191	---	470	24

Increased Temperature Range : -30°C / +60°C

FV40V-6D



50Hz Motor	U	I	P ₂	n	
	V	A	kW	min ⁻¹	
25°	63 M	400	0,44	0,09*	850
30°	63 M	400	0,44	0,09*	850
35°	63 M	400	0,44	0,09*	850
40°	63 M	400	0,44	0,09*	850
45°	63 M	400	0,44	0,09*	850

*out of IE2 standard scope

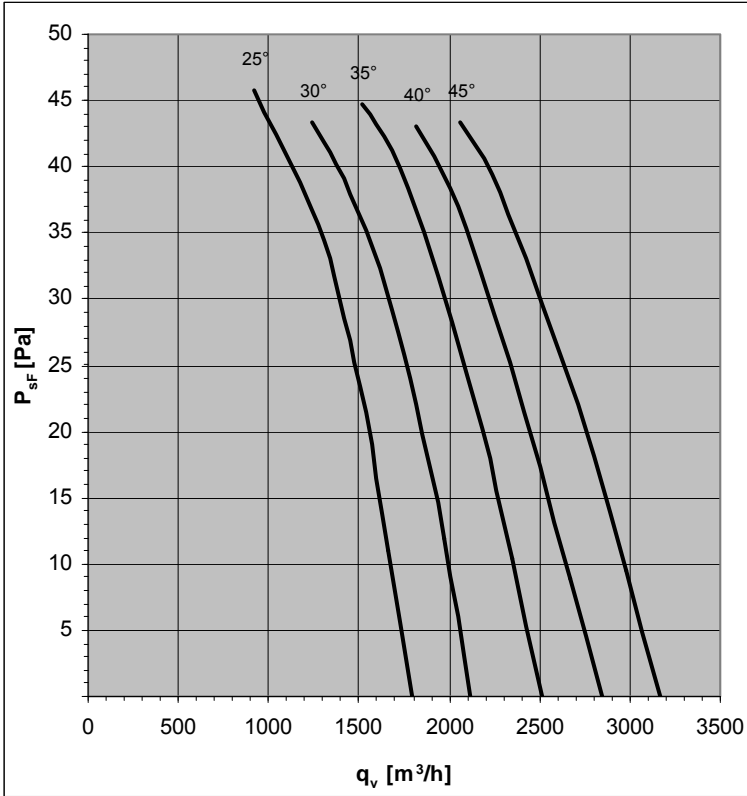

Design K

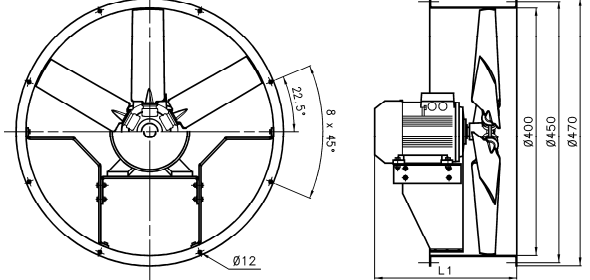

Design F

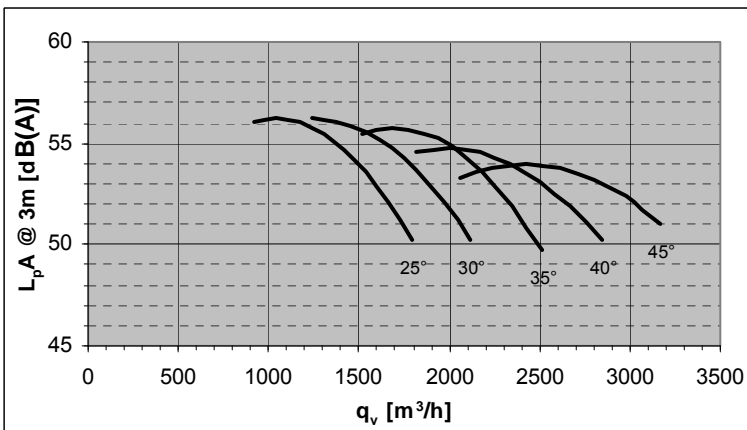
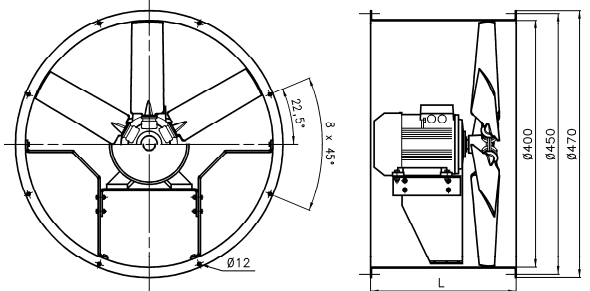

Pitch Angle	Relative spectrum LW dB(A)							
	63	125	250	500	1000	2000	4000	8000
25°	-34	-27	-12	-6	-3	-5	-9	-16
30°	-33	-26	-12	-6	-3	-4	-8	-16
35°	-32	-25	-12	-6	-3	-4	-8	-15
40°	-31	-24	-12	-6	-3	-4	-7	-14
45°	-31	-24	-12	-6	-3	-4	-7	-13

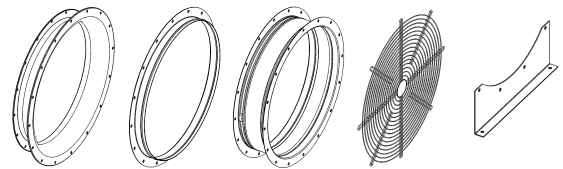

Accessories : see pages 104-106

Design	Pitch Angle	Type (G finish)	Part N°	Type (H finish)	Part N°	L1(mm)	L(mm)	Weight (kg)
K	25°	FV40V-6DK.97.25.G	150152	FV40V-6DK.97.25.H	150153	296	260	16
	30°	FV40V-6DK.97.30.G	150156	FV40V-6DK.97.30.H	150157	296	260	16
	35°	FV40V-6DK.97.35.G	150160	FV40V-6DK.97.35.H	150161	296	260	16
	40°	FV40V-6DK.97.40.G	150164	FV40V-6DK.97.40.H	150165	296	260	16
	45°	FV40V-6DK.97.45.G	150168	FV40V-6DK.97.45.H	150169	296	260	16
F	25°	FV40V-6DF.97.25.G	150154	FV40V-6DF.97.25.H	150155	---	470	21
	30°	FV40V-6DF.97.30.G	150158	FV40V-6DF.97.30.H	150159	---	470	21
	35°	FV40V-6DF.97.35.G	150162	FV40V-6DF.97.35.H	150163	---	470	21
	40°	FV40V-6DF.97.40.G	150166	FV40V-6DF.97.40.H	150167	---	470	21
	45°	FV40V-6DF.97.45.G	150170	FV40V-6DF.97.45.H	150171	---	470	21

FV45V-2D



50Hz Motor	U	I	P ₂	n	
	V	A	kW	min ⁻¹	
25°	90 L	400	4,49	2,2	2890
30°	90 L	400	4,49	2,2	2890
35°	112 M	400	7,65	4	2900
40°	112 M	400	7,65	4	2900
45°	112 M	400	10,3	5,5	2950

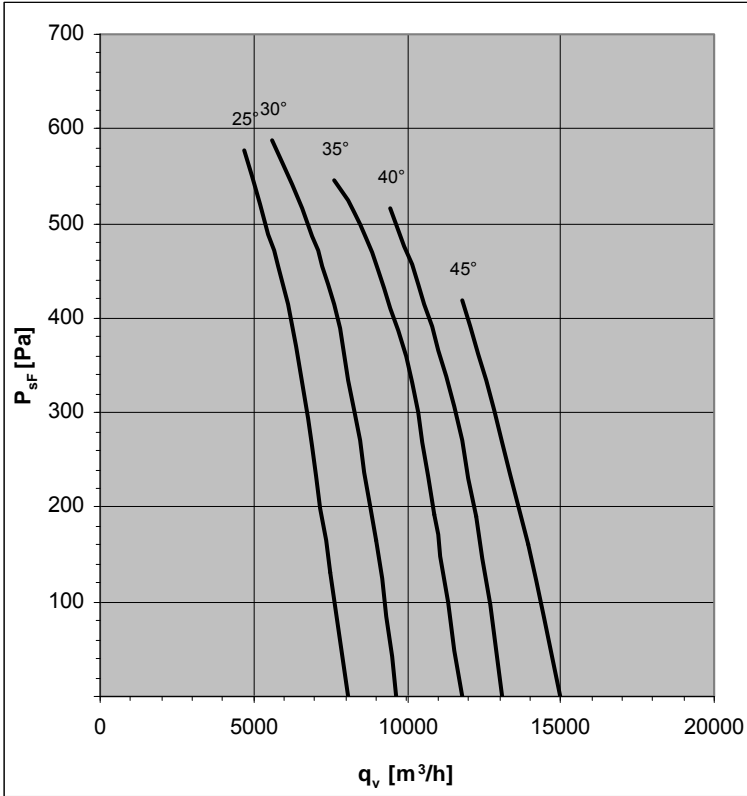

Design K

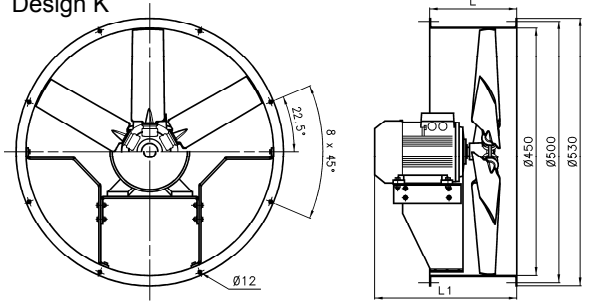

Design F

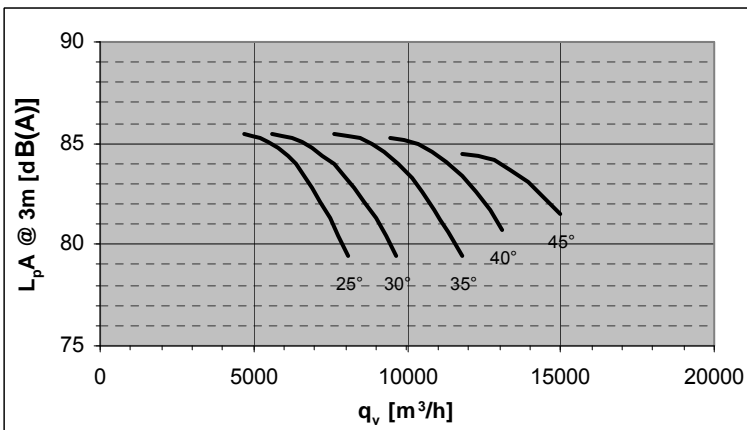
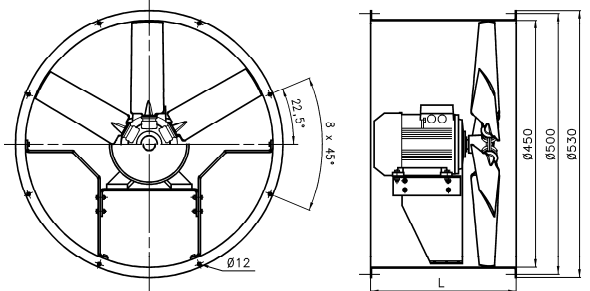

Pitch Angle	Relative spectrum LW dB(A)							
	63	125	250	500	1000	2000	4000	8000
25°	-49	-38	-17	-8	-5	-7	-12	-23
30°	-47	-37	-17	-8	-5	-6	-12	-22
35°	-46	-36	-17	-8	-4	-6	-11	-21
40°	-45	-35	-18	-9	-5	-6	-10	-20
45°	-45	-34	-18	-9	-5	-6	-10	-19

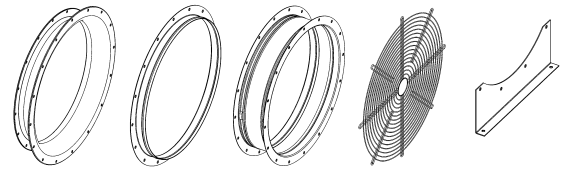

Accessories : see pages 104-106

Design	Pitch Angle	Type (G finish)	Part N°	Type (H finish)	Part N°	L1(mm)	L(mm)	Weight (kg)
K	25°	FV45V-2DK.D7.25.G	150192	FV45V-2DK.D7.25.H	150193	402	260	38
	30°	FV45V-2DK.D7.30.G	150196	FV45V-2DK.D7.30.H	150197	402	260	38
	35°	FV45V-2DK.F7.35.G	150252	FV45V-2DK.F7.35.H	150253	467	385	56
	40°	FV45V-2DK.F7.40.G	150204	FV45V-2DK.F7.40.H	150205	467	385	56
	45°	FV45V-2DK.F7.45.G	150208	FV45V-2DK.F7.45.H	150209	541	385	71
F	25°	FV45V-2DF.D7.25.G	150194	FV45V-2DF.D7.25.H	150195	---	470	43
	30°	FV45V-2DF.D7.30.G	150198	FV45V-2DF.D7.30.H	150199	---	470	43
	35°	FV45V-2DF.F7.35.G	150254	FV45V-2DF.F7.35.H	150255	---	530	60
	40°	FV45V-2DF.F7.40.G	150206	FV45V-2DF.F7.40.H	150207	---	530	60
	45°	FV45V-2DF.F7.45.G	150210	FV45V-2DF.F7.45.H	150211	---	530	75

FV45V-4D



50Hz Motor	U	I	P ₂	n
	V	A	kW	min ⁻¹
25°	63 M	400	0,18*	1350
30°	71 M	400	0,77*	1350
35°	71 M	400	1,06*	1370
40°	80 M	400	1,46*	1395
45°	80 M	400	1,46*	1395

*out of IE2 standard scope

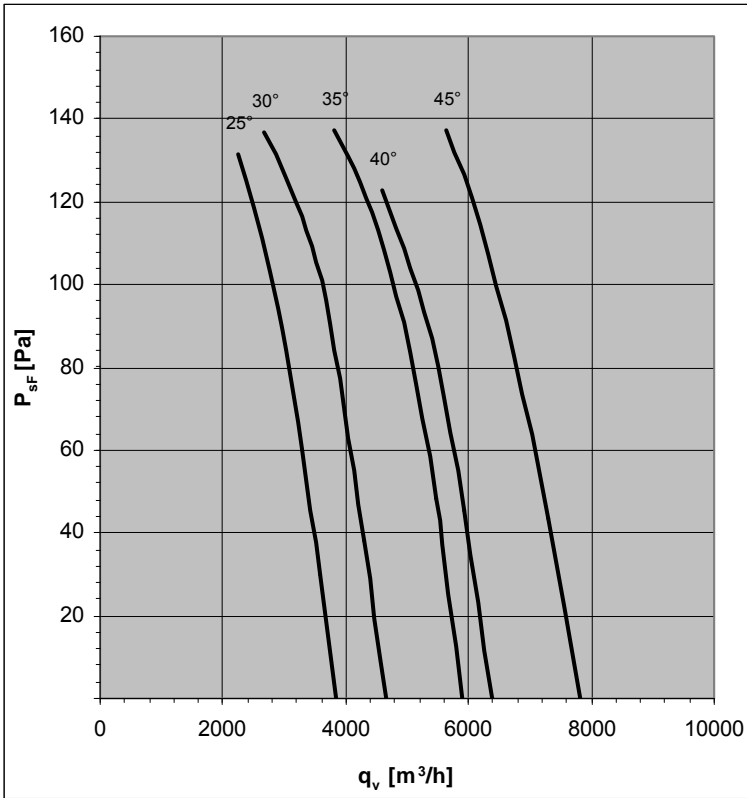

Design K

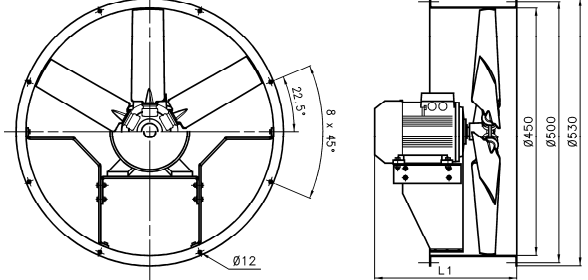

Design F

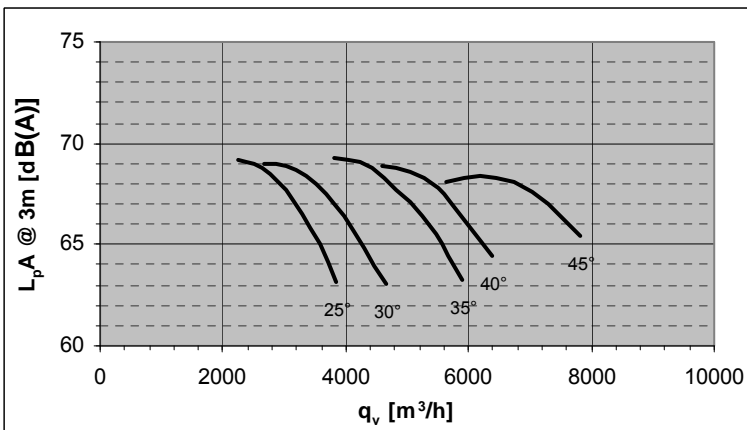
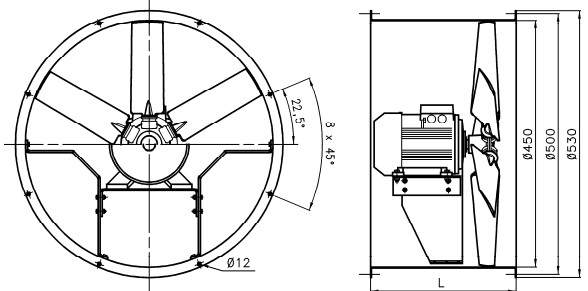

Pitch Angle	Relative spectrum LW dB(A)							
	63	125	250	500	1000	2000	4000	8000
25°	-40	-32	-14	-7	-4	-6	-10	-20
30°	-39	-31	-14	-7	-4	-5	-10	-18
35°	-38	-30	-14	-7	-4	-5	-9	-17
40°	-38	-29	-15	-7	-4	-5	-9	-17
45°	-37	-29	-15	-7	-4	-5	-8	-16

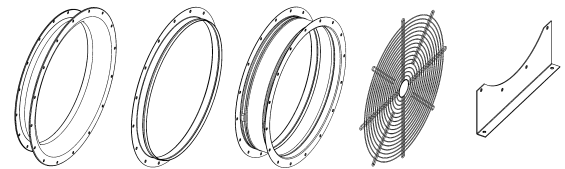

Accessories : see pages 104-106

Design	Pitch Angle	Type (G finish)	Part N°	Type (H finish)	Part N°	L1(mm)	L(mm)	Weight (kg)
K	25°	FV45V-4DK.97.25.G	150212	FV45V-4DK.97.25.H	150213	298	260	20
	30°	FV45V-4DK.A7.30.G	150216	FV45V-4DK.A7.30.H	150217	309	260	21
	35°	FV45V-4DK.A7.35.G	150220	FV45V-4DK.A7.35.H	150221	309	260	22
	40°	FV45V-4DK.B7.40.G	150256	FV45V-4DK.B7.40.H	150257	343	260	25
	45°	FV45V-4DK.B7.45.G	150228	FV45V-4DK.B7.45.H	150229	343	260	25
F	25°	FV45V-4DF.97.25.G	150214	FV45V-4DF.97.25.H	150215	---	470	25
	30°	FV45V-4DF.A7.30.G	150218	FV45V-4DF.A7.30.H	150219	---	470	26
	35°	FV45V-4DF.A7.35.G	150222	FV45V-4DF.A7.35.H	150223	---	470	27
	40°	FV45V-4DF.B7.40.G	150258	FV45V-4DF.B7.40.H	150259	---	470	30
	45°	FV45V-4DF.B7.45.G	150230	FV45V-4DF.B7.45.H	150231	---	470	30

FV45V-6D



50Hz Motor	U	I	P ₂	n	
	V	A	kW	min ⁻¹	
25°	63 M	400	0,44	0,09*	850
30°	63 M	400	0,44	0,09*	850
35°	63 M	400	0,44	0,09*	850
40°	71 M	400	0,72	0,18*	850
45°	71 M	400	0,72	0,18*	850

*out of IE2 standard scope

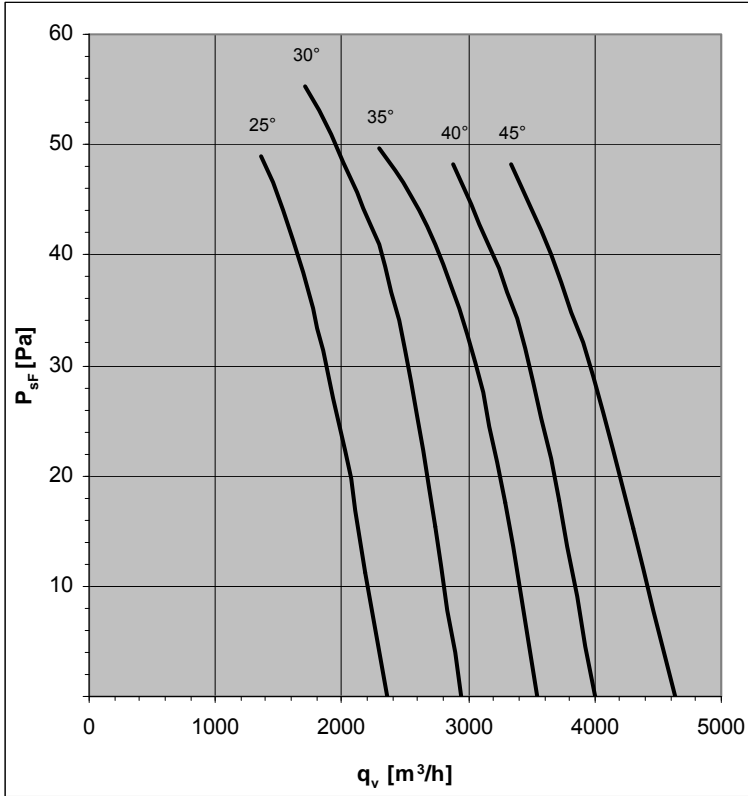

Design K

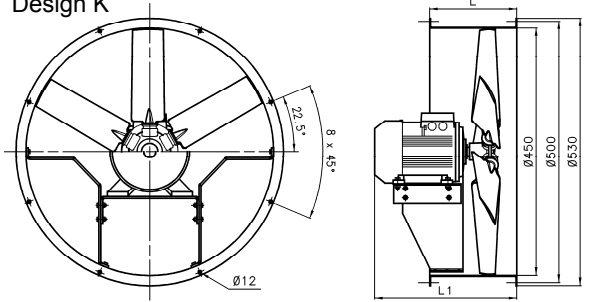

Design F

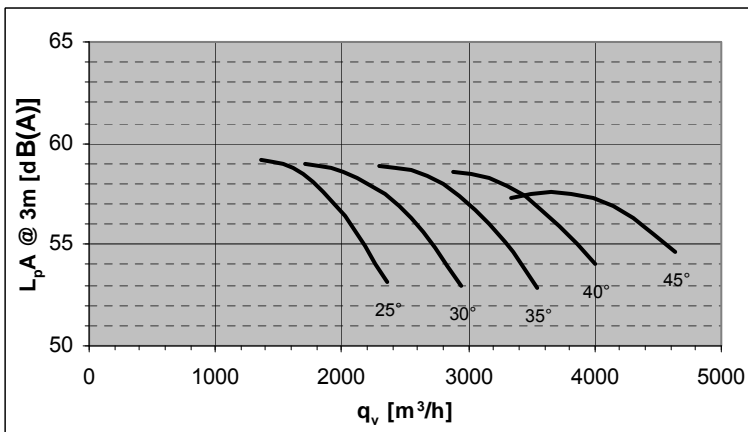
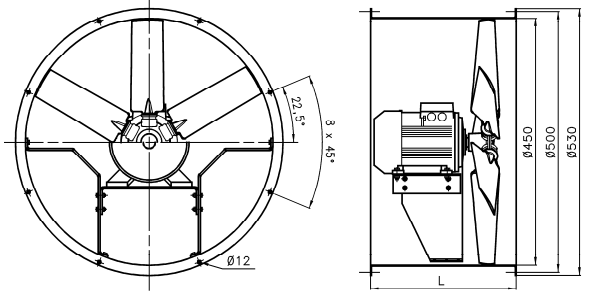

Pitch Angle	Relative spectrum LW dB(A)							
	63	125	250	500	1000	2000	4000	8000
25°	-35	-28	-12	-6	-3	-5	-9	-17
30°	-34	-27	-12	-6	-3	-5	-8	-16
35°	-33	-26	-12	-6	-3	-4	-8	-15
40°	-33	-26	-13	-6	-3	-4	-7	-15
45°	-32	-25	-13	-6	-3	-4	-7	-14

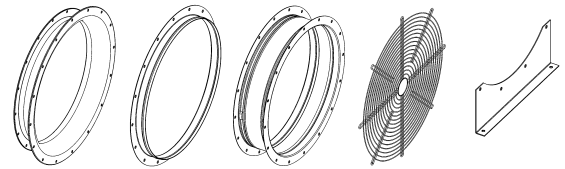

Accessories : see pages 104-106

Design	Pitch Angle	Type (G finish)	Part N°	Type (H finish)	Part N°	L1(mm)	L(mm)	Weight (kg)
K	25°	FV45V-6DK.97.25.G	150232	FV45V-6DK.97.25.H	150233	298	260	20
	30°	FV45V-6DK.97.30.G	150236	FV45V-6DK.97.30.H	150237	298	260	20
	35°	FV45V-6DK.97.35.G	150240	FV45V-6DK.97.35.H	150241	298	260	20
	40°	FV45V-6DK.A7.40.G	150260	FV45V-6DK.A7.40.H	150261	309	260	21
	45°	FV45V-6DK.A7.45.G	150248	FV45V-6DK.A7.45.H	150249	309	260	21
F	25°	FV45V-6DF.97.25.G	150234	FV45V-6DF.97.25.H	150235	---	470	25
	30°	FV45V-6DF.97.30.G	150238	FV45V-6DF.97.30.H	150239	---	470	25
	35°	FV45V-6DF.97.35.G	150242	FV45V-6DF.97.35.H	150243	---	470	25
	40°	FV45V-6DF.A7.40.G	150262	FV45V-6DF.A7.40.H	150263	---	470	26
	45°	FV45V-6DF.A7.45.G	150250	FV45V-6DF.A7.45.H	150251	---	470	26

Increased Temperature Range : -30°C / +60°C

FV50V-2D



50Hz Motor	U	I	P ₂	n	
	V	A	kW	min ⁻¹	
25°	100 L	400	5,88	3	2890
30°	112 M	400	7,65	4	2900
35°	132 S	400	10,4	5,5	2930
40°	132 S	400	14	7,5	2930
45°	132 S	400	14	7,5	2930

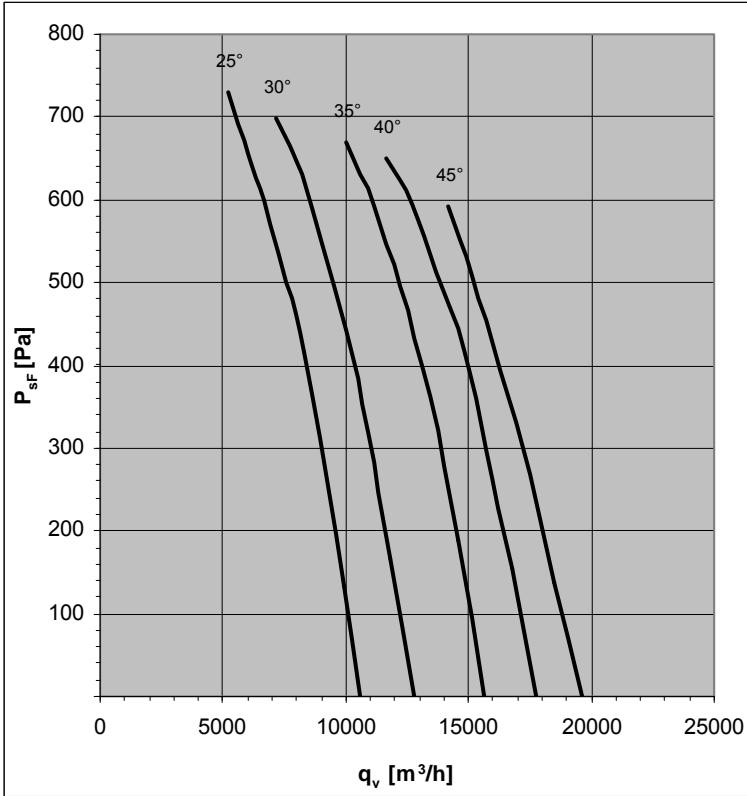

Design K

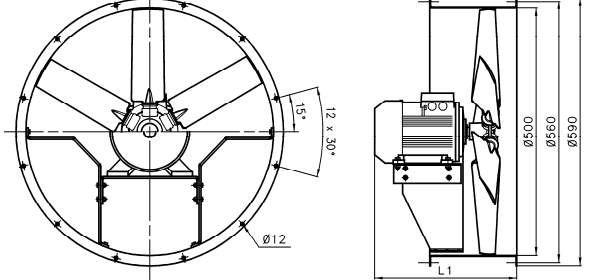

Design F

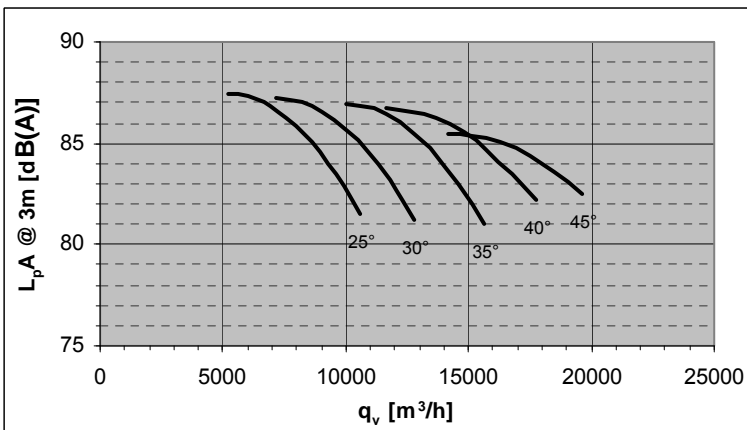
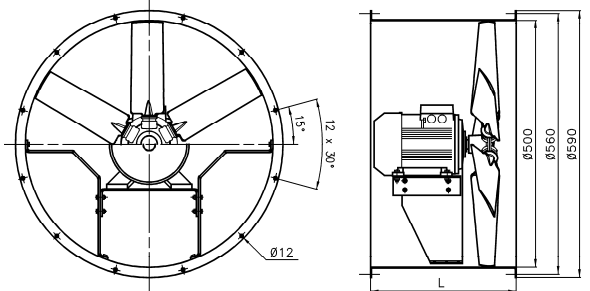

Pitch Angle	Relative spectrum LW dB(A)							
	63	125	250	500	1000	2000	4000	8000
25°	-50	-39	-17	-8	-5	-7	-13	-24
30°	-48	-38	-17	-8	-5	-7	-12	-23
35°	-47	-37	-17	-9	-5	-6	-11	-21
40°	-46	-36	-18	-9	-5	-6	-10	-20
45°	-45	-35	-18	-9	-5	-6	-10	-19

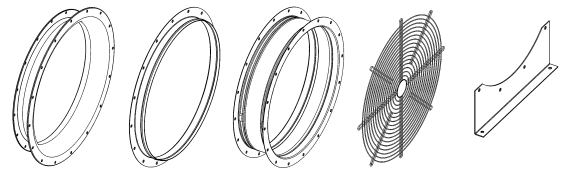

Accessories : see pages 104-106

Design	Pitch Angle	Type (G finish)	Part N°	Type (H finish)	Part N°	L1(mm)	L(mm)	Weight (kg)
K	25°	FV50V-2DK.E7.25.G	150325	FV50V-2DK.E7.25.H	150326	449	260	47
	30°	FV50V-2DK.F7.30.G	150329	FV50V-2DK.F7.30.H	150330	467	385	58
	35°	FV50V-2DK.G7.35.G	150273	FV50V-2DK.G7.35.H	150274	541	385	73
	40°	FV50V-2DK.G7.40.G	150333	FV50V-2DK.G7.40.H	150334	541	385	79
	45°	FV50V-2DK.G7.45.G	150281	FV50V-2DK.G7.45.H	150282	541	385	79
F	25°	FV50V-2DF.E7.25.G	150327	FV50V-2DF.E7.25.H	150328	---	470	52
	30°	FV50V-2DF.F7.30.G	150331	FV50V-2DF.F7.30.H	150332	---	540	62
	35°	FV50V-2DF.G7.35.G	150275	FV50V-2DF.G7.35.H	150276	---	540	78
	40°	FV50V-2DF.G7.40.G	150335	FV50V-2DF.G7.40.H	150336	---	540	83
	45°	FV50V-2DF.G7.45.G	150283	FV50V-2DF.G7.45.H	150284	---	540	83

FV50V-4D



50Hz Motor	U	I	P ₂	n	
	V	A	kW	min ⁻¹	
25°	71 M	400	0,77	0,25*	1350
30°	71 M	400	1,06	0,37*	1370
35°	80 M	400	1,46	0,55*	1395
40°	80 M	400	1,81	0,75	1400
45°	90 S	400	2,53	1,1	1430

*out of IE2 standard scope

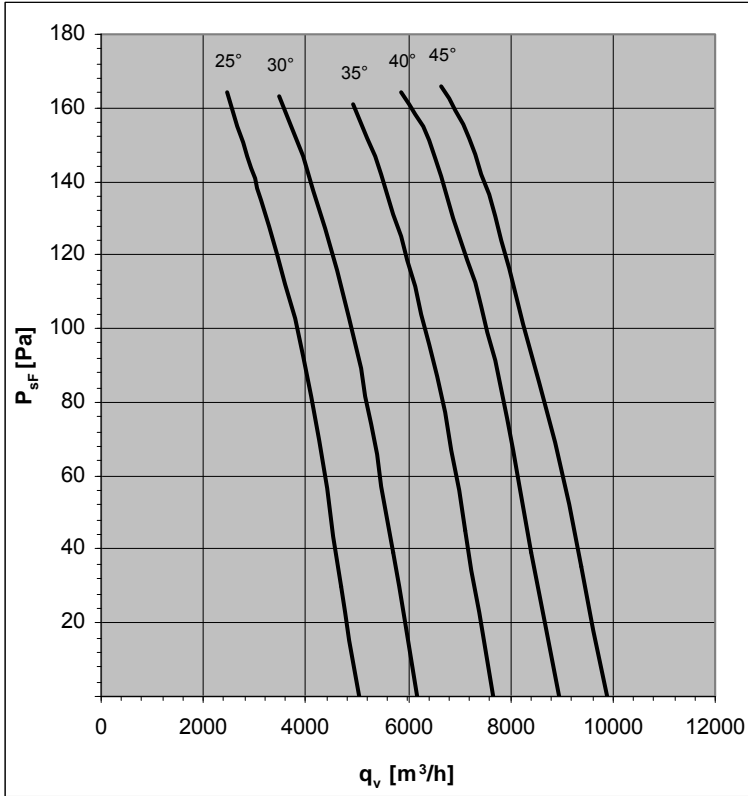

Design K

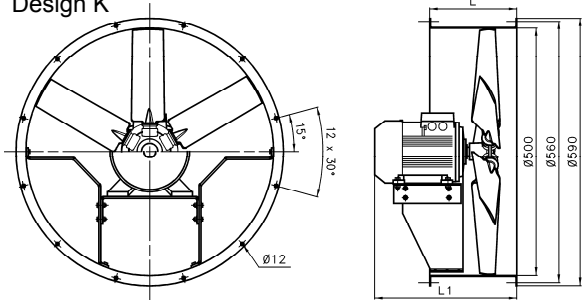

Design F

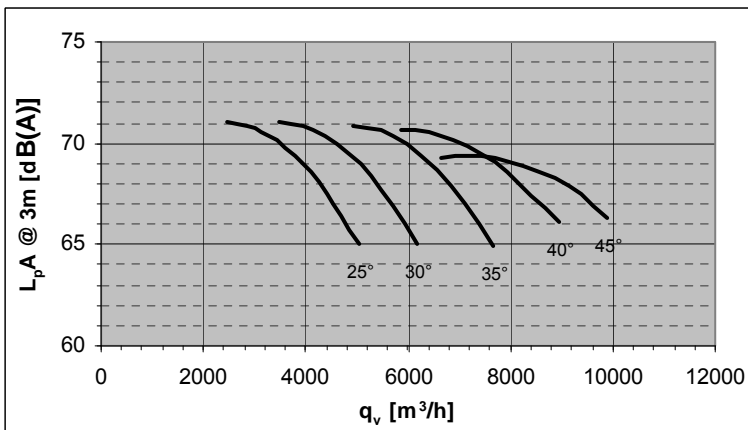
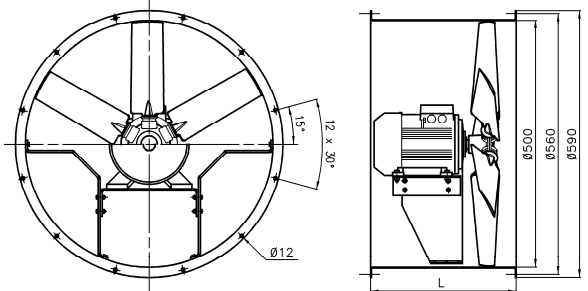

Pitch Angle	Relative spectrum LW dB(A)							
	63	125	250	500	1000	2000	4000	8000
25°	-41	-33	-14	-7	-4	-6	-11	-20
30°	-40	-32	-14	-7	-4	-5	-10	-19
35°	-39	-31	-15	-7	-4	-5	-9	-18
40°	-39	-30	-15	-7	-4	-5	-9	-17
45°	-38	-29	-15	-7	-4	-5	-8	-16

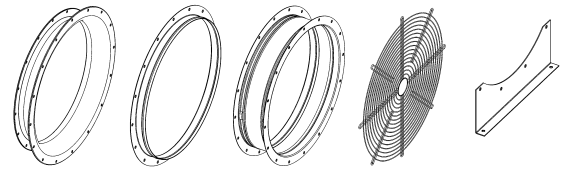

Accessories : see pages 104-106

Design	Pitch Angle	Type (G finish)	Part N°	Type (H finish)	Part N°	L1(mm)	L(mm)	Weight (kg)
K	25°	FV50V-4DK.A7.25.G	150285	FV50V-4DK.A7.25.H	150286	309	260	23
	30°	FV50V-4DK.A7.30.G	150289	FV50V-4DK.A7.30.H	150290	309	260	24
	35°	FV50V-4DK.B7.35.G	150293	FV50V-4DK.B7.35.H	150294	343	260	27
	40°	FV50V-4DK.B7.40.G	150297	FV50V-4DK.B7.40.H	150298	379	260	30
	45°	FV50V-4DK.C7.45.G	150337	FV50V-4DK.C7.45.H	150338	377	260	36
F	25°	FV50V-4DF.A7.25.G	150287	FV50V-4DF.A7.25.H	150288	---	470	28
	30°	FV50V-4DF.A7.30.G	150291	FV50V-4DF.A7.30.H	150292	---	470	29
	35°	FV50V-4DF.B7.35.G	150295	FV50V-4DF.B7.35.H	150296	---	470	32
	40°	FV50V-4DF.B7.40.G	150299	FV50V-4DF.B7.40.H	150300	---	470	36
	45°	FV50V-4DF.C7.45.G	150339	FV50V-4DF.C7.45.H	150340	---	470	42

FV50V-6D



50Hz Motor	U	I	P ₂	n	
	V	A	kW	min ⁻¹	
25°	63 M	400	0,44	0,09*	850
30°	63 M	400	0,44	0,09*	850
35°	71 M	400	0,72	0,18*	850
40°	71 M	400	0,72	0,18*	850
45°	71 M	400	0,72	0,18*	850

*out of IE2 standard scope

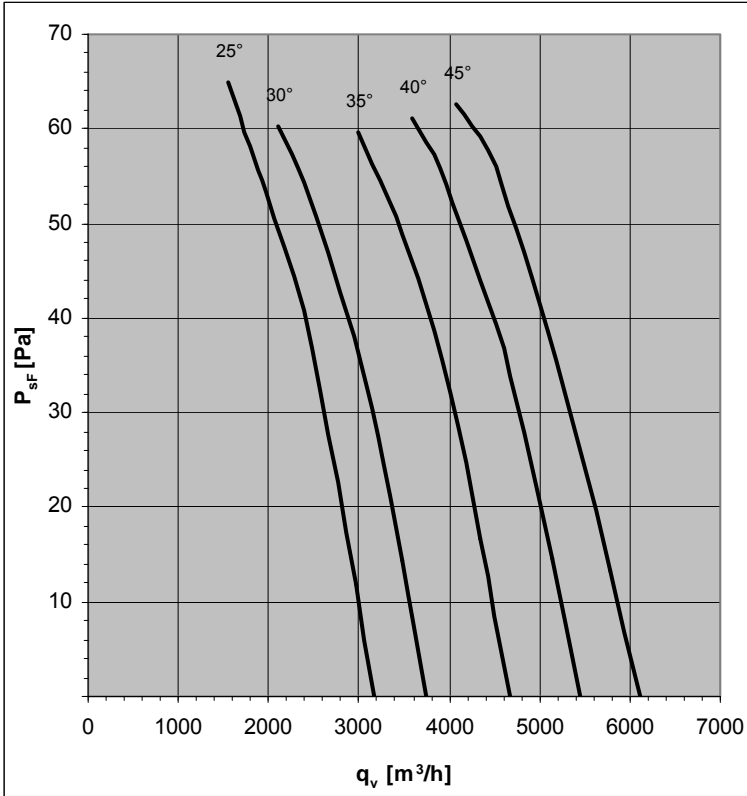

Design K

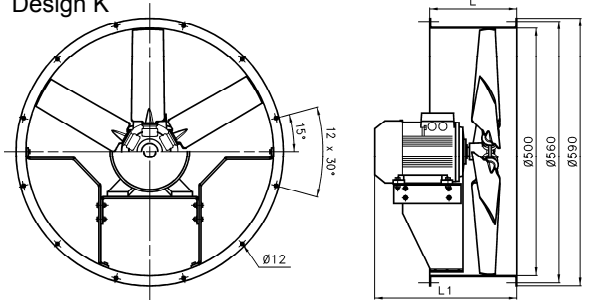

Design F

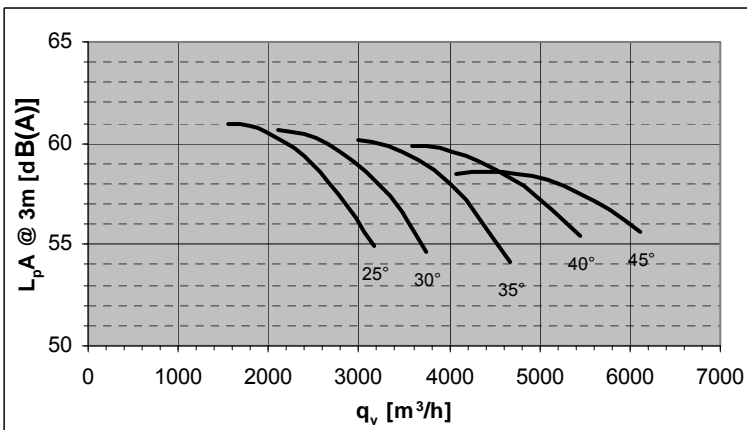
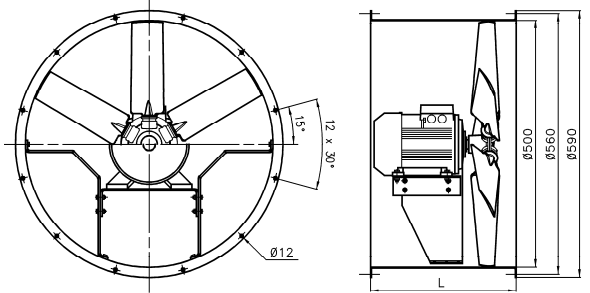

Pitch Angle	Relative spectrum LW dB(A)							
	63	125	250	500	1000	2000	4000	8000
25°	-36	-29	-13	-6	-3	-5	-9	-18
30°	-35	-28	-13	-6	-3	-5	-9	-17
35°	-34	-27	-13	-6	-3	-5	-8	-16
40°	-34	-26	-13	-6	-3	-4	-8	-15
45°	-33	-25	-13	-6	-3	-4	-7	-14

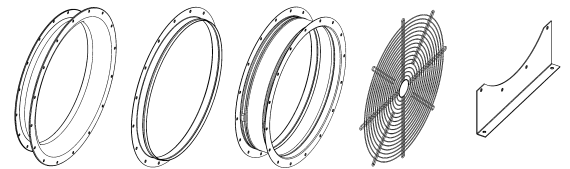

Accessories : see pages 104-106

Design	Pitch Angle	Type (G finish)	Part N°	Type (H finish)	Part N°	L1(mm)	L(mm)	Weight (kg)
K	25°	FV50V-6DK.97.25.G	150305	FV50V-6DK.97.25.H	150306	298	260	22
	30°	FV50V-6DK.97.30.G	150309	FV50V-6DK.97.30.H	150310	298	260	22
	35°	FV50V-6DK.A7.35.G	150313	FV50V-6DK.A7.35.H	150314	309	260	23
	40°	FV50V-6DK.A7.40.G	150317	FV50V-6DK.A7.40.H	150318	309	260	23
	45°	FV50V-6DK.A7.45.G	150321	FV50V-6DK.A7.45.H	150322	309	260	23
F	25°	FV50V-6DF.97.25.G	150307	FV50V-6DF.97.25.H	150308	---	470	28
	30°	FV50V-6DF.97.30.G	150311	FV50V-6DF.97.30.H	150312	---	470	28
	35°	FV50V-6DF.A7.35.G	150315	FV50V-6DF.A7.35.H	150316	---	470	28
	40°	FV50V-6DF.A7.40.G	150319	FV50V-6DF.A7.40.H	150320	---	470	28
	45°	FV50V-6DF.A7.45.G	150323	FV50V-6DF.A7.45.H	150324	---	470	28

FV56V-2D



50Hz Motor	U	I	P ₂	n	
	V	A	kW	min ⁻¹	
25°	112 M	400	7,65	4	2900
30°	132 S	400	10,4	5,5	2930
35°	132 S	400	14	7,5	2930
-	-	400	-	-	-
400					

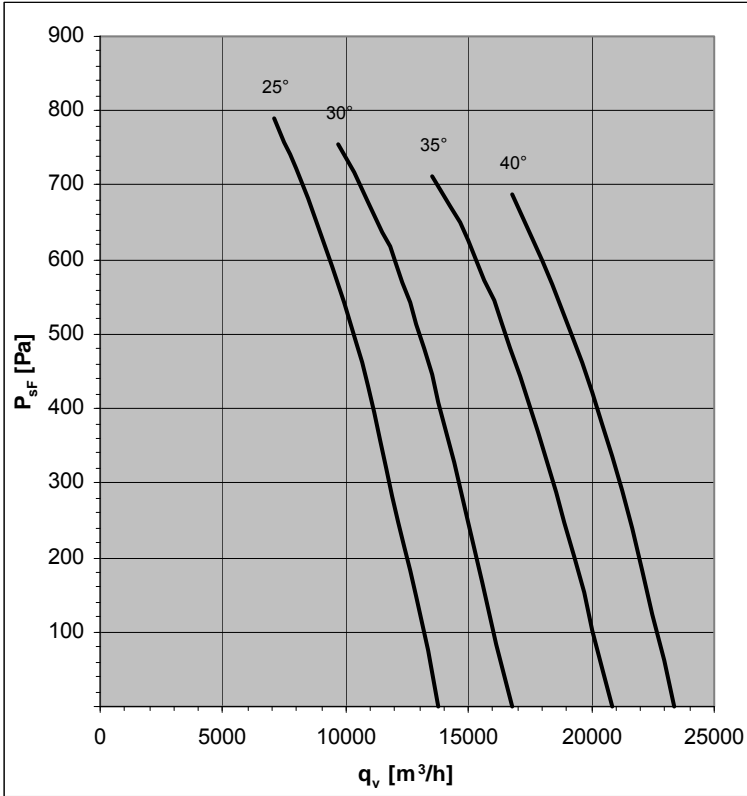

Design K

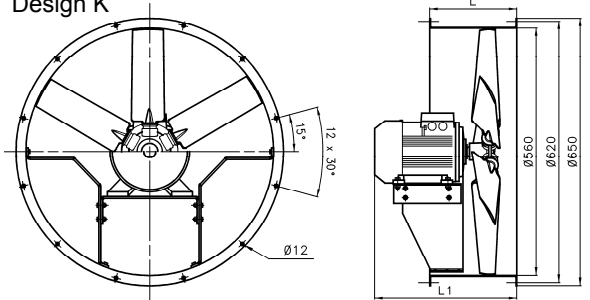

Design F

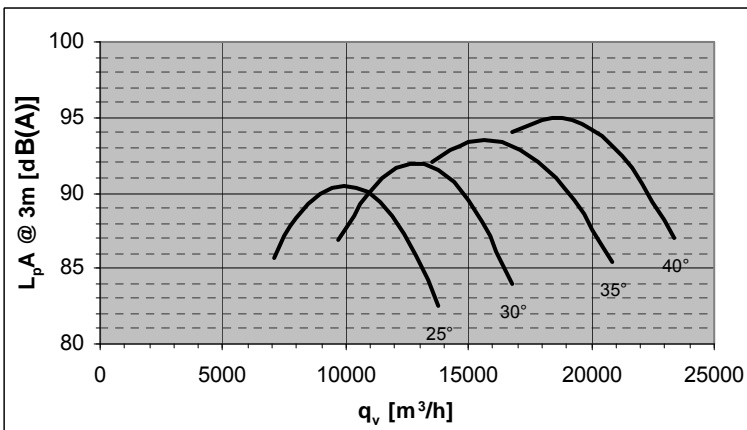
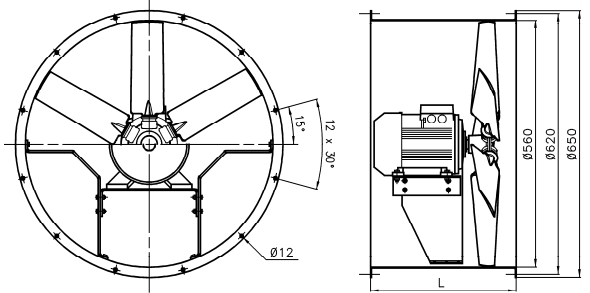

Pitch Angle	Relative spectrum LW dB(A)							
	63	125	250	500	1000	2000	4000	8000
25°	-50	-40	-17	-8	-5	-7	-13	-24
30°	-49	-39	-18	-9	-5	-7	-12	-23
35°	-49	-38	-18	-9	-5	-7	-12	-22
40°	-48	-38	-19	-9	-5	-6	-11	-21

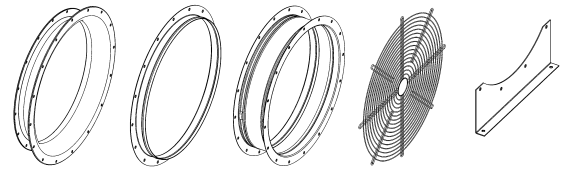

Accessories : see pages 104-106

Design	Pitch Angle	Type (G finish)	Part N°	Type (H finish)	Part N°	L1(mm)	L(mm)	Weight (kg)
K	25°	FV56V-2DK.F7.25.G	151018	FV56V-2DK.F7.25.H	151019	467	385	62
	30°	FV56V-2DK.G7.30.G	151022	FV56V-2DK.G7.30.H	151023	541	385	77
	35°	FV56V-2DK.G7.35.G	151026	FV56V-2DK.G7.35.H	151027	541	385	83
	-	-	-	-	-	---	---	---
F	25°	FV56V-2DF.F7.25.G	151020	FV56V-2DF.F7.25.H	151021	---	540	67
	30°	FV56V-2DF.G7.30.G	151024	FV56V-2DF.G7.30.H	151025	---	540	82
	35°	FV56V-2DF.G7.35.G	151028	FV56V-2DF.G7.35.H	151029	---	540	88
	-	-	-	-	-	---	---	---

Increased Temperature Range : -30°C / +60°C

FV56V-4D



50Hz Motor	U	I	P ₂	n	
	V	A	kW	min ⁻¹	
30°	80 M	400	1,46	0,55*	1395
35°	80 M	400	1,81	0,75	1400
40°	90 S	400	2,53	1,1	1430
45°	90 L	400	3,31	1,5	1430
50°	90 L	400	3,31	1,5	1430

*out of IE2 standard scope

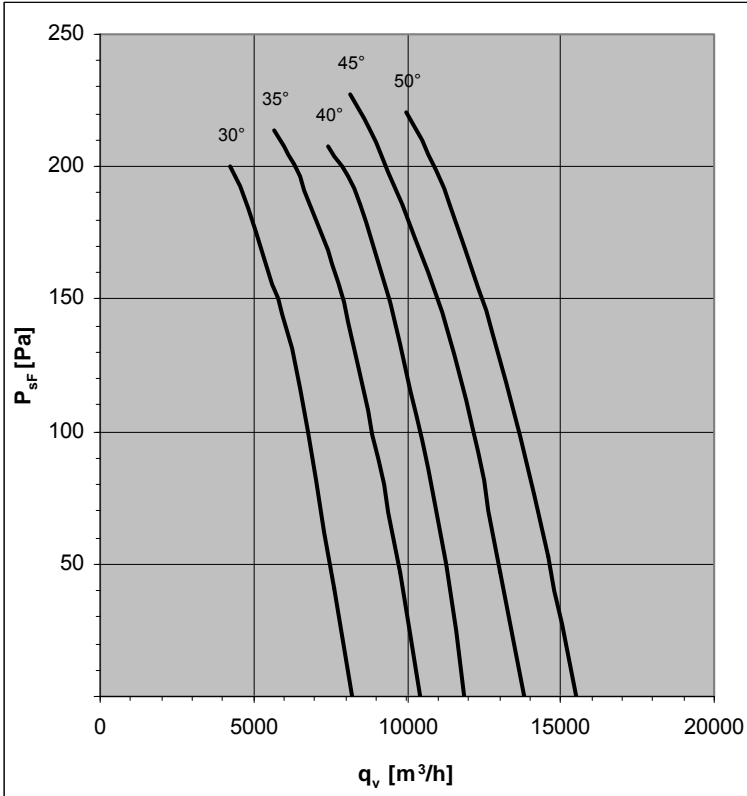

Design K

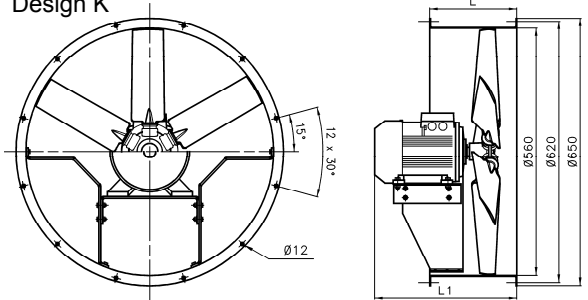

Design F

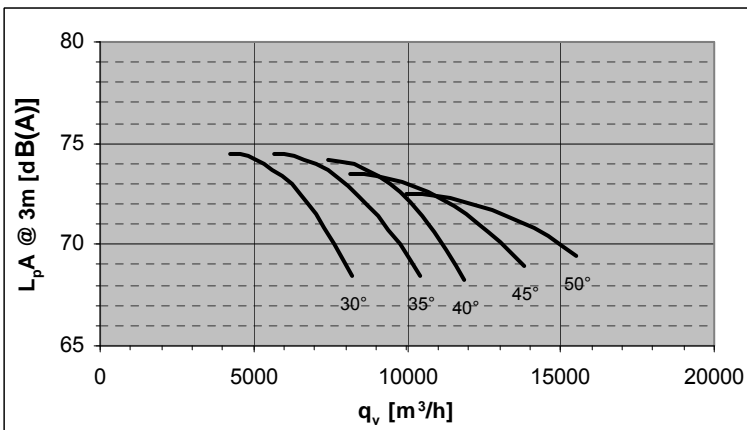
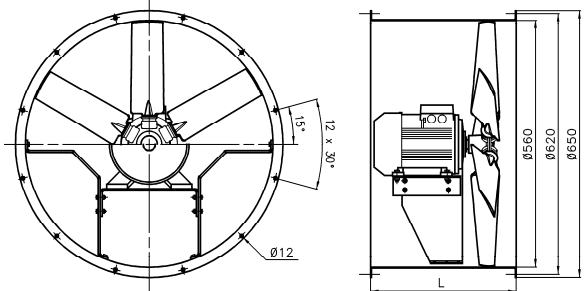

Pitch Angle	Relative spectrum LW dB(A)							
	63	125	250	500	1000	2000	4000	8000
30°	-43	-34	-15	-7	-4	-6	-11	-21
35°	-42	-33	-15	-7	-4	-6	-10	-20
40°	-41	-32	-15	-7	-4	-5	-10	-19
45°	-40	-31	-15	-8	-4	-5	-9	-18
50°	-39	-30	-16	-8	-4	-5	-8	-17

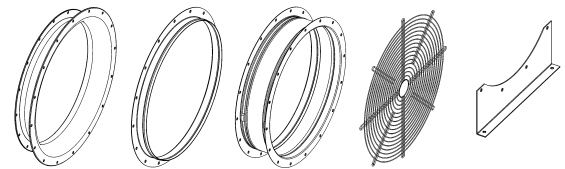

Accessories : see pages 104-106

Design	Pitch Angle	Type (G finish)	Part N°	Type (H finish)	Part N°	L1(mm)	L(mm)	Weight (kg)
K	30°	FV56V-4DK.B7.30.G	150341	FV56V-4DK.B7.30.H	150342	343	260	29
	35°	FV56V-4DK.B7.35.G	150345	FV56V-4DK.B7.35.H	150346	379	260	32
	40°	FV56V-4DK.C7.40.G	150349	FV56V-4DK.C7.40.H	150350	377	260	38
	45°	FV56V-4DK.D7.45.G	150381	FV56V-4DK.D7.45.H	150382	402	260	41
	50°	FV56V-4DK.D7.50.G	150357	FV56V-4DK.D7.50.H	150358	402	260	41
F	30°	FV56V-4DF.B7.30.G	150343	FV56V-4DF.B7.30.H	150344	---	470	35
	35°	FV56V-4DF.B7.35.G	150347	FV56V-4DF.B7.35.H	150348	---	470	39
	40°	FV56V-4DF.C7.40.G	150351	FV56V-4DF.C7.40.H	150352	---	470	45
	45°	FV56V-4DF.D7.45.G	150383	FV56V-4DF.D7.45.H	150384	---	470	47
	50°	FV56V-4DF.D7.50.G	150359	FV56V-4DF.D7.50.H	150360	---	470	47

FV56V-6D



50Hz Motor	U	I	P ₂	n	
	V	A	kW	min ⁻¹	
30°	71 M	400	0,18*	850	
35°	71 M	400	0,18*	850	
40°	71 M	400	0,25*	830	
45°	80 M	400	1,2	0,37*	920
50°	80 M	400	1,6	0,55*	910

*out of IE2 standard scope

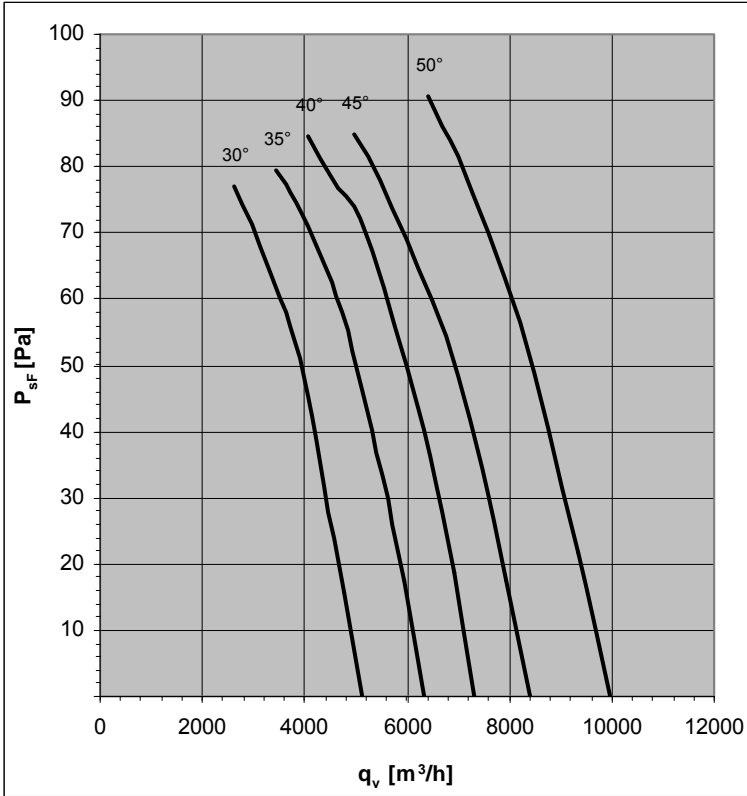

Design K

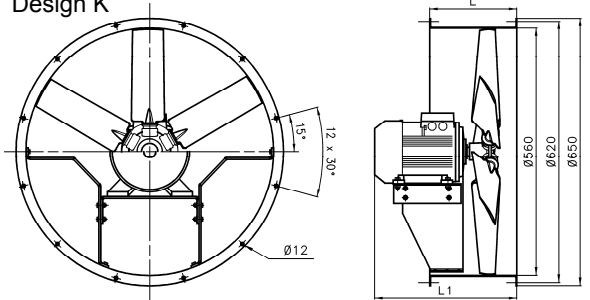

Design F

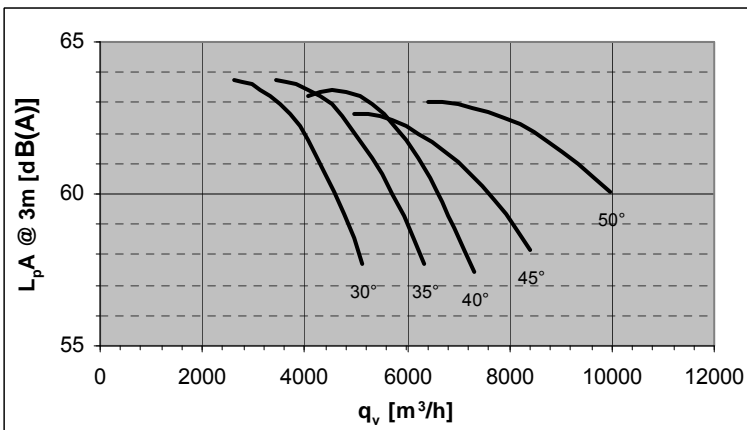
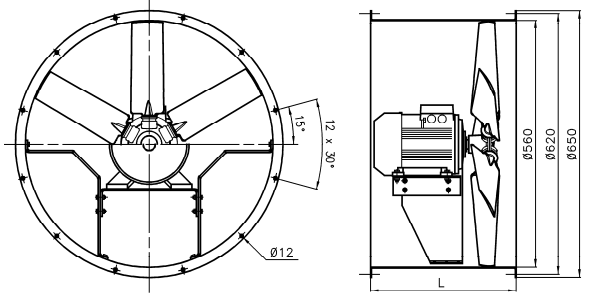

Pitch Angle	Relative spectrum LW dB(A)							
	63	125	250	500	1000	2000	4000	8000
30°	-38	-30	-13	-6	-4	-5	-10	-18
35°	-37	-29	-13	-6	-3	-5	-9	-17
40°	-36	-28	-13	-6	-3	-5	-8	-16
45°	-35	-27	-13	-7	-3	-5	-8	-15
50°	-35	-27	-14	-7	-4	-5	-8	-15

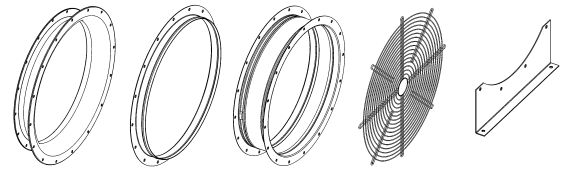

Accessories : see pages 104-106

Design	Pitch Angle	Type (G finish)	Part N°	Type (H finish)	Part N°	L1(mm)	L(mm)	Weight (kg)
K	30°	FV56V-6DK.A7.30.G	150361	FV56V-6DK.A7.30.H	150362	309	260	25
	35°	FV56V-6DK.A7.35.G	150365	FV56V-6DK.A7.35.H	150366	309	260	25
	40°	FV56V-6DK.A7.40.G	150369	FV56V-6DK.A7.40.H	150370	309	260	26
	45°	FV56V-6DK.B7.45.G	150385	FV56V-6DK.B7.45.H	150386	343	260	29
	50°	FV56V-6DK.B7.50.G	150389	FV56V-6DK.B7.50.H	150390	343	260	30
F	30°	FV56V-6DF.A7.30.G	150363	FV56V-6DF.A7.30.H	150364	---	470	31
	35°	FV56V-6DF.A7.35.G	150367	FV56V-6DF.A7.35.H	150368	---	470	31
	40°	FV56V-6DF.A7.40.G	150371	FV56V-6DF.A7.40.H	150372	---	470	33
	45°	FV56V-6DF.B7.45.G	150387	FV56V-6DF.B7.45.H	150388	---	470	35
	50°	FV56V-6DF.B7.50.G	150391	FV56V-6DF.B7.50.H	150392	---	470	36

Increased Temperature Range : -30°C / +60°C

FV63V-2D



50Hz Motor	U	I	P ₂	n	
	V	A	kW	min ⁻¹	
25°	132 S	400	10,4	5,5	2930
30°	132 S	400	14	7,5	2930
-	-	400	-	-	-
		400			
		400			

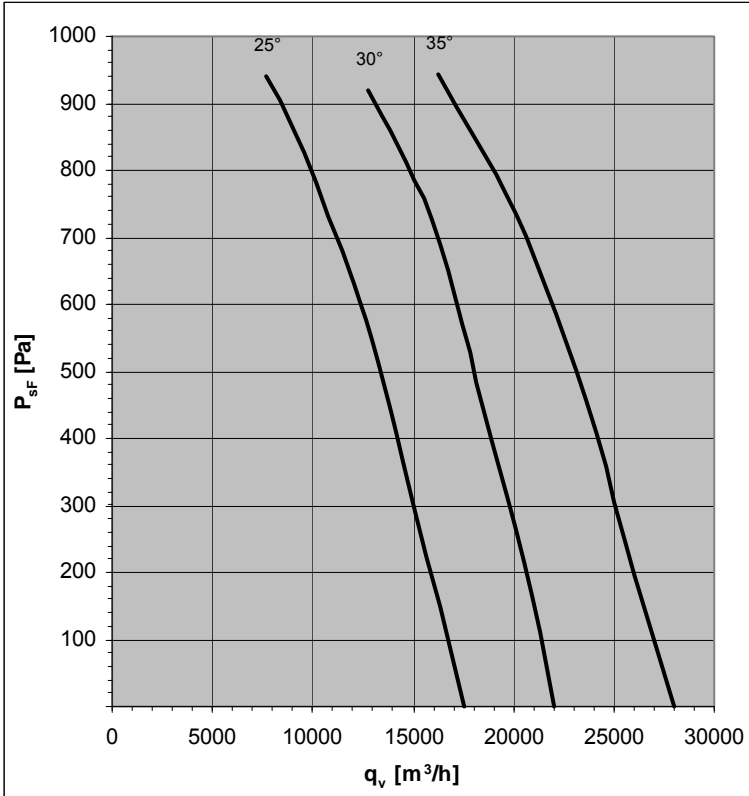

Design K

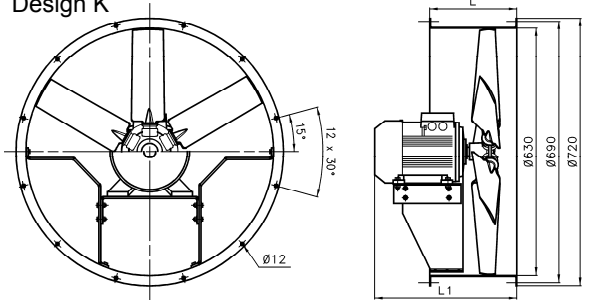

Design F

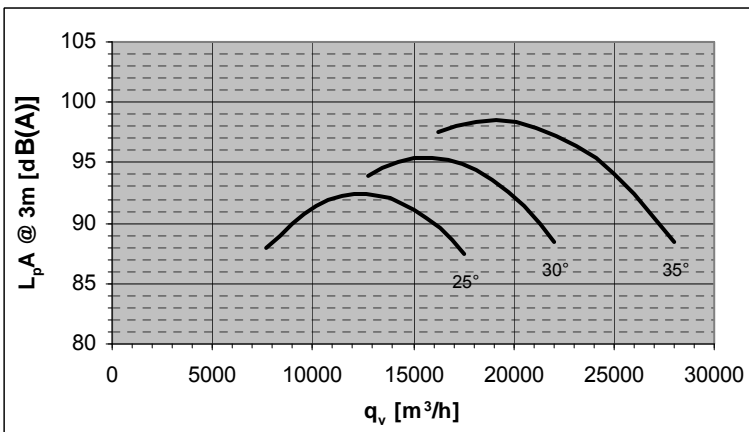
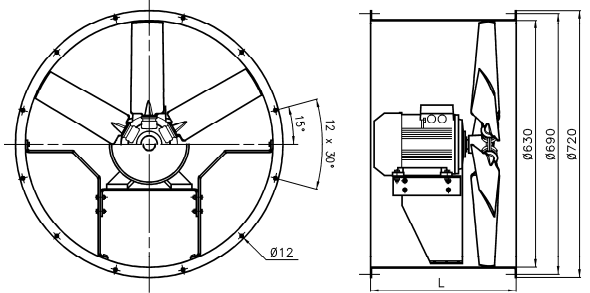

Pitch Angle	Relative spectrum LW dB(A)							
	63	125	250	500	1000	2000	4000	8000
25°	-53	-41	-18	-9	-5	-7	-13	-25
30°	-52	-41	-19	-9	-5	-7	-13	-24
35°	-50	-39	-19	-9	-5	-7	-12	-23

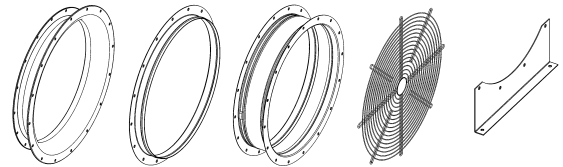

Accessories : see pages 104-106

Design	Pitch Angle	Type (G finish)	Part N°	Type (H finish)	Part N°	L1(mm)	L(mm)	Weight (kg)
K	25°	FV63V-2DK.G7.25.G	151042	FV63V-2DK.G7.25.H	151043	541	385	80
	30°	FV63V-2DK.G7.30.G	151046	FV63V-2DK.G7.30.H	151047	541	385	86
	-	-	-	-	-	---	---	---
F	25°	FV63V-2DF.G7.25.G	151044	FV63V-2DF.G7.25.H	151045	---	540	86
	30°	FV63V-2DF.G7.30.G	151048	FV63V-2DF.G7.30.H	151049	---	540	92
	-	-	-	-	-	---	---	---

Increased Temperature Range : -30°C / +60°C

FV63V-4D



50Hz Motor	U	I	P ₂	n	
	V	A	kW	min ⁻¹	
30°	90 S	400	2,53	1,1	1430
35°	90 L	400	3,31	1,5	1430
40°	100 L	400	4,65	2,2	1440
45°	100 L	400	4,65	2,2	1440
50°	100 L	400	6,18	3	1440

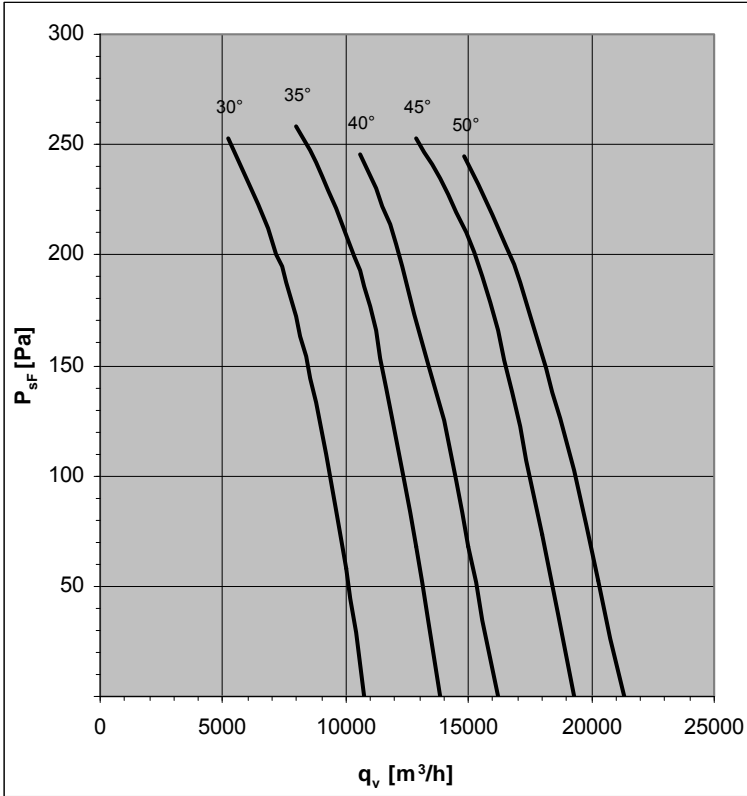

Design K

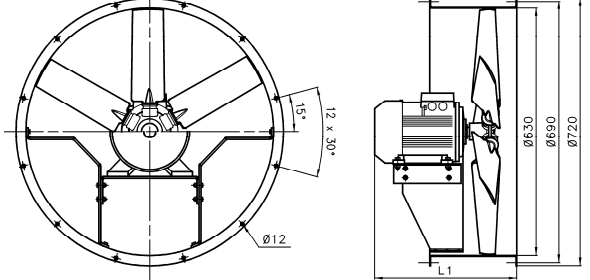

Design F

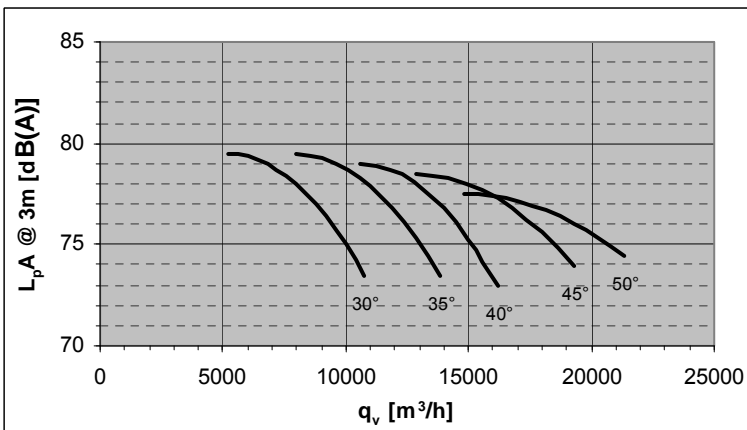
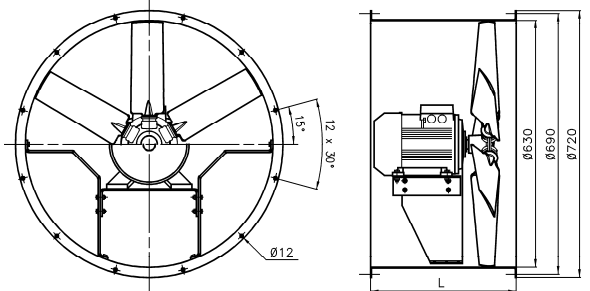

Pitch Angle	Relative spectrum LW dB(A)							
	63	125	250	500	1000	2000	4000	8000
30°	-46	-36	-16	-8	-4	-6	-12	-22
35°	-44	-35	-16	-8	-4	-6	-11	-21
40°	-43	-34	-16	-8	-4	-6	-10	-20
45°	-42	-33	-16	-8	-4	-6	-10	-19
50°	-41	-32	-17	-8	-4	-5	-9	-18

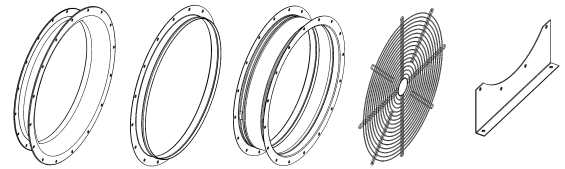

Accessories : see pages 104-106

Design	Pitch Angle	Type (G finish)	Part N°	Type (H finish)	Part N°	L1(mm)	L(mm)	Weight (kg)
K	30°	FV63V-4DK.C7.30.G	150393	FV63V-4DK.C7.30.H	150394	377	260	41
	35°	FV63V-4DK.D7.35.G	150397	FV63V-4DK.D7.35.H	150398	402	260	43
	40°	FV63V-4DK.E7.40.G	150453	FV63V-4DK.E7.40.H	150454	449	260	53
	45°	FV63V-4DK.E7.45.G	150405	FV63V-4DK.E7.45.H	150406	449	260	53
	50°	FV63V-4DK.E7.50.G	150409	FV63V-4DK.E7.50.H	150410	449	260	59
F	30°	FV63V-4DF.C7.30.G	150395	FV63V-4DF.C7.30.H	150396	---	470	48
	35°	FV63V-4DF.D7.35.G	150399	FV63V-4DF.D7.35.H	150400	---	470	51
	40°	FV63V-4DF.E7.40.G	150455	FV63V-4DF.E7.40.H	150456	---	470	61
	45°	FV63V-4DF.E7.45.G	150407	FV63V-4DF.E7.45.H	150408	---	470	61
	50°	FV63V-4DF.E7.50.G	150411	FV63V-4DF.E7.50.H	150412	---	470	67

Increased Temperature Range : -30°C / +60°C

FV63V-6D



50Hz Motor	U	I	P ₂	n	
	V	A	kW	min ⁻¹	
30°	71 M	400	0,79	0,25*	830
35°	80 M	400	1,2	0,37*	920
40°	80 M	400	1,6	0,55*	910
45°	90 S	400	1,98	0,75	920
50°	90 S	400	1,98	0,75	920

*out of IE2 standard scope

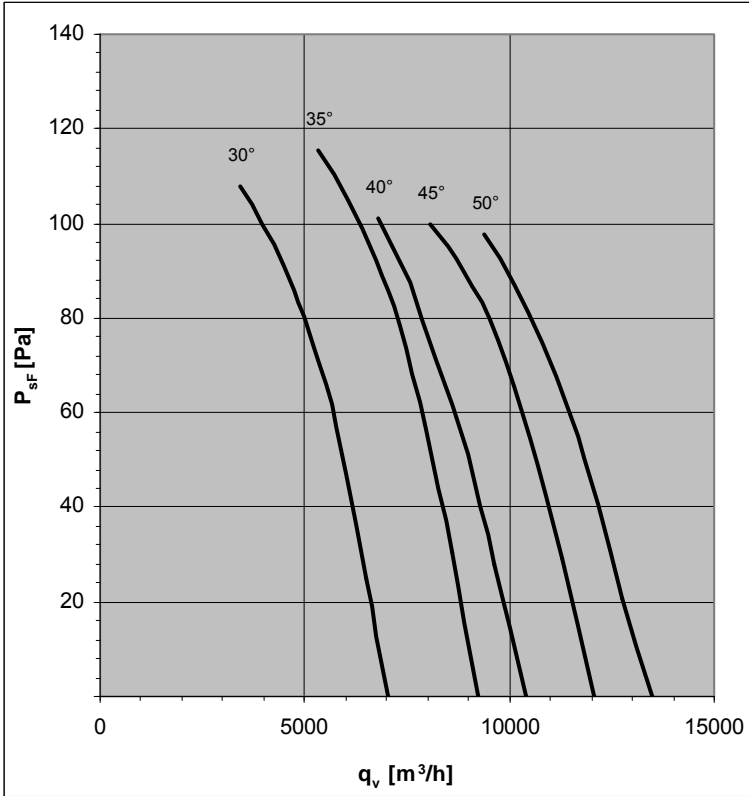

Design K

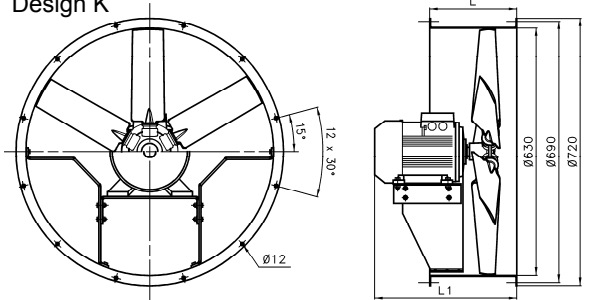

Design F

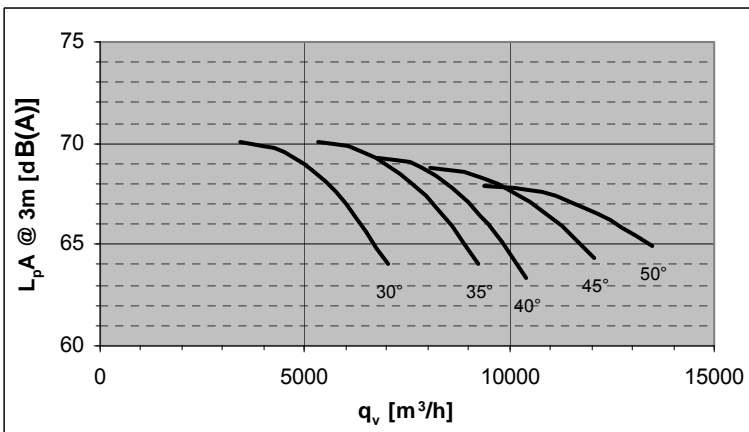
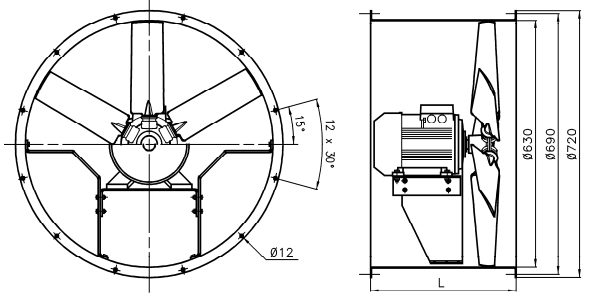

Pitch Angle	Relative spectrum LW dB(A)							
	63	125	250	500	1000	2000	4000	8000
30°	-41	-32	-14	-7	-4	-6	-10	-20
35°	-40	-31	-14	-7	-4	-5	-10	-19
40°	-38	-30	-14	-7	-4	-5	-9	-17
45°	-38	-29	-15	-7	-4	-5	-9	-17
50°	-37	-29	-15	-7	-4	-5	-8	-16

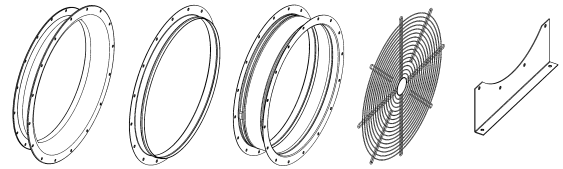

Accessories : see pages 104-106

Design	Pitch Angle	Type (G finish)	Part N°	Type (H finish)	Part N°	L1(mm)	L(mm)	Weight (kg)
K	30°	FV63V-6DK.A7.30.G	150413	FV63V-6DK.A7.30.H	150414	309	260	29
	35°	FV63V-6DK.B7.35.G	150417	FV63V-6DK.B7.35.H	150418	343	260	31
	40°	FV63V-6DK.B7.40.G	150421	FV63V-6DK.B7.40.H	150422	343	260	32
	45°	FV63V-6DK.C7.45.G	150457	FV63V-6DK.C7.45.H	150458	377	260	41
	50°	FV63V-6DK.C7.50.G	150429	FV63V-6DK.C7.50.H	150430	377	260	41
F	30°	FV63V-6DF.A7.30.G	150415	FV63V-6DF.A7.30.H	150416	---	470	36
	35°	FV63V-6DF.B7.35.G	150419	FV63V-6DF.B7.35.H	150420	---	470	39
	40°	FV63V-6DF.B7.40.G	150423	FV63V-6DF.B7.40.H	150424	---	470	40
	45°	FV63V-6DF.C7.45.G	150459	FV63V-6DF.C7.45.H	150460	---	470	48
	50°	FV63V-6DF.C7.50.G	150431	FV63V-6DF.C7.50.H	150432	---	470	48

FV63V-8D



50Hz Motor	U	I	P ₂	n	
	V	A	kW	min ⁻¹	
30°	71 M	400	0,36	0,09*	630
35°	71 M	400	0,51	0,12*	645
40°	80 M	400	0,75	0,18*	675
45°	80 M	400	1,02	0,25*	685
50°	90 S	400	1,14	0,37*	675

*out of IE2 standard scope

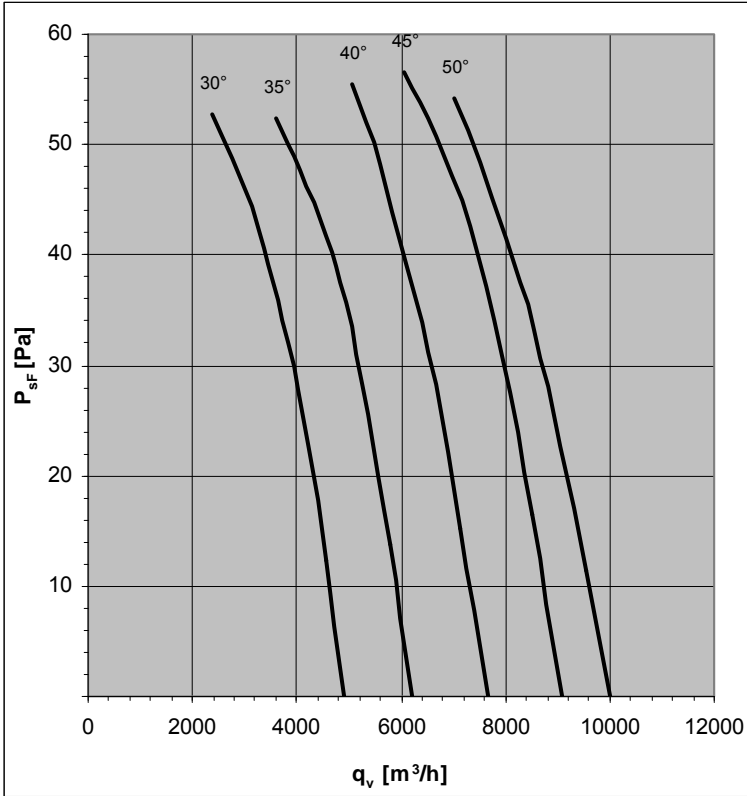

Design K

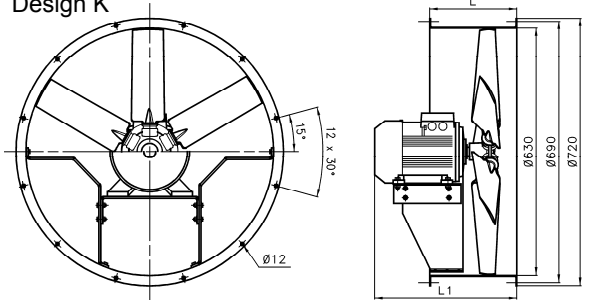

Design F

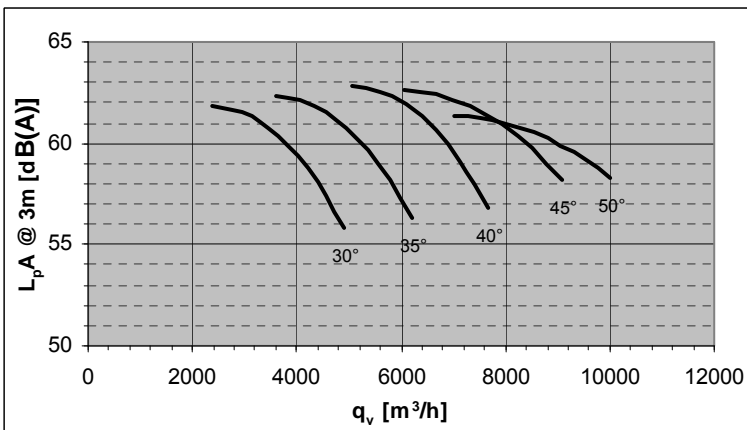
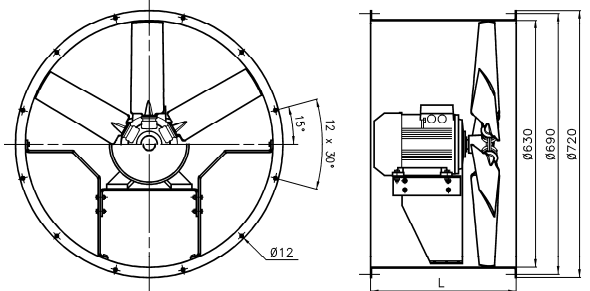

Pitch Angle	Relative spectrum LW dB(A)							
	63	125	250	500	1000	2000	4000	8000
30°	-37	-29	-13	-6	-3	-5	-9	-18
35°	-36	-28	-13	-6	-3	-5	-9	-17
40°	-35	-28	-13	-6	-3	-5	-8	-16
45°	-35	-27	-13	-7	-3	-5	-8	-15
50°	-34	-26	-14	-7	-3	-4	-7	-14

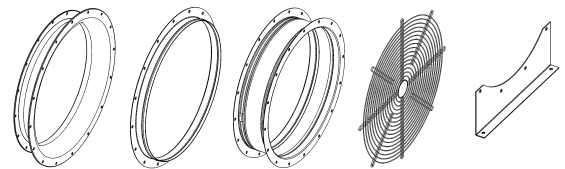

Accessories : see pages 104-106

Design	Pitch Angle	Type (G finish)	Part N°	Type (H finish)	Part N°	L1(mm)	L(mm)	Weight (kg)
K	30°	FV63V-8DK.A7.30.G	150433	FV63V-8DK.A7.30.H	150434	309	260	29
	35°	FV63V-8DK.A7.35.G	150437	FV63V-8DK.A7.35.H	150438	309	260	29
	40°	FV63V-8DK.B7.40.G	150441	FV63V-8DK.B7.40.H	150442	343	260	31
	45°	FV63V-8DK.B7.45.G	150445	FV63V-8DK.B7.45.H	150446	343	260	32
	50°	FV63V-8DK.C7.50.G	150461	FV63V-8DK.C7.50.H	150462	398	260	33
F	30°	FV63V-8DF.A7.30.G	150435	FV63V-8DF.A7.30.H	150436	---	470	36
	35°	FV63V-8DF.A7.35.G	150439	FV63V-8DF.A7.35.H	150440	---	470	36
	40°	FV63V-8DF.B7.40.G	150443	FV63V-8DF.B7.40.H	150444	---	470	39
	45°	FV63V-8DF.B7.45.G	150447	FV63V-8DF.B7.45.H	150448	---	470	40
	50°	FV63V-8DF.C7.50.G	150463	FV63V-8DF.C7.50.H	150464	---	470	40

Increased Temperature Range : -30°C / +60°C

FV71V-4D



50Hz Motor	U	I	P ₂	n	
	V	A	kW	min ⁻¹	
25°	90 L	400	3,31	1,5	1430
30°	100 L	400	4,65	2,2	1440
35°	100 L	400	6,18	3	1440
40°	112 M	400	8,13	4	1450
45°	132 S	400	10,9	5,5	1460

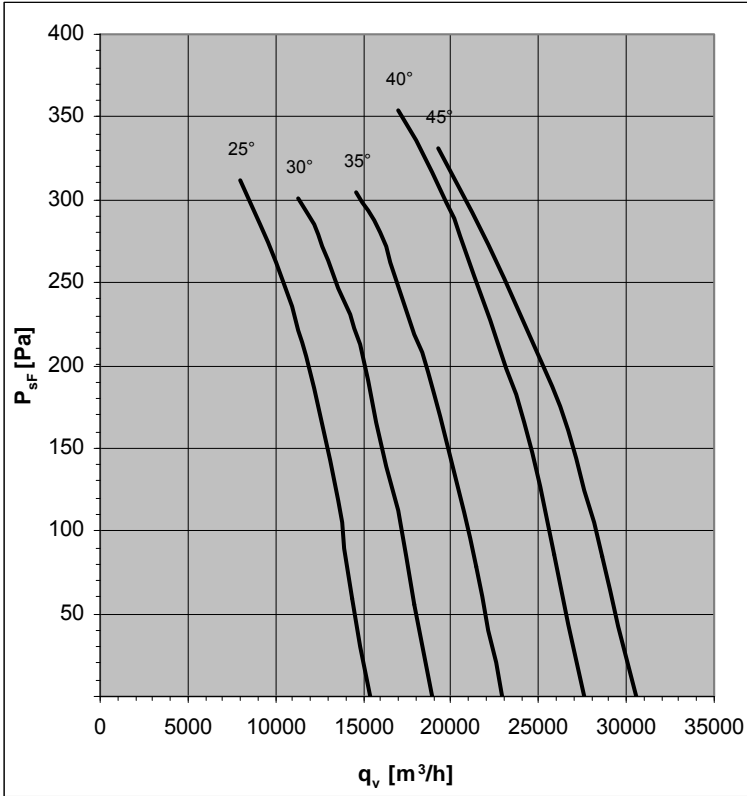

Design K

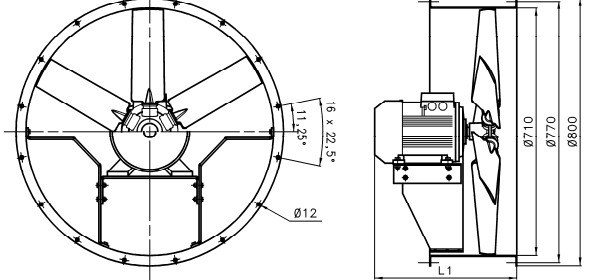

Design F

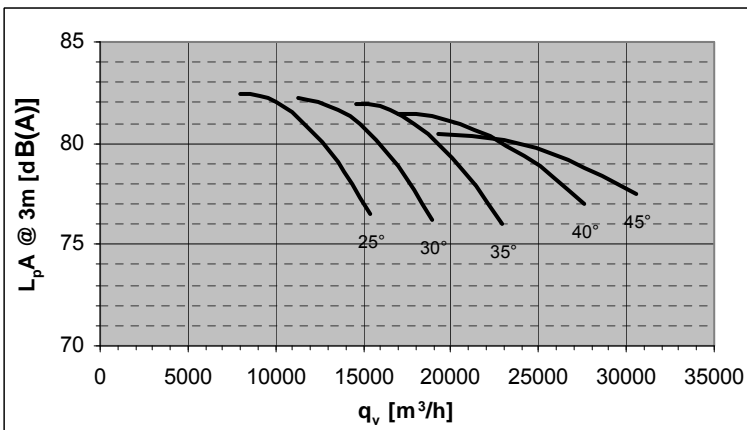
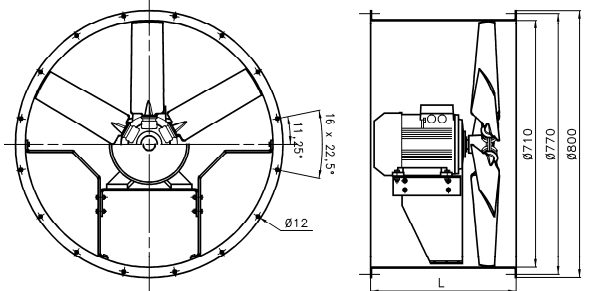

Pitch Angle	Relative spectrum LW dB(A)							
	63	125	250	500	1000	2000	4000	8000
25°	-47	-37	-16	-8	-4	-6	-12	-23
30°	-46	-36	-16	-8	-4	-6	-11	-21
35°	-44	-35	-17	-8	-4	-6	-10	-20
40°	-44	-34	-17	-8	-4	-6	-10	-19
45°	-43	-33	-17	-8	-4	-6	-9	-18

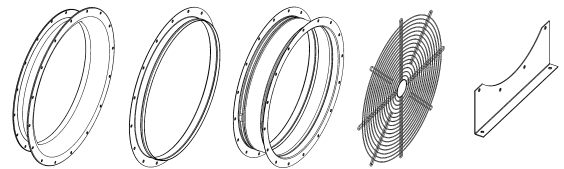

Accessories : see pages 104-106

Design	Pitch Angle	Type (G finish)	Part N°	Type (H finish)	Part N°	L1(mm)	L(mm)	Weight (kg)
K	25°	FV71V-4DK.D7.25.G	150465	FV71V-4DK.D7.25.H	150466	424	280	48
	30°	FV71V-4DK.E7.30.G	150469	FV71V-4DK.E7.30.H	150470	471	280	58
	35°	FV71V-4DK.E7.35.G	150473	FV71V-4DK.E7.35.H	150474	471	280	64
	40°	FV71V-4DK.F7.40.G	150477	FV71V-4DK.F7.40.H	150478	488	400	79
	45°	FV71V-4DK.G7.45.G	150525	FV71V-4DK.G7.45.H	150526	562	400	90
F	25°	FV71V-4DF.D7.25.G	150467	FV71V-4DF.D7.25.H	150468	---	500	58
	30°	FV71V-4DF.E7.30.G	150471	FV71V-4DF.E7.30.H	150472	---	500	68
	35°	FV71V-4DF.E7.35.G	150475	FV71V-4DF.E7.35.H	150476	---	500	74
	40°	FV71V-4DF.F7.40.G	150479	FV71V-4DF.F7.40.H	150480	---	560	86
	45°	FV71V-4DF.G7.45.G	150527	FV71V-4DF.G7.45.H	150528	---	560	96

FV71V-6D



50Hz Motor	U	I	P ₂	n	
	V	A	kW	min ⁻¹	
25°	80 M	400	1,6	0,55*	910
30°	80 M	400	1,6	0,55*	910
35°	90 S	400	1,98	0,75	920
40°	90 L	400	2,78	1,1	920
45°	90 L	400	2,78	1,1	920

*out of IE2 standard scope

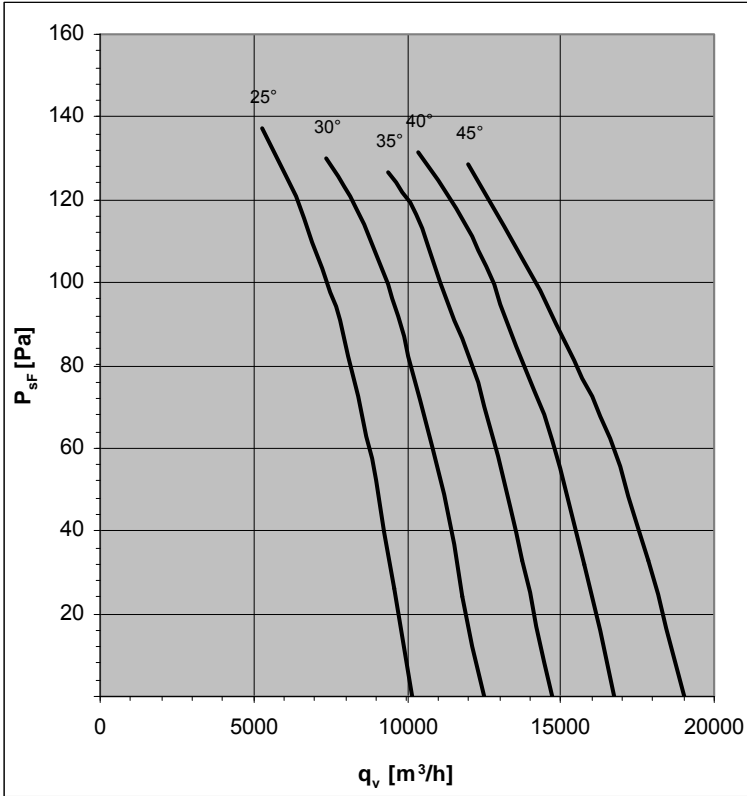

Design K

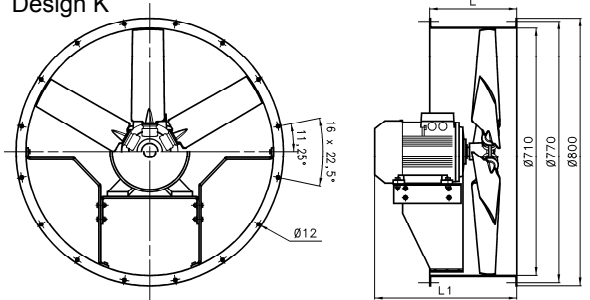

Design F

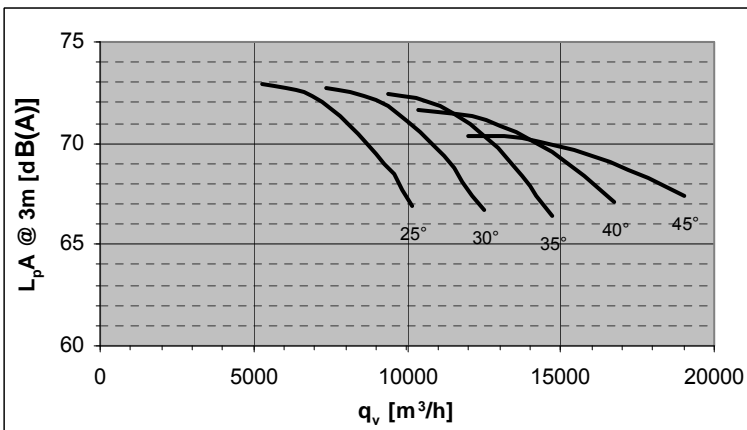
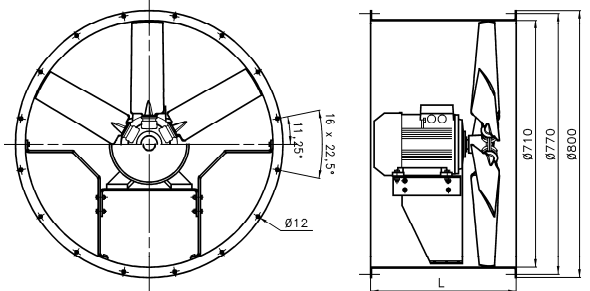

Pitch Angle	Relative spectrum LW dB(A)							
	63	125	250	500	1000	2000	4000	8000
25°	-42	-33	-15	-7	-4	-6	-11	-20
30°	-41	-32	-15	-7	-4	-6	-10	-19
35°	-40	-31	-15	-7	-4	-5	-9	-18
40°	-39	-30	-15	-7	-4	-5	-9	-17
45°	-38	-30	-15	-7	-4	-5	-8	-16

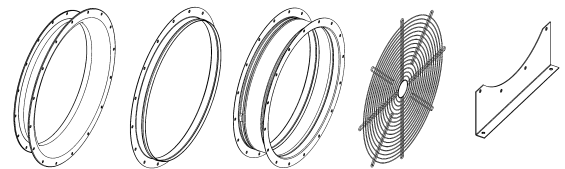

Accessories : see pages 104-106

Design	Pitch Angle	Type (G finish)	Part N°	Type (H finish)	Part N°	L1(mm)	L(mm)	Weight (kg)
K	25°	FV71V-6DK.B7.25.G	150529	FV71V-6DK.B7.25.H	150530	365	280	37
	30°	FV71V-6DK.B7.30.G	150489	FV71V-6DK.B7.30.H	150490	365	280	37
	35°	FV71V-6DK.C7.35.G	150493	FV71V-6DK.C7.35.H	150494	399	280	46
	40°	FV71V-6DK.D7.40.G	150497	FV71V-6DK.D7.40.H	150498	424	280	48
	45°	FV71V-6DK.D7.45.G	150501	FV71V-6DK.D7.45.H	150502	424	280	48
F	25°	FV71V-6DF.B7.25.G	150531	FV71V-6DF.B7.25.H	150532	---	500	47
	30°	FV71V-6DF.B7.30.G	150491	FV71V-6DF.B7.30.H	150492	---	500	47
	35°	FV71V-6DF.C7.35.G	150495	FV71V-6DF.C7.35.H	150496	---	500	55
	40°	FV71V-6DF.D7.40.G	150499	FV71V-6DF.D7.40.H	150500	---	500	58
	45°	FV71V-6DF.D7.45.G	150503	FV71V-6DF.D7.45.H	150504	---	500	58

Increased Temperature Range : -30°C / +60°C

FV71V-8D



50Hz Motor	U	I	P ₂	n	
	V	A	kW	min ⁻¹	
25°	80 M	400	0,75	0,18*	675
30°	80 M	400	1,02	0,25*	685
35°	90 S	400	1,14	0,37*	675
40°	90 S	400	1,14	0,37*	675
45°	90 L	400	1,58	0,55*	675

*out of IE2 standard scope

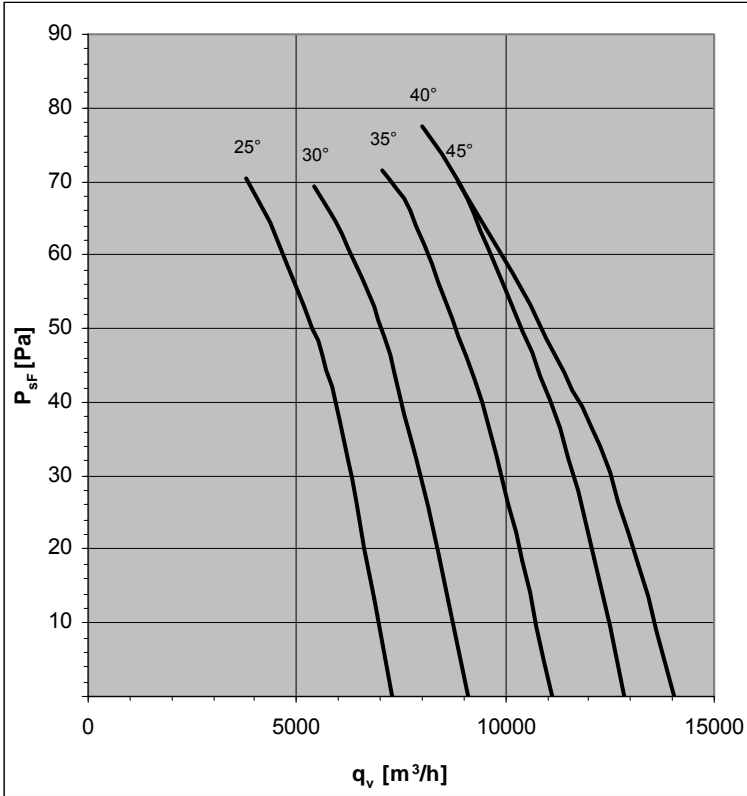

Design K

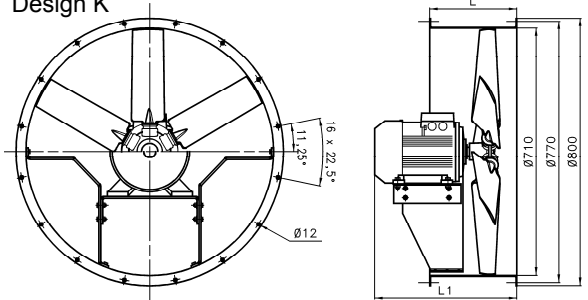

Design F

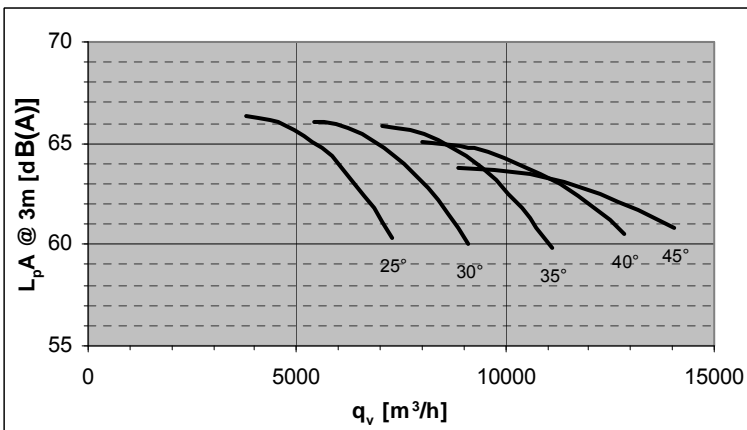
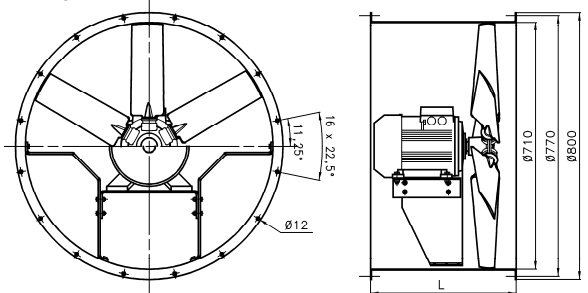

Pitch Angle	Relative spectrum LW dB(A)							
	63	125	250	500	1000	2000	4000	8000
25°	-39	-31	-13	-7	-4	-5	-10	-19
30°	-38	-30	-14	-7	-4	-5	-9	-18
35°	-37	-29	-14	-7	-4	-5	-9	-17
40°	-36	-28	-14	-7	-4	-5	-8	-16
45°	-35	-27	-14	-7	-4	-5	-8	-15

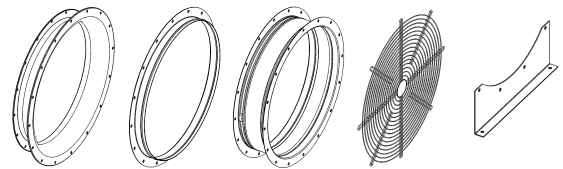

Accessories : see pages 104-106

Design	Pitch Angle	Type (G finish)	Part N°	Type (H finish)	Part N°	L1(mm)	L(mm)	Weight (kg)
K	25°	FV71V-8DK.B7.25.G	150505	FV71V-8DK.B7.25.H	150506	365	280	36
	30°	FV71V-8DK.B7.30.G	150509	FV71V-8DK.B7.30.H	150510	365	280	37
	35°	FV71V-8DK.C7.35.G	150513	FV71V-8DK.C7.35.H	150514	420	280	38
	40°	FV71V-8DK.C7.40.G	150517	FV71V-8DK.C7.40.H	150518	420	280	38
	45°	FV71V-8DK.D7.45.G	150521	FV71V-8DK.D7.45.H	150522	420	280	40
F	25°	FV71V-8DF.B7.25.G	150507	FV71V-8DF.B7.25.H	150508	---	500	46
	30°	FV71V-8DF.B7.30.G	150511	FV71V-8DF.B7.30.H	150512	---	500	47
	35°	FV71V-8DF.C7.35.G	150515	FV71V-8DF.C7.35.H	150516	---	500	47
	40°	FV71V-8DF.C7.40.G	150519	FV71V-8DF.C7.40.H	150520	---	500	47
	45°	FV71V-8DF.D7.45.G	150523	FV71V-8DF.D7.45.H	150524	---	500	50

FV80V-4D



50Hz Motor	U	I	P ₂	n	
	V	A	kW	min ⁻¹	
25°	100 L	400	4,65	2,2	1440
30°	100 L	400	6,18	3	1440
35°	132 S	400	10,9	5,5	1460
40°	132 M	400	14,5	7,5	1460
45°	132 M	400	14,5	7,5	1460

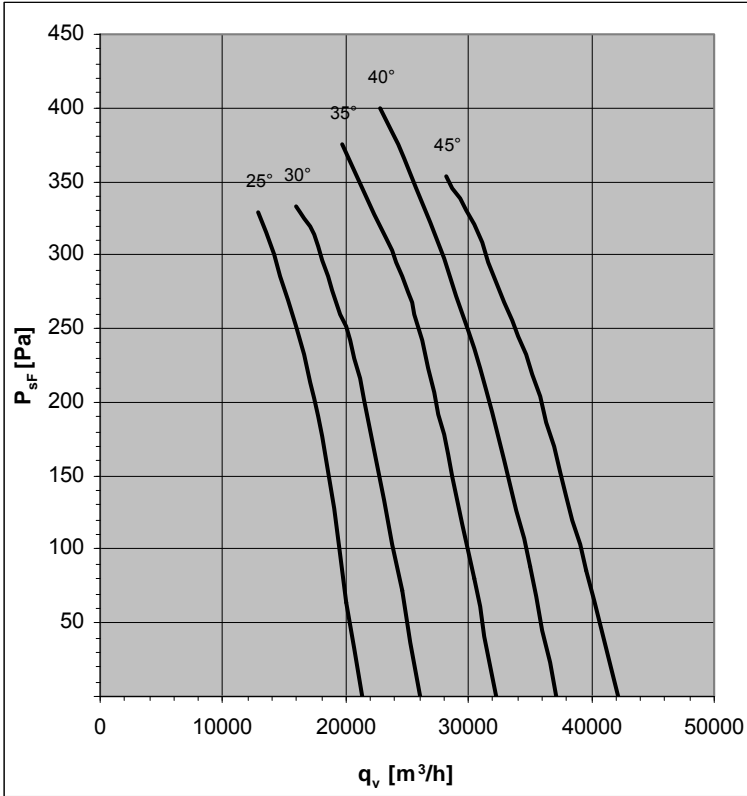

Design K

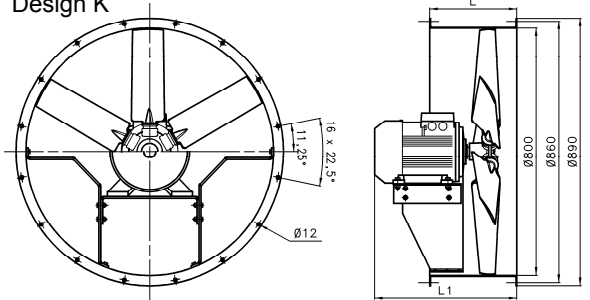

Design F

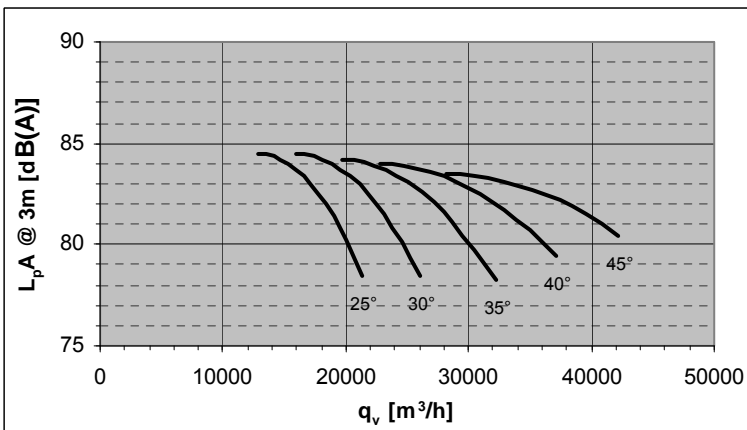
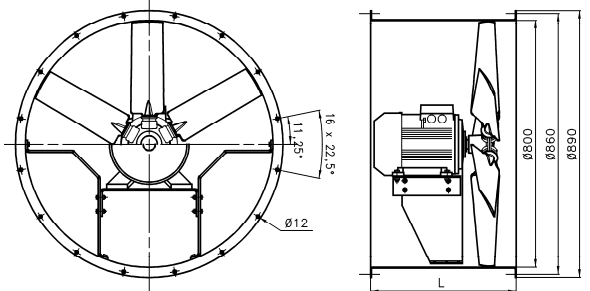

Pitch Angle	Relative spectrum LW dB(A)							
	63	125	250	500	1000	2000	4000	8000
25°	-48	-38	-17	-8	-4	-7	-12	-23
30°	-47	-37	-17	-8	-4	-6	-12	-22
35°	-45	-36	-17	-8	-4	-6	-11	-21
40°	-45	-35	-17	-8	-4	-6	-10	-20
45°	-44	-34	-18	-9	-4	-6	-9	-19

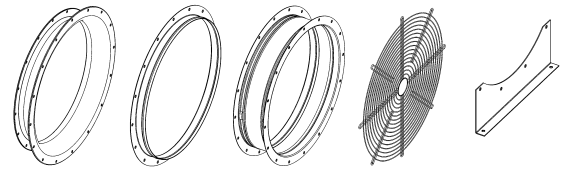

Accessories : see pages 104-106

Design	Pitch Angle	Type (G finish)	Part N°	Type (H finish)	Part N°	L1(mm)	L(mm)	Weight (kg)
K	25°	FV80V-4DK.E7.25.G	150533	FV80V-4DK.E7.25.H	150534	471	280	66
	30°	FV80V-4DK.E7.30.G	150537	FV80V-4DK.E7.30.H	150538	471	280	72
	35°	FV80V-4DK.G7.35.G	150593	FV80V-4DK.G7.35.H	150594	562	400	99
	40°	FV80V-4DK.H7.40.G	150597	FV80V-4DK.H7.40.H	150598	562	400	111
	45°	FV80V-4DK.H7.45.G	150549	FV80V-4DK.H7.45.H	150550	562	400	111
F	25°	FV80V-4DF.E7.25.G	150535	FV80V-4DF.E7.25.H	150536	---	500	78
	30°	FV80V-4DF.E7.30.G	150539	FV80V-4DF.E7.30.H	150540	---	500	84
	35°	FV80V-4DF.G7.35.G	150595	FV80V-4DF.G7.35.H	150596	---	700	117
	40°	FV80V-4DF.H7.40.G	150599	FV80V-4DF.H7.40.H	150600	---	700	128
	45°	FV80V-4DF.H7.45.G	150551	FV80V-4DF.H7.45.H	150552	---	700	128

FV80V-6D



50Hz Motor	U	I	P ₂	n	
	V	A	kW	min ⁻¹	
25°	80 M	400	1,6	0,55*	910
30°	90 L	400	2,78	1,1	920
35°	100 L	400	3,62	1,5	940
40°	100 L	400	3,62	1,5	940
45°	112 M	400	5,11	2,2	960

*out of IE2 standard scope

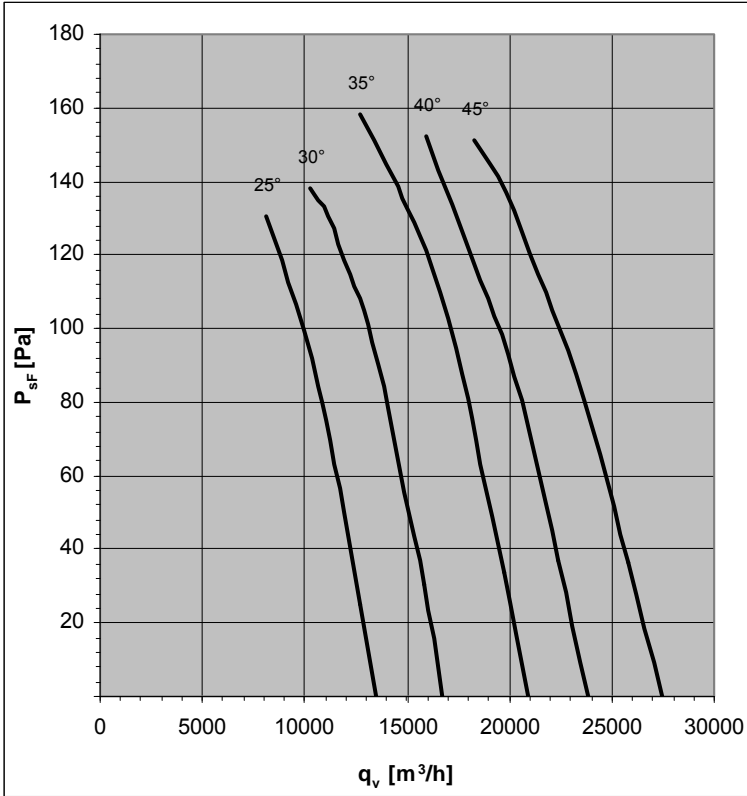

Design K

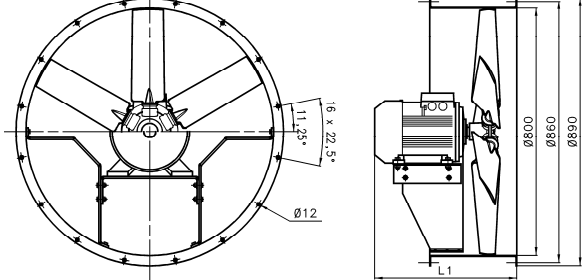

Design F

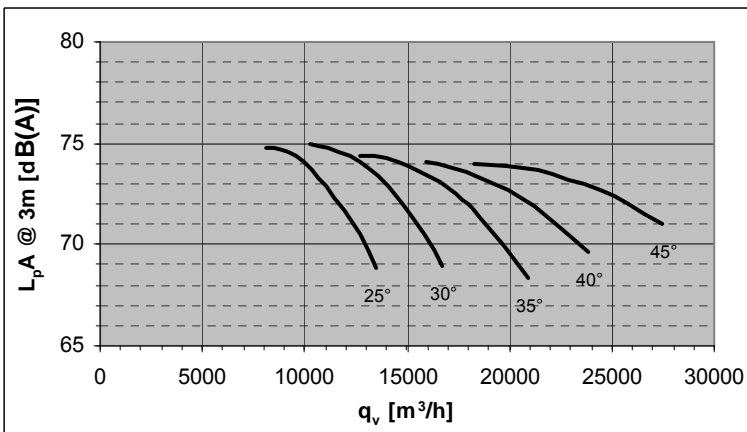
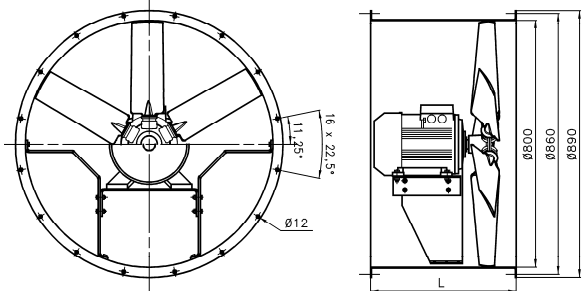

Pitch Angle	Relative spectrum LW dB(A)							
	63	125	250	500	1000	2000	4000	8000
25°	-43	-34	-15	-7	-4	-6	-11	-21
30°	-42	-33	-15	-7	-4	-6	-10	-20
35°	-41	-32	-15	-7	-4	-5	-10	-19
40°	-40	-31	-16	-8	-4	-5	-9	-18
45°	-40	-31	-16	-8	-4	-5	-9	-17

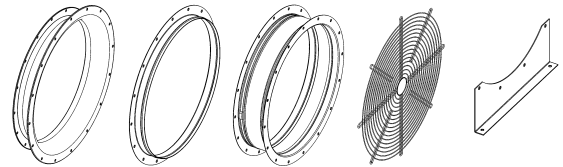

Accessories : see pages 104-106

Design	Pitch Angle	Type (G finish)	Part N°	Type (H finish)	Part N°	L1(mm)	L(mm)	Weight (kg)
K	25°	FV80V-6DK.B7.25.G	150553	FV80V-6DK.B7.25.H	150554	365	280	45
	30°	FV80V-6DK.D7.30.G	150601	FV80V-6DK.D7.30.H	150602	424	280	56
	35°	FV80V-6DK.E7.35.G	150605	FV80V-6DK.E7.35.H	150606	471	280	63
	40°	FV80V-6DK.E7.40.G	150565	FV80V-6DK.E7.40.H	150566	471	280	63
	45°	FV80V-6DK.F7.45.G	150569	FV80V-6DK.F7.45.H	150570	488	400	80
F	25°	FV80V-6DF.B7.25.G	150555	FV80V-6DF.B7.25.H	150556	---	500	57
	30°	FV80V-6DF.D7.30.G	150603	FV80V-6DF.D7.30.H	150604	---	500	68
	35°	FV80V-6DF.E7.35.G	150607	FV80V-6DF.E7.35.H	150608	---	500	76
	40°	FV80V-6DF.E7.40.G	150567	FV80V-6DF.E7.40.H	150568	---	500	76
	45°	FV80V-6DF.F7.45.G	150571	FV80V-6DF.F7.45.H	150572	---	540	86

FV80V-8D



50Hz Motor	U	I	P ₂	n	
	V	A	kW	min ⁻¹	
25°	80 M	400	1,02	0,25*	685
30°	90 S	400	1,14	0,37*	675
35°	90 L	400	1,58	0,55*	675
40°	100 L	400	2,8	0,75*	725
45°	100 L	400	2,8	0,75*	725

*out of IE2 standard scope

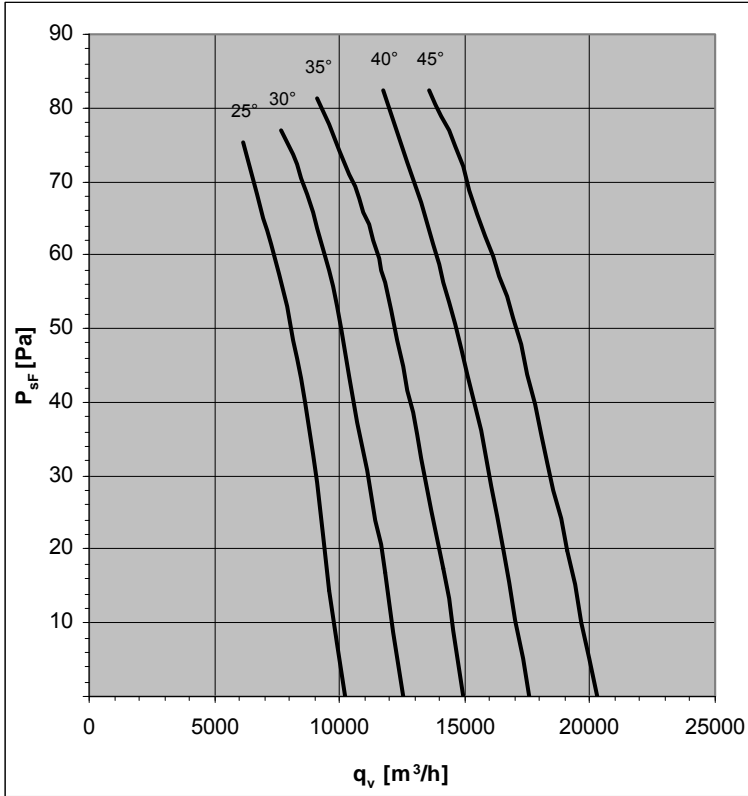

Design K

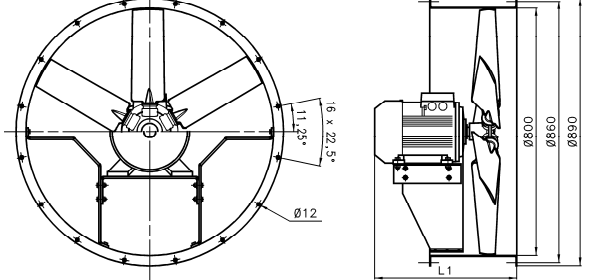

Design F

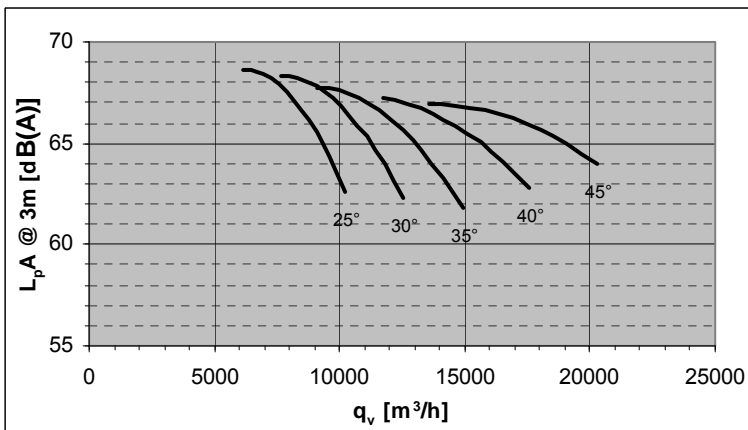
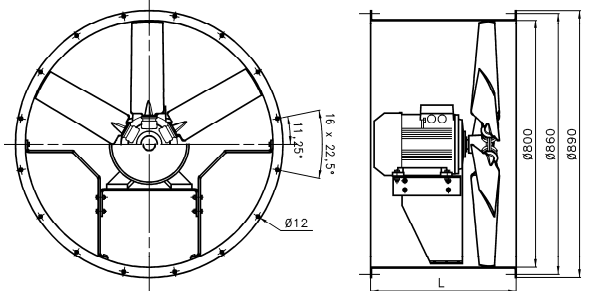

Pitch Angle	Relative spectrum LW dB(A)							
	63	125	250	500	1000	2000	4000	8000
25°	-40	-32	-14	-7	-4	-5	-10	-19
30°	-39	-31	-14	-7	-4	-5	-10	-18
35°	-38	-29	-14	-7	-4	-5	-9	-17
40°	-37	-29	-14	-7	-4	-5	-8	-16
45°	-37	-28	-15	-7	-4	-5	-8	-16

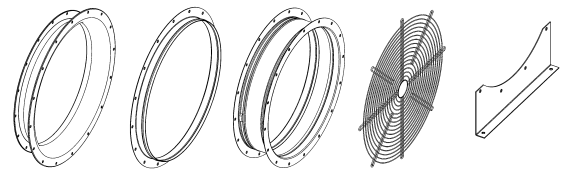

Accessories : see pages 104-106

Design	Pitch Angle	Type (G finish)	Part N°	Type (H finish)	Part N°	L1(mm)	L(mm)	Weight (kg)
K	25°	FV80V-8DK.B7.25.G	150573	FV80V-8DK.B7.25.H	150574	365	280	45
	30°	FV80V-8DK.C7.30.G	150577	FV80V-8DK.C7.30.H	150578	420	280	45
	35°	FV80V-8DK.D7.35.G	150581	FV80V-8DK.D7.35.H	150582	420	280	48
	40°	FV80V-8DK.E7.40.G	150609	FV80V-8DK.E7.40.H	150610	484	280	56
	45°	FV80V-8DK.E7.45.G	150589	FV80V-8DK.E7.45.H	150590	484	280	56
F	25°	FV80V-8DF.B7.25.G	150575	FV80V-8DF.B7.25.H	150576	---	500	57
	30°	FV80V-8DF.C7.30.G	150579	FV80V-8DF.C7.30.H	150580	---	500	58
	35°	FV80V-8DF.D7.35.G	150583	FV80V-8DF.D7.35.H	150584	---	500	61
	40°	FV80V-8DF.E7.40.G	150611	FV80V-8DF.E7.40.H	150612	---	500	68
	45°	FV80V-8DF.E7.45.G	150591	FV80V-8DF.E7.45.H	150592	---	500	68

FV90V-4D



50Hz Motor	U	I	P ₂	n	
	V	A	kW	min ⁻¹	
25°	100 L	400	6,18	3	1440
30°	132 S	400	10,9	5,5	1460
35°	132 M	400	14,5	7,5	1460
40°	160 M	400	21	11	1470
45°	160 M	400	21	11	1470

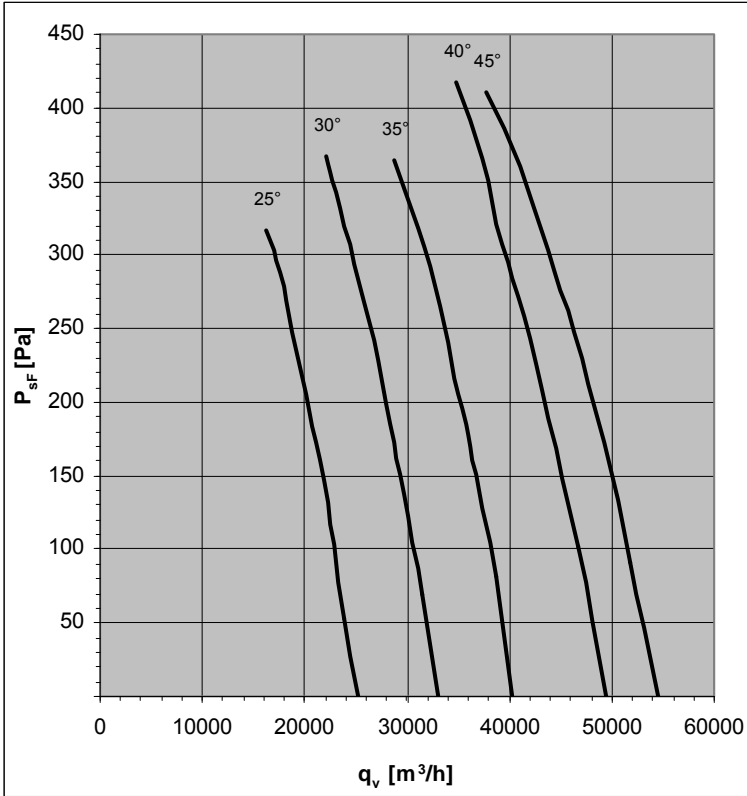

Design K

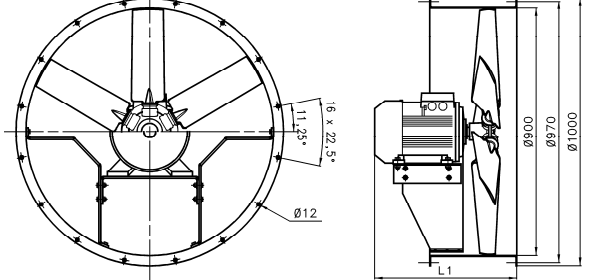

Design F

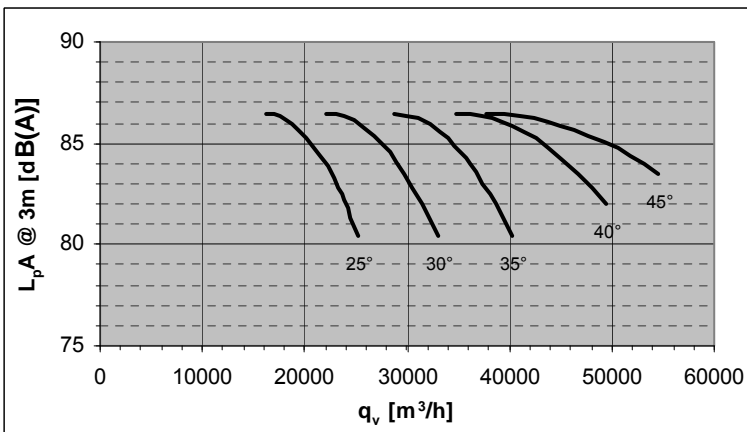
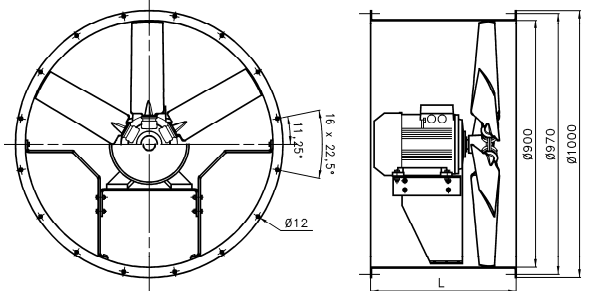

Pitch Angle	Relative spectrum LW dB(A)							
	63	125	250	500	1000	2000	4000	8000
25°	-49	-39	-17	-8	-5	-7	-13	-24
30°	-48	-38	-17	-8	-5	-6	-12	-22
35°	-47	-36	-17	-8	-5	-6	-11	-21
40°	-46	-36	-18	-9	-5	-6	-10	-20
45°	-45	-35	-18	-9	-5	-6	-10	-19

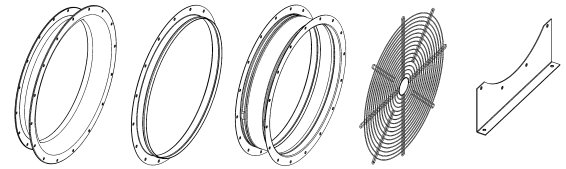

Accessories : see pages 104-106

Design	Pitch Angle	Type (G finish)	Part N°	Type (H finish)	Part N°	L1(mm)	L(mm)	Weight (kg)
K	25°	FV90V-4DK.E7.25.G	150613	FV90V-4DK.E7.25.H	150614	471	280	78
	30°	FV90V-4DK.G7.30.G	150673	FV90V-4DK.G7.30.H	150674	562	400	106
	35°	FV90V-4DK.H7.35.G	150677	FV90V-4DK.H7.35.H	150678	562	400	118
	40°	FV90V-4DK.I7.40.G	150681	FV90V-4DK.I7.40.H	150682	702	400	197
	45°	FV90V-4DK.I7.45.G	150629	FV90V-4DK.I7.45.H	150630	702	400	197
F	25°	FV90V-4DF.E7.25.G	150615	FV90V-4DF.E7.25.H	150616	---	500	92
	30°	FV90V-4DF.G7.30.G	150675	FV90V-4DF.G7.30.H	150676	---	700	124
	35°	FV90V-4DF.H7.35.G	150679	FV90V-4DF.H7.35.H	150680	---	700	136
	40°	FV90V-4DF.I7.40.G	150683	FV90V-4DF.I7.40.H	150684	---	700	216
	45°	FV90V-4DF.I7.45.G	150631	FV90V-4DF.I7.45.H	150632	---	700	216

FV90V-6D



50Hz Motor	U	I	P ₂	n	
	V	A	kW	min ⁻¹	
25°	90 S	400	1,98	0,75	920
30°	90 L	400	2,78	1,1	920
35°	112 M	400	5,11	2,2	960
40°	112 M	400	5,11	2,2	960
45°	132 S	400	6,84	3	960

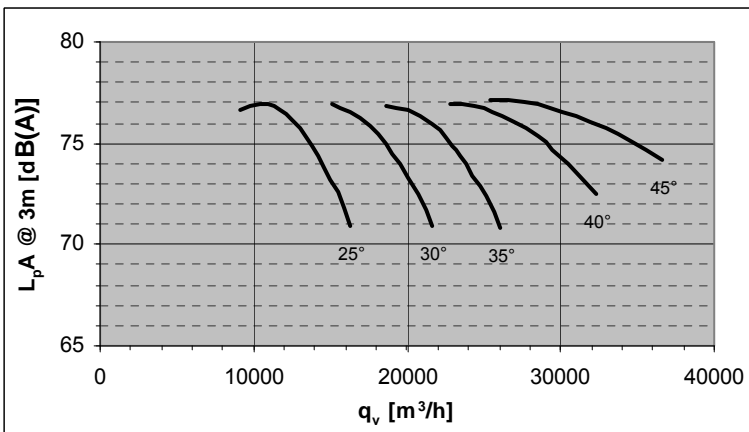
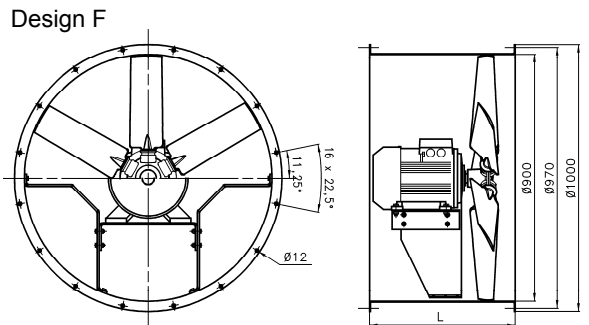
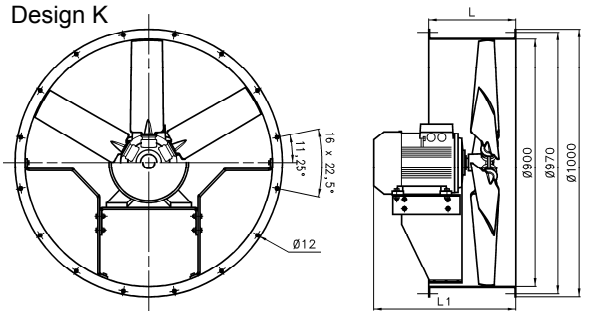
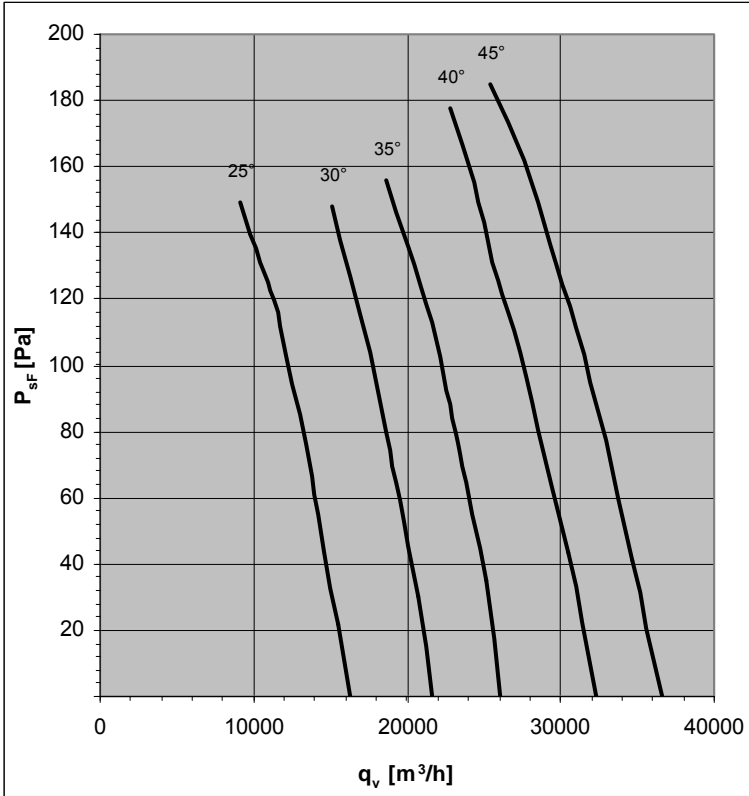

Pitch Angle	Relative spectrum LW dB(A)							
	63	125	250	500	1000	2000	4000	8000
25°	-44	-35	-15	-8	-4	-6	-11	-21
30°	-43	-34	-15	-8	-4	-6	-11	-20
35°	-42	-33	-16	-8	-4	-6	-10	-19
40°	-42	-32	-16	-8	-4	-6	-9	-18
45°	-41	-32	-16	-8	-4	-5	-9	-18

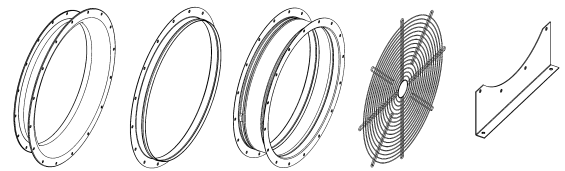

Accessories : see pages 104-106

Design	Pitch Angle	Type (G finish)	Part N°	Type (H finish)	Part N°	L1(mm)	L(mm)	Weight (kg)
K	25°	FV90V-6DK.C7.25.G	150633	FV90V-6DK.C7.25.H	150634	399	280	59
	30°	FV90V-6DK.D7.30.G	150637	FV90V-6DK.D7.30.H	150638	424	280	62
	35°	FV90V-6DK.F7.35.G	150685	FV90V-6DK.F7.35.H	150686	488	400	87
	40°	FV90V-6DK.F7.40.G	150645	FV90V-6DK.F7.40.H	150646	488	400	87
	45°	FV90V-6DK.G7.45.G	150649	FV90V-6DK.G7.45.H	150650	562	400	98
F	25°	FV90V-6DF.C7.25.G	150635	FV90V-6DF.C7.25.H	150636	---	500	74
	30°	FV90V-6DF.D7.30.G	150639	FV90V-6DF.D7.30.H	150640	---	500	76
	35°	FV90V-6DF.F7.35.G	150687	FV90V-6DF.F7.35.H	150688	---	540	94
	40°	FV90V-6DF.F7.40.G	150647	FV90V-6DF.F7.40.H	150648	---	540	94
	45°	FV90V-6DF.G7.45.G	150651	FV90V-6DF.G7.45.H	150652	---	700	116

Increased Temperature Range : -30°C / +60°C

FV90V-8D



50Hz Motor	U	I	P ₂	n	
	V	A	kW	min ⁻¹	
25°	90 S	400	1,14	0,37*	675
30°	90 L	400	1,58	0,55*	675
35°	100 L	400	2,8	0,75*	725
40°	100 L	400	4,1	1,1*	725
45°	100 L	400	4,1	1,1*	725

*out of IE2 standard scope

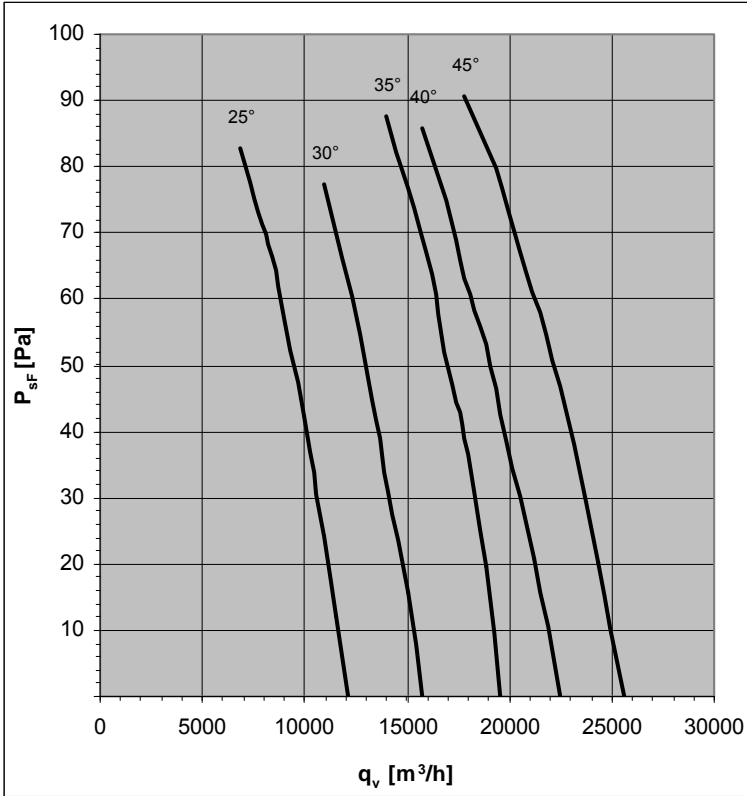

Design K

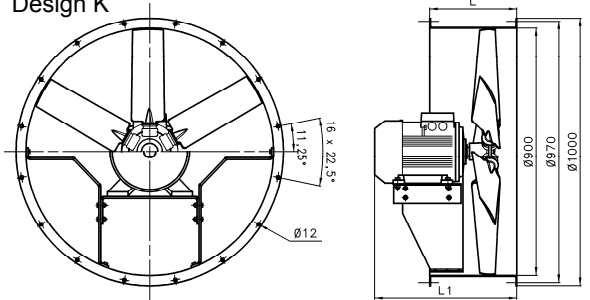

Design F

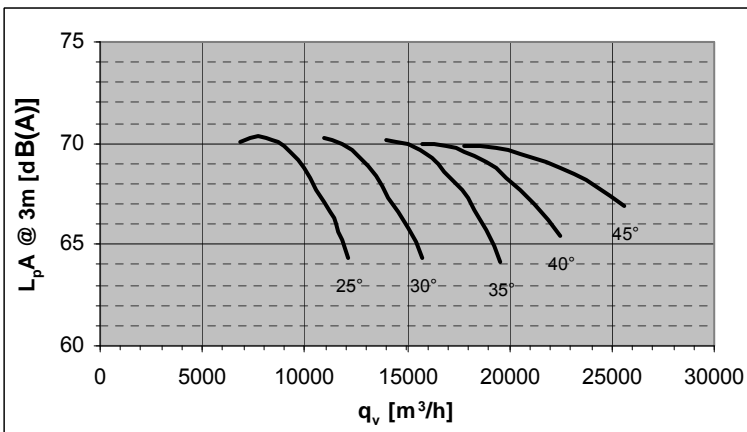
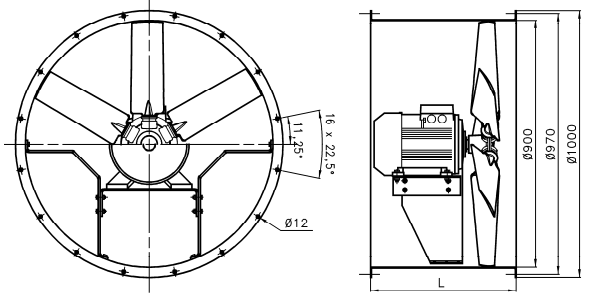

Pitch Angle	Relative spectrum LW dB(A)							
	63	125	250	500	1000	2000	4000	8000
25°	-41	-32	-14	-7	-4	-6	-10	-20
30°	-40	-31	-14	-7	-4	-5	-10	-19
35°	-39	-30	-14	-7	-4	-5	-9	-18
40°	-38	-30	-15	-7	-4	-5	-9	-17
45°	-38	-29	-15	-7	-4	-5	-8	-16

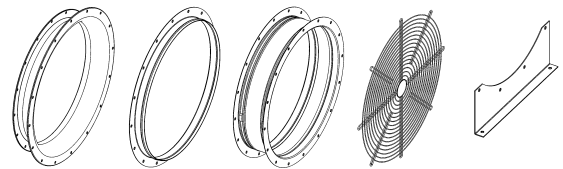

Accessories : see pages 104-106

Design	Pitch Angle	Type (G finish)	Part N°	Type (H finish)	Part N°	L1(mm)	L(mm)	Weight (kg)
K	25°	FV90V-8DK.C7.25.G	150653	FV90V-8DK.C7.25.H	150654	420	280	51
	30°	FV90V-8DK.D7.30.G	150657	FV90V-8DK.D7.30.H	150658	420	280	54
	35°	FV90V-8DK.E7.35.G	150661	FV90V-8DK.E7.35.H	150662	484	280	62
	40°	FV90V-8DK.E7.40.G	150689	FV90V-8DK.E7.40.H	150690	484	280	66
	45°	FV90V-8DK.E7.45.G	150669	FV90V-8DK.E7.45.H	150670	484	280	66
F	25°	FV90V-8DF.C7.25.G	150655	FV90V-8DF.C7.25.H	150656	---	500	66
	30°	FV90V-8DF.D7.30.G	150659	FV90V-8DF.D7.30.H	150660	---	500	69
	35°	FV90V-8DF.E7.35.G	150663	FV90V-8DF.E7.35.H	150664	---	500	76
	40°	FV90V-8DF.E7.40.G	150691	FV90V-8DF.E7.40.H	150692	---	500	80
	45°	FV90V-8DF.E7.45.G	150671	FV90V-8DF.E7.45.H	150672	---	500	80

FV10V-4D



50Hz Motor	U	I	P ₂	n
	V	A	kW	min ⁻¹
30°	160 M	400	21	1470
35°	160 L	400	28,4	1470
40°	180 M	400	34	1470
45°	180 L	400	39,8	1470
50°	200 L	400	53,9	1470

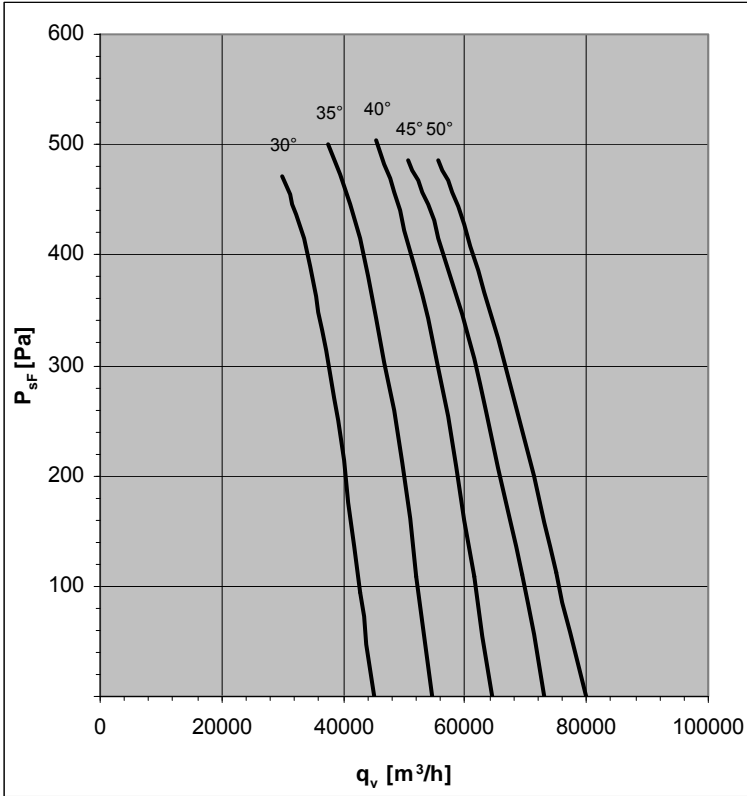

Design K

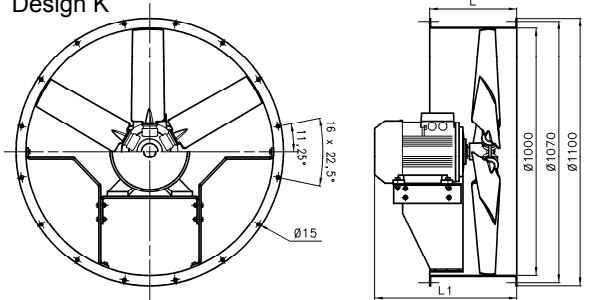

Design F

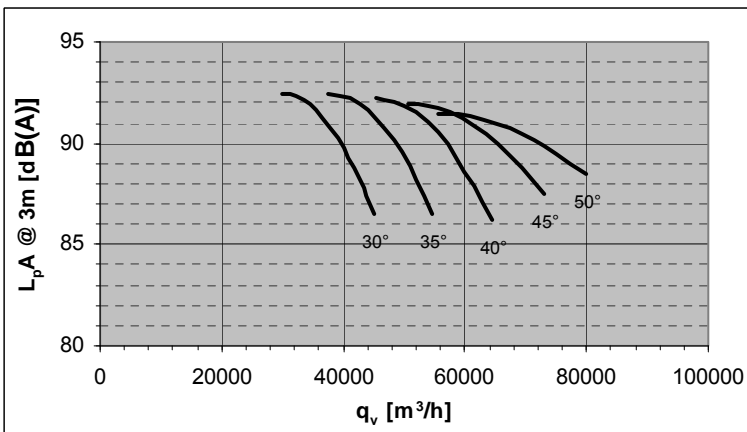
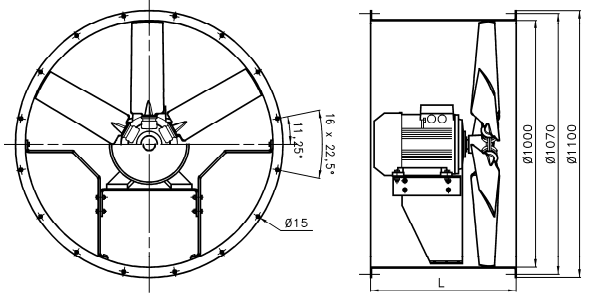

Pitch Angle	Relative spectrum LW dB(A)							
	63	125	250	500	1000	2000	4000	8000
30°	-52	-41	-18	-9	-5	-7	-13	-25
35°	-51	-40	-18	-9	-5	-7	-12	-24
40°	-49	-39	-18	-9	-5	-7	-12	-22
45°	-49	-38	-19	-9	-5	-6	-11	-21
50°	-48	-37	-19	-9	-5	-6	-10	-20

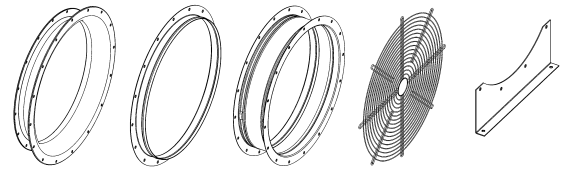

Accessories : see pages 104-106

Design	Pitch Angle	Type (G finish)	Part N°	Type (H finish)	Part N°	L1(mm)	L(mm)	Weight (kg)
K	30°	FV10V-4DK.I7.30.G	150753	FV10V-4DK.I7.30.H	150754	702	400	209
	35°	FV10V-4DK.K7.35.G	150757	FV10V-4DK.K7.35.H	150758	757	400	219
	40°	FV10V-4DK.L7.40.G	150761	FV10V-4DK.L7.40.H	150762	826	450	282
	45°	FV10V-4DK.M7.45.G	150765	FV10V-4DK.M7.45.H	150766	826	450	297
	50°	FV10V-4DK.N7.50.G	150709	FV10V-4DK.N7.50.H	150710	856	450	367
F	30°	FV10V-4DF.I7.30.G	150755	FV10V-4DF.I7.30.H	150756	---	700	231
	35°	FV10V-4DF.K7.35.G	150759	FV10V-4DF.K7.35.H	150760	---	700	241
	40°	FV10V-4DF.L7.40.G	150763	FV10V-4DF.L7.40.H	150764	---	860	313
	45°	FV10V-4DF.M7.45.G	150767	FV10V-4DF.M7.45.H	150768	---	860	328
	50°	FV10V-4DF.N7.50.G	150711	FV10V-4DF.N7.50.H	150712	---	860	398

FV10V-6D



50Hz Motor	U	I	P ₂	n	
	V	A	kW	min ⁻¹	
30°	112 M	400	5,11	2,2	960
35°	132 M	400	8,98	4	960
40°	132 M	400	12	5,5	960
45°	160 M	400	15,9	7,5	970
50°	160 M	400	15,9	7,5	970

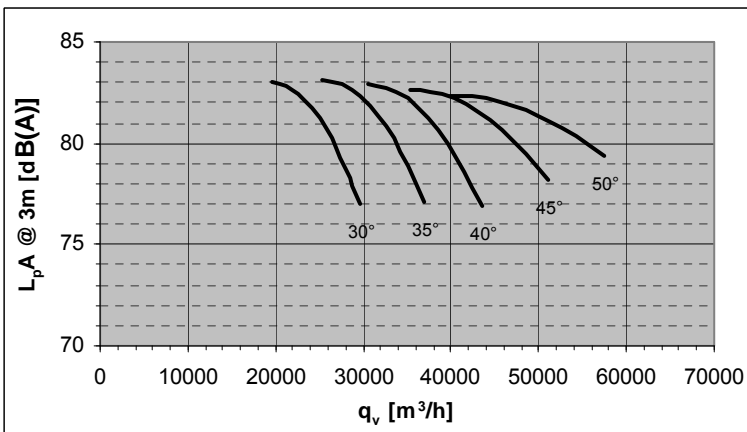
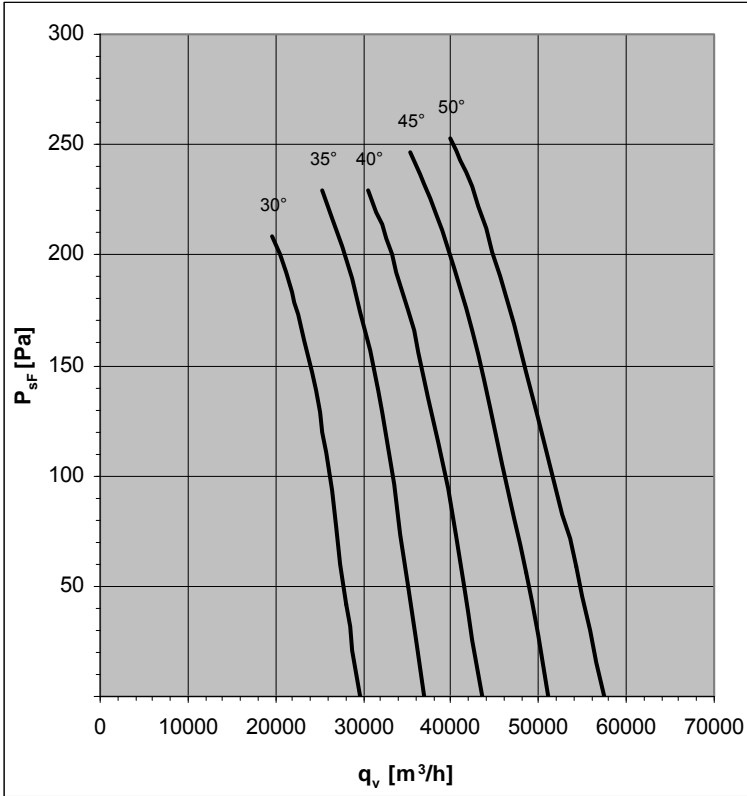

Design K

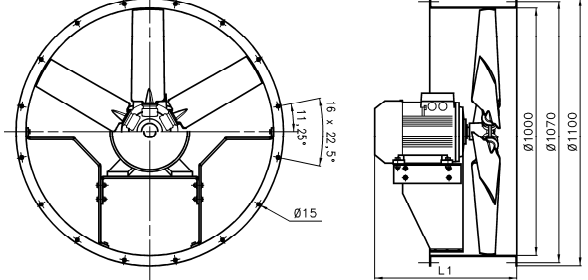

Design F

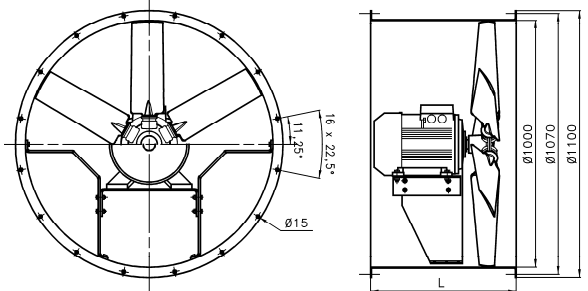

Pitch Angle	Relative spectrum LW dB(A)							
	63	125	250	500	1000	2000	4000	8000
30°	-47	-37	-16	-8	-4	-6	-12	-23
35°	-46	-36	-17	-8	-4	-6	-11	-22
40°	-45	-35	-17	-8	-4	-6	-11	-20
45°	-44	-34	-17	-8	-4	-6	-10	-19
50°	-44	-34	-17	-9	-4	-6	-9	-19

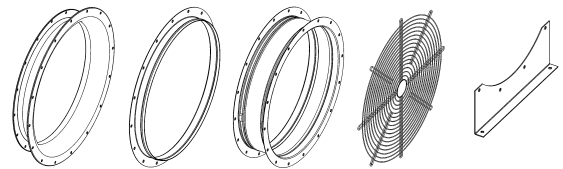

Accessories : see pages 104-106

Design	Pitch Angle	Type (G finish)	Part N°	Type (H finish)	Part N°	L1(mm)	L(mm)	Weight (kg)
K	30°	FV10V-6DK.F7.30.G	150713	FV10V-6DK.F7.30.H	150714	488	400	97
	35°	FV10V-6DK.H7.35.G	150769	FV10V-6DK.H7.35.H	150770	600	400	116
	40°	FV10V-6DK.H7.40.G	150773	FV10V-6DK.H7.40.H	150774	600	400	127
	45°	FV10V-6DK.I7.45.G	150777	FV10V-6DK.I7.45.H	150778	702	400	222
	50°	FV10V-6DK.I7.50.G	150729	FV10V-6DK.I7.50.H	150730	702	400	222
F	30°	FV10V-6DF.F7.30.G	150715	FV10V-6DF.F7.30.H	150716	---	700	119
	35°	FV10V-6DF.H7.35.G	150771	FV10V-6DF.H7.35.H	150772	---	700	139
	40°	FV10V-6DF.H7.40.G	150775	FV10V-6DF.H7.40.H	150776	---	700	149
	45°	FV10V-6DF.I7.45.G	150779	FV10V-6DF.I7.45.H	150780	---	700	244
	50°	FV10V-6DF.I7.50.G	150731	FV10V-6DF.I7.50.H	150732	---	700	244

FV10V-8D



50Hz Motor	U	I	P ₂	n	
	V	A	kW	min ⁻¹	
30°	112 M	400	4,2	1,5*	720
35°	112 M	400	4,2	1,5*	720
40°	132 S	400	6,6	2,2*	725
45°	132 M	400	7,9	3*	730
50°	132 M	400	7,9	3*	730

*out of IE2 standard scope

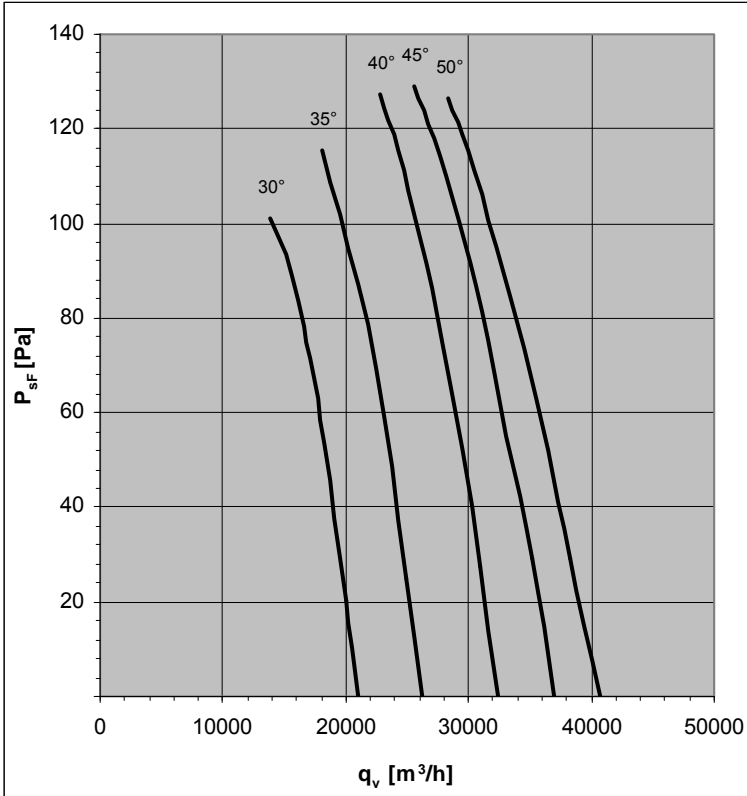

Design K

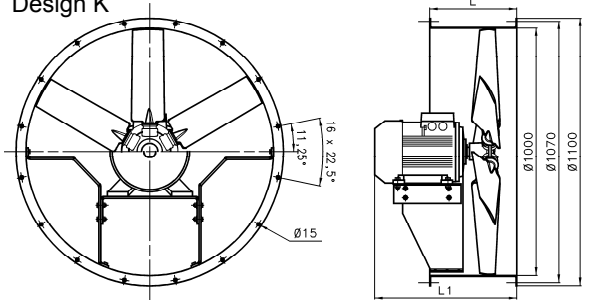

Design F

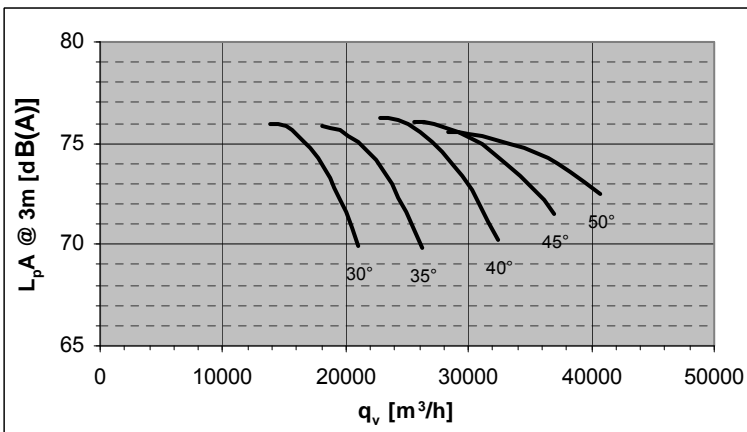
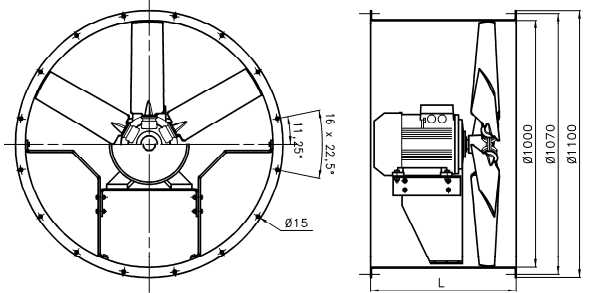

Pitch Angle	Relative spectrum LW dB(A)							
	63	125	250	500	1000	2000	4000	8000
30°	-44	-35	-15	-7	-4	-6	-11	-21
35°	-43	-34	-15	-7	-4	-6	-10	-20
40°	-42	-33	-15	-8	-4	-6	-10	-19
45°	-41	-32	-16	-8	-4	-5	-9	-18
50°	-41	-31	-16	-8	-4	-5	-9	-17

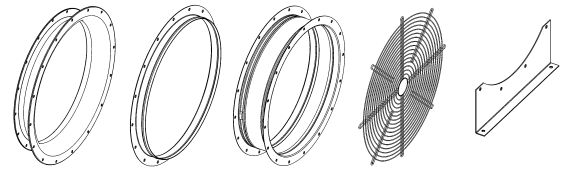

Accessories : see pages 104-106

Design	Pitch Angle	Type (G finish)	Part N°	Type (H finish)	Part N°	L1(mm)	L(mm)	Weight (kg)
K	30°	FV10V-8DK.F7.30.G	150733	FV10V-8DK.F7.30.H	150734	476	400	92
	35°	FV10V-8DK.F7.35.G	150737	FV10V-8DK.F7.35.H	150738	476	400	92
	40°	FV10V-8DK.G7.40.G	150741	FV10V-8DK.G7.40.H	150742	552	400	104
	45°	FV10V-8DK.H7.45.G	150781	FV10V-8DK.H7.45.H	150782	552	400	112
	50°	FV10V-8DK.H7.50.G	150749	FV10V-8DK.H7.50.H	150750	552	400	112
F	30°	FV10V-8DF.F7.30.G	150735	FV10V-8DF.F7.30.H	150736	---	700	115
	35°	FV10V-8DF.F7.35.G	150739	FV10V-8DF.F7.35.H	150740	---	700	115
	40°	FV10V-8DF.G7.40.G	150743	FV10V-8DF.G7.40.H	150744	---	700	127
	45°	FV10V-8DF.H7.45.G	150783	FV10V-8DF.H7.45.H	150784	---	700	135
	50°	FV10V-8DF.H7.50.G	150751	FV10V-8DF.H7.50.H	150752	---	700	135

Increased Temperature Range : -30°C / +60°C

FV12V-4D



50Hz Motor	U	I	P ₂	n	
	V	A	kW	min ⁻¹	
22°	180 L	400	39,8	22	1470
24°	200 L	400	53,9	30	1470
29°	225 S	400	66,2	37	1480
32°	225 M	400	80,2	45	1480
-	-	400	-	-	-

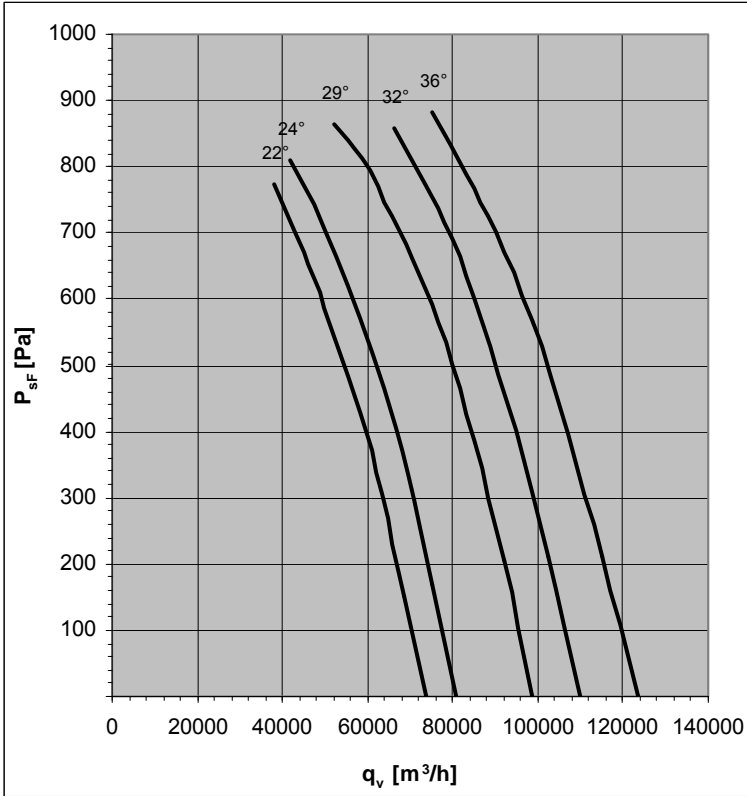

Design K

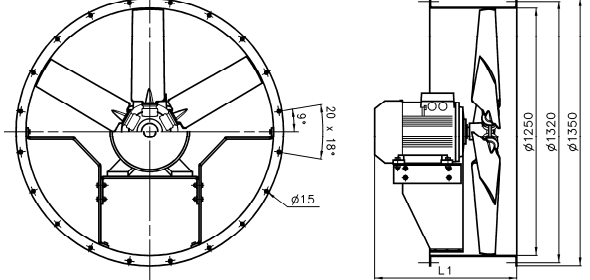

Design F

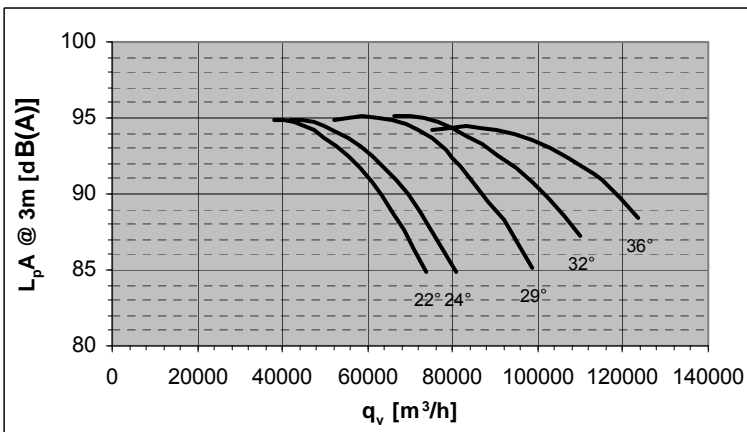
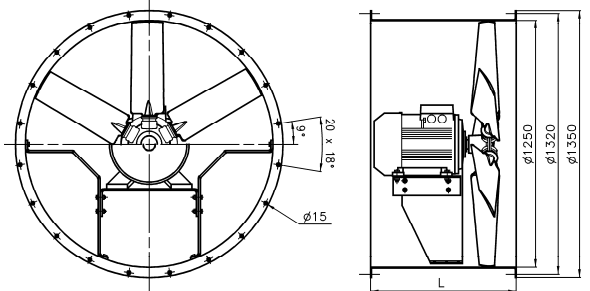

Pitch Angle	Relative spectrum LW dB(A)							
	63	125	250	500	1000	2000	4000	8000
22°	-51	-40	-18	-9	-5	-7	-13	-25
24°	-50	-39	-18	-9	-5	-7	-12	-23
29°	-49	-38	-18	-9	-5	-7	-12	-22
32°	-48	-38	-19	-9	-5	-6	-11	-21
36°	-48	-37	-19	-9	-5	-6	-10	-20

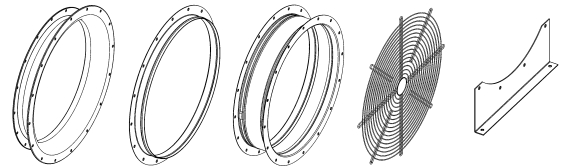

Accessories : see pages 104-106

Design	Pitch Angle	Type (G finish)	Part N°	Type (H finish)	Part N°	L1(mm)	L(mm)	Weight (kg)
K	22°	FV12V-4DK.M7.22.G	150845	FV12V-4DK.M7.22.H	150846	869	500	326
	24°	FV12V-4DK.N7.24.G	150849	FV12V-4DK.N7.24.H	150850	899	500	396
	29°	FV12V-4DK.P7.29.G	150853	FV12V-4DK.P7.29.H	150854	944	500	436
	32°	FV12V-4DK.R7.32.G	150857	FV12V-4DK.R7.32.H	150858	974	500	466
	-	-	-	-	-	---	---	---
F	22°	FV12V-4DF.M7.22.G	150847	FV12V-4DF.M7.22.H	150848	---	1000	366
	24°	FV12V-4DF.N7.24.G	150851	FV12V-4DF.N7.24.H	150852	---	1000	436
	29°	FV12V-4DF.P7.29.G	150855	FV12V-4DF.P7.29.H	150856	---	1000	476
	32°	FV12V-4DF.R7.32.G	150859	FV12V-4DF.R7.32.H	150860	---	1000	506
	-	-	-	-	-	---	---	---

FV12V-6D



50Hz Motor	U	I	P ₂	n	
	V	A	kW	min ⁻¹	
23°	160 M	400	15,9	7,5	970
27°	160 L	400	22,7	11	970
34°	180 L	400	29,4	15	970
39°	200 L	400	36,5	18,5	970
43°	200 L	400	43,1	22	970

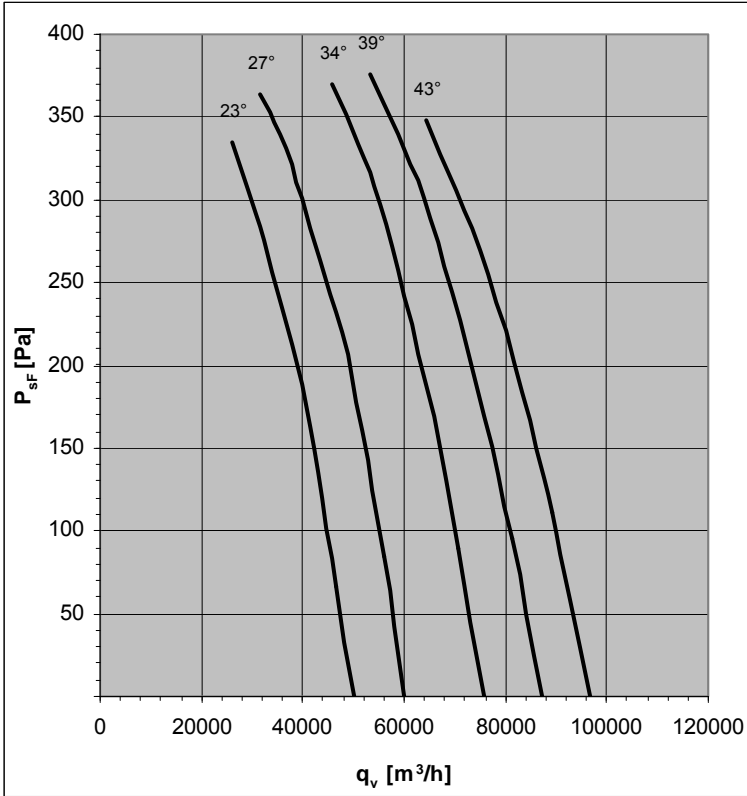

Design K

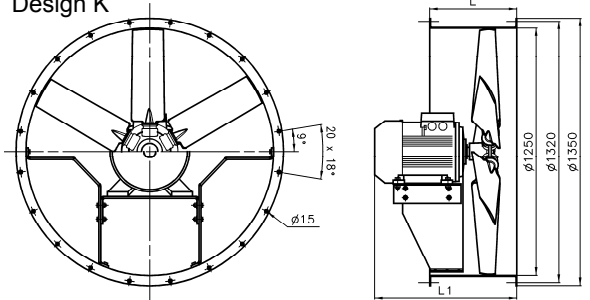

Design F

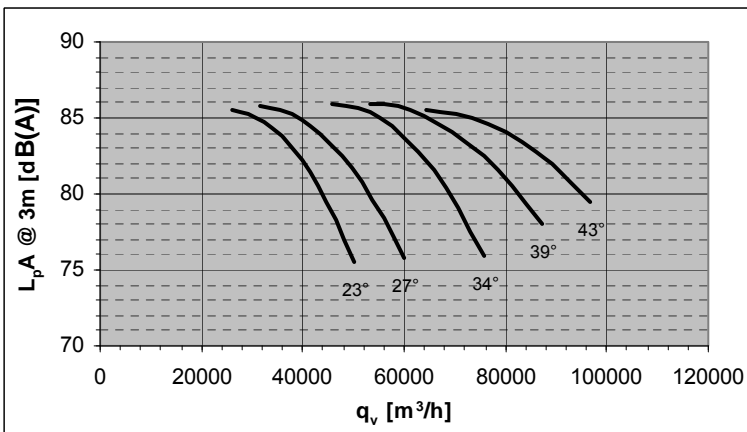
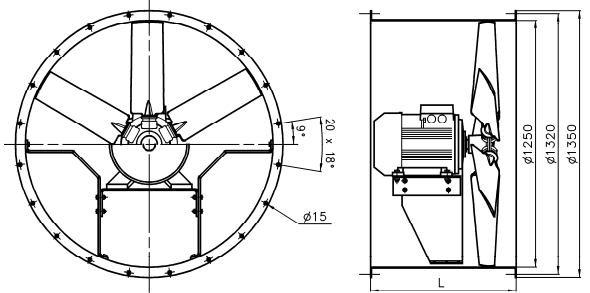

Pitch Angle	Relative spectrum LW dB(A)							
	63	125	250	500	1000	2000	4000	8000
23°	-47	-37	-16	-8	-4	-6	-12	-22
27°	-45	-36	-16	-8	-4	-6	-11	-21
34°	-44	-35	-17	-8	-4	-6	-10	-20
39°	-44	-34	-17	-8	-4	-6	-10	-19
43°	-44	-34	-17	-9	-4	-6	-9	-19

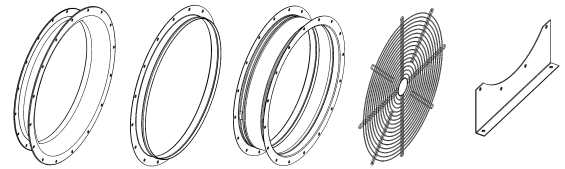

Accessories : see pages 104-106

Design	Pitch Angle	Type (G finish)	Part N°	Type (H finish)	Part N°	L1(mm)	L(mm)	Weight (kg)
K	23°	FV12V-6DK.I7.23.G	150861	FV12V-6DK.I7.23.H	150862	764	500	251
	27°	FV12V-6DK.K7.27.G	150865	FV12V-6DK.K7.27.H	150866	819	500	267
	34°	FV12V-6DK.M7.34.G	150869	FV12V-6DK.M7.34.H	150870	869	500	324
	39°	FV12V-6DK.N7.39.G	150873	FV12V-6DK.N7.39.H	150874	899	500	362
	43°	FV12V-6DK.N7.43.G	150877	FV12V-6DK.N7.43.H	150878	899	500	377
F	23°	FV12V-6DF.I7.23.G	150863	FV12V-6DF.I7.23.H	150864	---	760	274
	27°	FV12V-6DF.K7.27.G	150867	FV12V-6DF.K7.27.H	150868	---	760	290
	34°	FV12V-6DF.M7.34.G	150871	FV12V-6DF.M7.34.H	150872	---	1000	364
	39°	FV12V-6DF.N7.39.G	150875	FV12V-6DF.N7.39.H	150876	---	1000	402
	43°	FV12V-6DF.N7.43.G	150879	FV12V-6DF.N7.43.H	150880	---	1000	417

Increased Temperature Range : -30°C / +60°C

FV12V-8D



50Hz Motor	U	I	P ₂	n	
	V	A	kW	min ⁻¹	
28°	160 M	400	9,39	4*	720
31°	160 M	400	12,5	5,5*	720
38°	160 L	400	16,8	7,5*	720
43°	180 L	400	23,8	11*	730
50°	200 L	400	31,7	15*	730

*out of IE2 standard scope

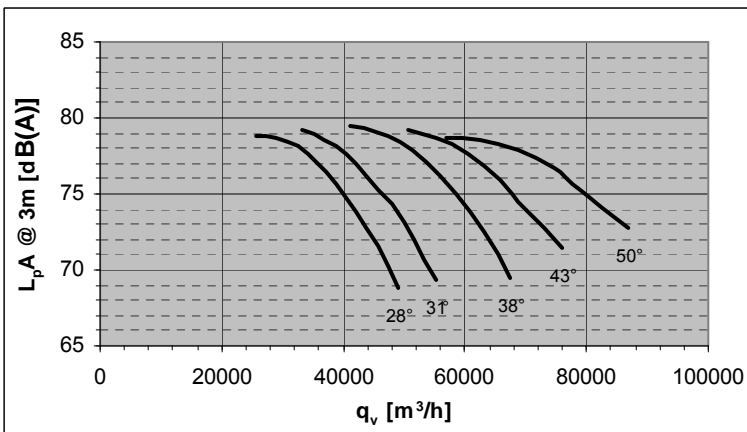
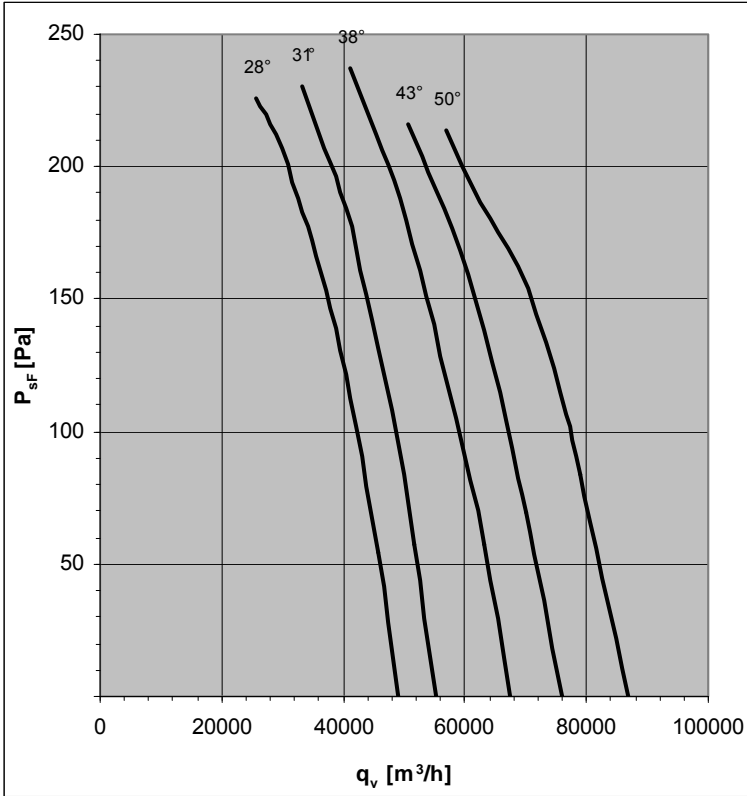

Design K

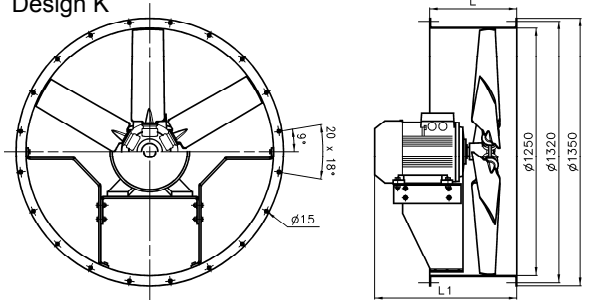

Design F

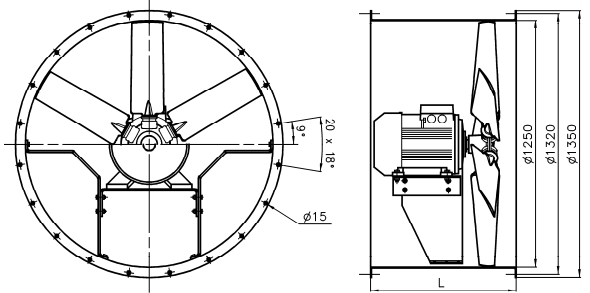

Pitch Angle	Relative spectrum LW dB(A)							
	63	125	250	500	1000	2000	4000	8000
28°	-43	-34	-15	-7	-4	-6	-11	-21
31°	-42	-33	-15	-7	-4	-6	-10	-20
38°	-41	-32	-15	-8	-4	-6	-10	-19
43°	-41	-32	-16	-8	-4	-5	-9	-18
50°	-41	-31	-16	-8	-4	-5	-9	-17

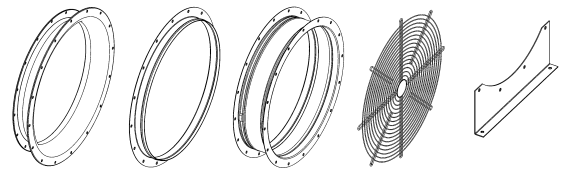

Accessories : see pages 104-106

Design	Pitch Angle	Type (G finish)	Part N°	Type (H finish)	Part N°	L1(mm)	L(mm)	Weight (kg)
K	28°	FV12V-8DK.I7.28.G	150881	FV12V-8DK.I7.28.H	150882	764	500	233
	31°	FV12V-8DK.I7.31.G	150885	FV12V-8DK.I7.31.H	150886	764	500	255
	38°	FV12V-8DK.K7.38.G	150889	FV12V-8DK.K7.38.H	150890	794	500	260
	43°	FV12V-8DK.M7.43.G	150893	FV12V-8DK.M7.43.H	150894	869	500	354
	50°	FV12V-8DK.N7.50.G	150897	FV12V-8DK.N7.50.H	150898	899	500	360
F	28°	FV12V-8DF.I7.28.G	150883	FV12V-8DF.I7.28.H	150884	---	760	256
	31°	FV12V-8DF.I7.31.G	150887	FV12V-8DF.I7.31.H	150888	---	760	278
	38°	FV12V-8DF.K7.38.G	150891	FV12V-8DF.K7.38.H	150892	---	760	283
	43°	FV12V-8DF.M7.43.G	150895	FV12V-8DF.M7.43.H	150896	---	1000	394
	50°	FV12V-8DF.N7.50.G	150899	FV12V-8DF.N7.50.H	150900	---	1000	400

FV14V-6D



50Hz Motor	U	I	P ₂	n	
	V	A	kW	min ⁻¹	
22°	180 L	400	29,4	15	970
27°	200 L	400	36,5	18,5	970
29°	200 L	400	43,1	22	970
32°	225 M	400	56,2	30	980
-	-	400	-	-	-

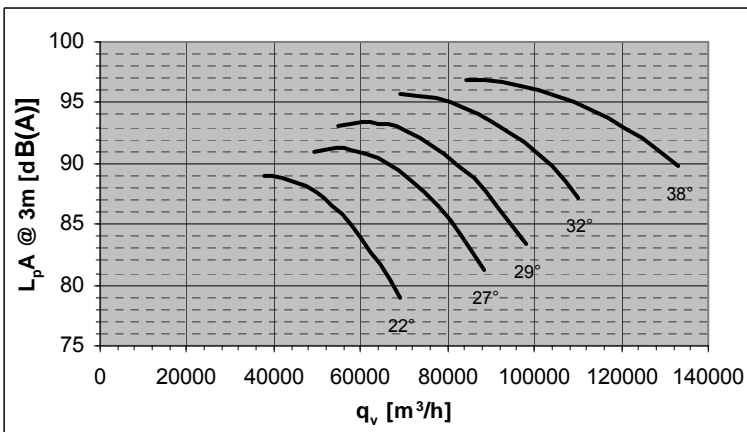
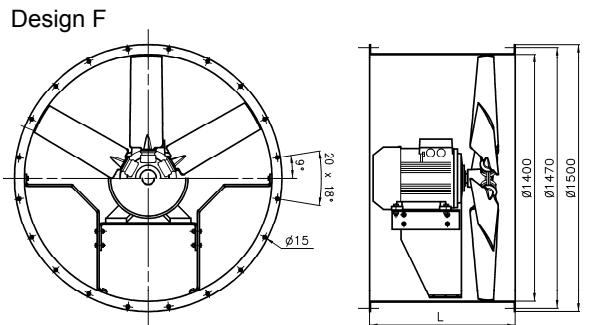
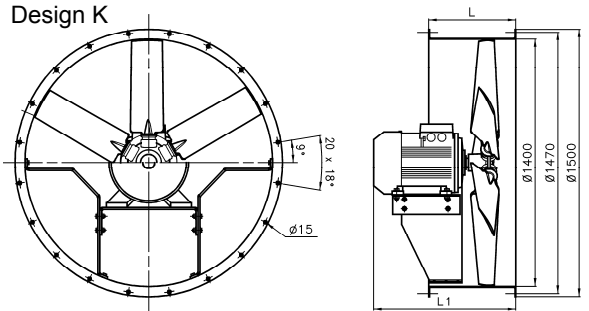
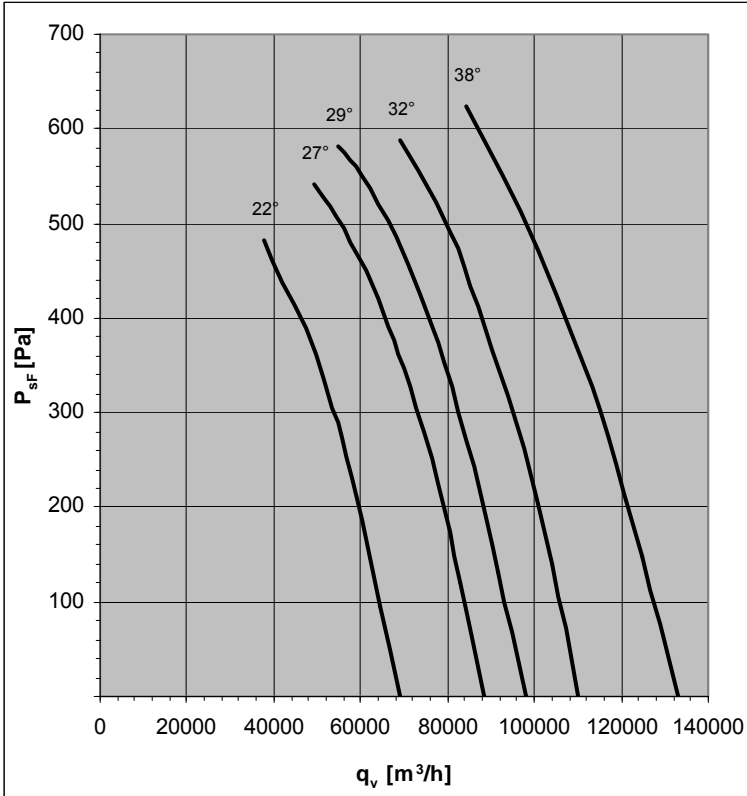

Pitch Angle	Relative spectrum LW dB(A)							
	63	125	250	500	1000	2000	4000	8000
22°	-48	-38	-17	-8	-5	-7	-12	-23
27°	-48	-38	-17	-8	-5	-7	-12	-23
29°	-48	-37	-18	-9	-5	-6	-11	-22
32°	-48	-38	-19	-9	-5	-6	-11	-21
38°	-48	-37	-19	-9	-5	-6	-10	-21

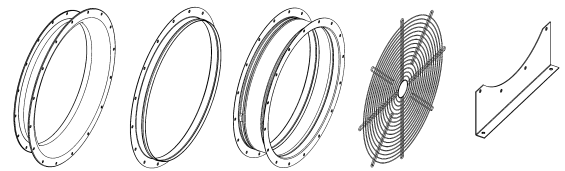

Accessories : see pages 104-106

Design	Pitch Angle	Type (G finish)	Part N°	Type (H finish)	Part N°	L1(mm)	L(mm)	Weight (kg)
K	22°	FV14V-6DK.M7.22.G	150941	FV14V-6DK.M7.22.H	150942	869	500	361
	27°	FV14V-6DK.N7.27.G	150945	FV14V-6DK.N7.27.H	150946	899	500	399
	29°	FV14V-6DK.N7.29.G	150949	FV14V-6DK.N7.29.H	150950	899	500	414
	32°	FV14V-6DK.R7.32.G	150953	FV14V-6DK.R7.32.H	150954	974	500	480
	-	-	-	-	-	---	---	---
F	22°	FV14V-6DF.M7.22.G	150943	FV14V-6DF.M7.22.H	150944	---	1000	420
	27°	FV14V-6DF.N7.27.G	150947	FV14V-6DF.N7.27.H	150948	---	1000	458
	29°	FV14V-6DF.N7.29.G	150951	FV14V-6DF.N7.29.H	150952	---	1000	473
	32°	FV14V-6DF.R7.32.G	150955	FV14V-6DF.R7.32.H	150956	---	1000	539
	-	-	-	-	-	---	---	---

FV14V-8D



50Hz Motor	U	I	P ₂	n	
	V	A	kW	min ⁻¹	
25°	160 L	400	16,8	7,5*	720
30°	180 L	400	23,8	11*	730
36°	200 L	400	31,7	15*	730
42°	225 S	400	38,7	18,5*	730
47°	225 M	400	44,6	22*	730

*out of IE2 standard scope

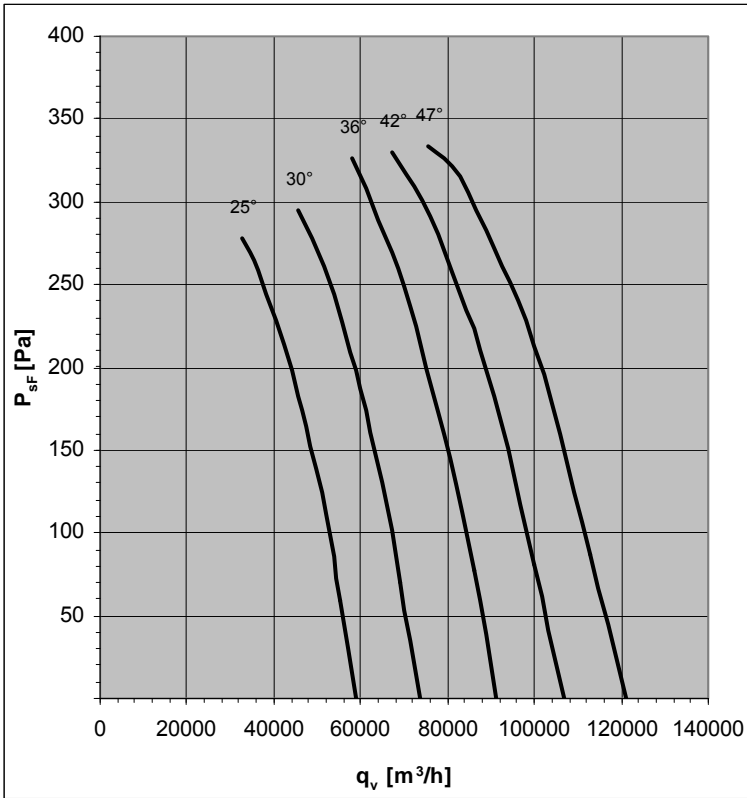

Design K

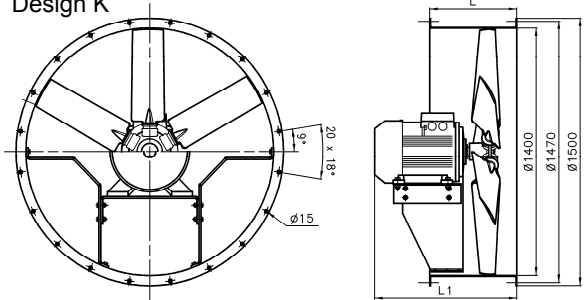

Design F

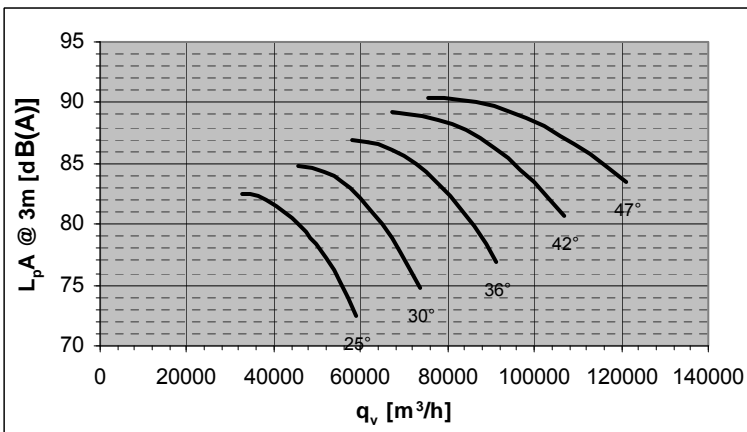
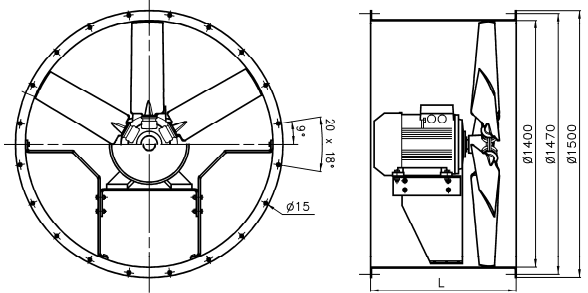

Pitch Angle	Relative spectrum LW dB(A)							
	63	125	250	500	1000	2000	4000	8000
25°	-45	-36	-16	-8	-4	-6	-12	-22
30°	-45	-35	-16	-8	-4	-6	-11	-21
36°	-45	-35	-17	-8	-4	-6	-11	-20
42°	-45	-35	-18	-9	-5	-6	-10	-20
47°	-45	-35	-18	-9	-5	-6	-10	-19

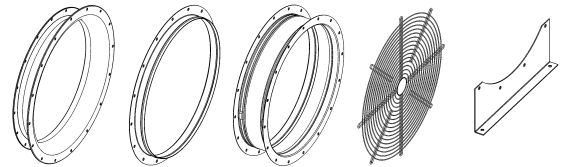

Accessories : see pages 104-106

Design	Pitch Angle	Type (G finish)	Part N°	Type (H finish)	Part N°	L1(mm)	L(mm)	Weight (kg)
K	25°	FV14V-8DK.K7.25.G	150957	FV14V-8DK.K7.25.H	150958	794	500	294
	30°	FV14V-8DK.M7.30.G	150961	FV14V-8DK.M7.30.H	150962	869	500	391
	36°	FV14V-8DK.N7.36.G	150965	FV14V-8DK.N7.36.H	150966	899	500	397
	42°	FV14V-8DK.P7.42.G	150969	FV14V-8DK.P7.42.H	150970	944	500	439
	47°	FV14V-8DK.R7.47.G	150973	FV14V-8DK.R7.47.H	150974	974	500	461
F	25°	FV14V-8DF.K7.25.G	150959	FV14V-8DF.K7.25.H	150960	---	760	329
	30°	FV14V-8DF.M7.30.G	150963	FV14V-8DF.M7.30.H	150964	---	1000	450
	36°	FV14V-8DF.N7.36.G	150967	FV14V-8DF.N7.36.H	150968	---	1000	456
	42°	FV14V-8DF.P7.42.G	150971	FV14V-8DF.P7.42.H	150972	---	1000	498
	47°	FV14V-8DF.R7.47.G	150975	FV14V-8DF.R7.47.H	150976	---	1000	520

Inlet Bellmouth / Virole d'entrée d'air / Einströmdüse / Virolas de entrada de aire

/ Boccagli d'ingresso d'aria

Part N° (G finish)	Part N° (H finish)	Type	ØA	ØB	ØC	ØD	ØE	H
00500107	00500356	FV31	315	355	372	425	395	65
00500354	00500357	FV35	355	395	425	470	450	75
00500108	00500358	FV40	400	450	470	530	500	75
00500355	00500359	FV45	450	500	530	590	560	110
00500109	00500360	FV50	500	560	590	650	620	110
00500110	00500361	FV56	560	650	620	720	690	110
00500111	00500362	FV63	630	690	720	800	770	110
00500112	00500363	FV71	710	770	800	890	860	115
00500113	00500364	FV80	800	860	890	1000	970	125
00500114	00500365	FV90	900	970	1000	1100	1070	125
00500115	00500366	FV10	1000	1070	1100	1220	1190	150
00500116	00500367	FV12	1250	1320	1350	1500	1470	180
00500117	00500368	FV14	1400	1470	1500	1720	1680	230

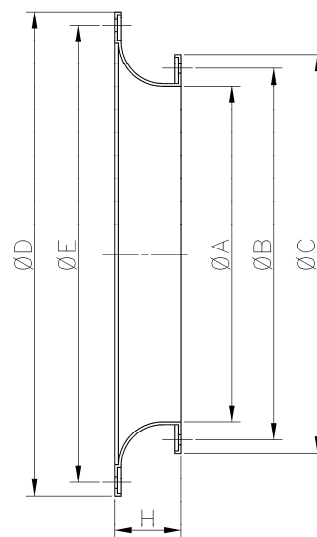

Flexible connector / Virole élastique / Elastischer stutzen / Virolas elásticas / Giunti elastici

Part N° (G finish)	Part N° (H finish)	Type	ØB	ØE	n x Ød	α	H
00500424	00500437	FV31	372	355	8 x Ø10	45°	120
00500425	00500438	FV35	425	395	8 x Ø10	45°	120
00500426	00500439	FV40	470	450	8 x Ø12	45°	120
00500427	00500440	FV45	530	500	8 x Ø12	45°	120
00500428	00500441	FV50	590	560	12 x Ø12	30°	120
00500429	00500442	FV56	650	620	12 x Ø12	30°	150
00500430	00500443	FV63	720	690	12 x Ø12	30°	150
00500431	00500444	FV71	800	770	16 x Ø12	22.5°	150
00500432	00500445	FV80	890	860	16 x Ø12	22.5°	150
00500433	00500446	FV90	1000	970	16 x Ø15	22.5°	180
00500434	00500447	FV10	1100	1070	16 x Ø15	22.5°	180
00500435	00500448	FV12	1350	1320	20 x Ø15	18°	180
00500436	00500449	FV14	1500	1470	20 x Ø15	18°	180

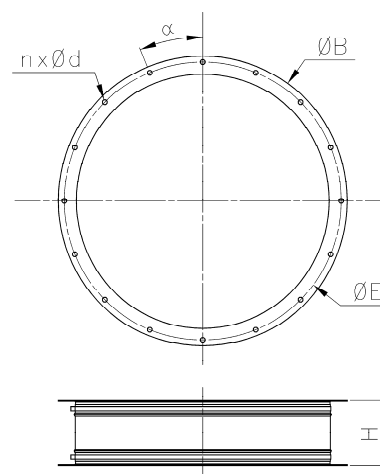

Matching flange / Contre-bride / Gegenflansche / Contrabridas / Contro-flange

Part N° (G finish)	Part N° (H finish)	Type	ØB	ØE	n x Ød	α	H
00500118	00500340	FV31	372	355	8 x Ø10	45°	35
00500093	00500341	FV35	425	395	8 x Ø10	45°	35
00500119	00500342	FV40	470	450	8 x Ø12	45°	35
00500339	00500343	FV45	530	500	8 x Ø12	45°	35
00500120	00500344	FV50	590	560	12 x Ø12	30°	35
00500121	00500345	FV56	650	620	12 x Ø12	30°	35
00500122	00500346	FV63	720	690	12 x Ø12	30°	50
00500123	00500347	FV71	800	770	16 x Ø12	22.5°	50
00500124	00500348	FV80	890	860	16 x Ø12	22.5°	50
00500125	00500349	FV90	1000	970	16 x Ø15	22.5°	50
00500126	00500350	FV10	1100	1070	16 x Ø15	22.5°	50
00500127	00500351	FV12	1350	1320	20 x Ø15	18°	50
00500128	00500352	FV14	1500	1470	20 x Ø15	18°	50

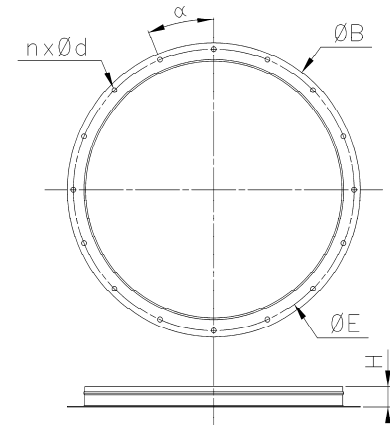

Foot / Pieds / Füße / Patas de montaje / Piedi di montaggio

Part N° (G finish)	Part N° (H finish)	Type	A	B	C	D	ØE	H	H ₁
00500129	00500370	FV31	200	40	150	20	Ø7	200	50
00500094	00500371	FV35	200	40	150	20	Ø7	230	70
00500130	00500372	FV40	330	40	280	20	Ø7	250	80
00500369	00500373	FV45	400	40	350	20	Ø7	280	125
00500131	00500374	FV50	440	60	390	40	Ø12	315	140
00500132	00500375	FV56	480	60	430	40	Ø12	355	155
00500133	00500376	FV63	530	60	480	40	Ø12	400	175
00500134	00500377	FV71	530	60	480	40	Ø18	450	160
00500135	00500378	FV80	530	80	480	50	Ø18	500	160
00500136	00500379	FV90	600	80	550	50	Ø18	560	180
00500137	00500380	FV10	660	80	610	50	Ø18	630	215
00500138	00500381	FV12	1000	80	950	50	Ø18	710	270
00500139	00500382	FV14	1100	80	1050	50	Ø18	800	310

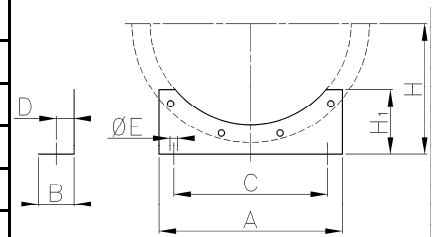

Guard grill / Grille de protection / Schutzgitter / Rejillas de protección / Griglie di protezione

Impeller side

Part N°		Type	ØB	ØC	ØD	E	n x α
Mesh 10mm	Mesh 20mm						
00500140	00500540	FV31	Ø355	Ø310	Ø375	8	4 x 90°
00500141	00500541	FV35	Ø395	Ø370	Ø415	8	4 x 90°
00500142	00500542	FV40	Ø450	Ø410	Ø470	8	4 x 90°
00500143	00500543	FV45	Ø500	Ø470	Ø520	8	4 x 90°
00500144	00500296	FV50	Ø560	Ø510	Ø580	8	4 x 90°
00500145	00500544	FV56	Ø620	Ø570	Ø640	8	4 x 90°
00500146	00500545	FV63	Ø690	Ø650	Ø710	8	4 x 90°
00500147	00500546	FV71	Ø770	Ø710	Ø795	9	8 x 45°
00500148	00500547	FV80	Ø860	Ø810	Ø885	9	8 x 45°
00500149	00500548	FV90	Ø970	Ø910	Ø1010	13	8 x 45°
00500150	00500549	FV10	Ø1070	Ø1010	Ø1100	13	16 x 22.5°
	00500151	FV10+B	Ø1190	Ø1130	Ø1220	13	20 x 18°
00500152	00500550	FV12	Ø1320	Ø1250	Ø1350	13	20 x 18°
00500153	00500551	FV14	Ø1470	Ø1410	Ø1500	13	20 x 18°
	00500154	FV14+B	Ø1680	Ø1610	Ø1710	13	24 x 15°

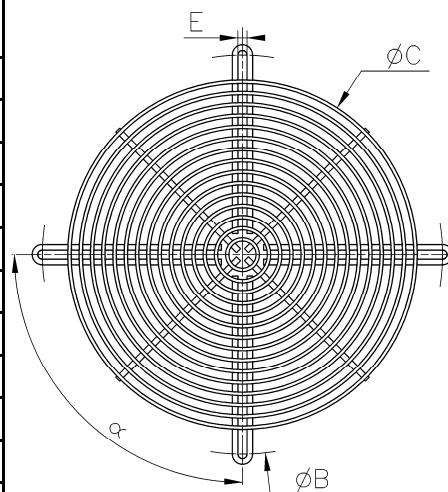

B = Inlet Bellmouth / Virole d'entrée d'air / Einströmdüse / Virolas de entrada de aire / Virole d'ingresso dell'aria

Motor side
Please consult us

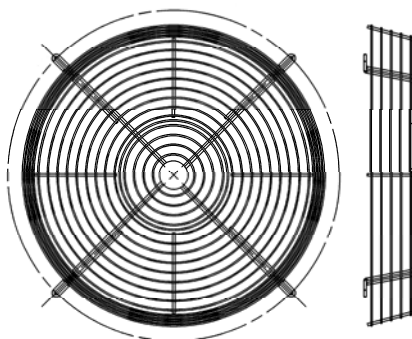

Anti-vibration mounts / Pieds anti-vibration / Schwingungs-dämpfer / Tacos antivibración

/ Giunti anti-vibranti

Part N°		A	B	C	D	ØE	ØF
032017	FV31-45	90	64	40	76	M6	8.2
032018	FV50-63	152	104	40	124	M10	10.2
032019	FV71-14	280	204	40	240	M16	14.2

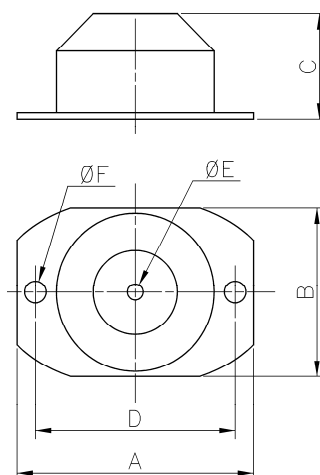

MAXvent AXIAL FAN DEFINITION

Date	<input type="text"/>	Qty of fans per year	<input type="text"/>
Company	<input type="text"/>	Qty of fans per batch	<input type="text"/>
Project	<input type="text"/>		
Application	<input type="text"/>		
Size:	<input type="text"/> mm		
Impeller type	<input type="checkbox"/> PPG: <input type="checkbox"/> PAG^(*) <input type="checkbox"/> ALU		
Explosion-proof:	<input type="checkbox"/>		

Fan Selection:

Air volume	<input type="text"/> m3/h	Expected running time	<input type="text"/> hour/year
Static pressure drop	<input type="text"/> Pa	Expected diameter	<input type="text"/> mm
Airflow temperature	<input type="text"/> °C Max	Expected speed rotation	<input type="text"/> rpm
	<input type="text"/> °C Min	Expected motor power	<input type="text"/> kW
Ambient temperature	<input type="text"/> °C Max	Expected sound level	<input type="text"/> LWA(dbA)
	<input type="text"/> °C Min		
Altitude	<input type="text"/> m		
Relative humidity	<input type="text"/> % at <input type="text"/> C°		

Motor:

Supply voltage	<input type="text"/> V	+/- <input type="checkbox"/> % (+/-5%)	
Frequency	<input type="text"/> Hz	+/- <input type="checkbox"/> % (+/-2%)	
Insulation class	<input type="text"/> F ^(*) or H	<input type="checkbox"/> 3-phase	<input type="checkbox"/> 1-phase
Protection class	<input type="text"/> IP55 ^(*)	<input type="checkbox"/> 1 speed	<input type="checkbox"/> 2 Speeds
Thermal protection	<input type="text"/> PTO / PTC	<input type="checkbox"/> Speed controllable	
Required certificates	<input type="text"/> (CE/UL/CSA/NEMA/others)		
Other option	<input type="text"/>		

Construction and installation (see catalogue drawings):

Casing	<input type="checkbox"/> Long	<input type="checkbox"/> Short	
Motor shaft position	<input type="checkbox"/> Horizontal	<input type="checkbox"/> Up	<input type="checkbox"/> Down
Airflow direction	<input type="checkbox"/> Motor->impeller	<input type="checkbox"/> Impeller->motor	
Number of starts per day	<input type="text"/>		
Specific dimensions	<input type="text"/> (please attach drawing or sketch)		
Surface treatment:	<input type="checkbox"/> Galvanized	<input type="checkbox"/> Hot dip galvanized	Other <input type="text"/>
	<input type="checkbox"/> Paint	RAL <input type="text"/>	Salt fog Capability (h) <input type="text"/>
Environment category (ISO12944)	<input type="text"/>	C1/C2/C3/C4/C5I/C5M	
Required certificates	<input type="text"/>		

Accessories:

<input type="checkbox"/> Bellmouth inlet	<input type="checkbox"/> Set of mounting feet
<input type="checkbox"/> flexible connection	<input type="checkbox"/> Anti-vibrating mounts
<input type="checkbox"/> Matching flange	
<input type="checkbox"/> Impeller side fan guard	<input type="checkbox"/> Speed controller
<input type="checkbox"/> Motor side fan guard	
<input type="checkbox"/> Square top plate (specify dimensions)	

General / Commercial:

Current solution:	<input type="text"/>
Target price:	<input type="text"/>

Other informations:

Duty point conditions : From calculation, existing fan, supplier, measures, catalog, impeller data sheet? Type A,D? Long casing, short casing? With/without inlet cone? With x grids?...

(*) Standard configuration in **bolded characters**

Please refer to the homepage at
www.ziehl-abegg.com
For a list of our subsidiaries worldwide

Ziehl-Abegg FMV S.A.R.L.

Rue de la Gare, BP 8 · F-01800 VILLIEU France
Tél : 33 (0) 474 460 620, Fax : 33 (0) 474 611 958
societe@ziehl-abegg.fr www.ziehl-abegg.fr

ZIEHL-ABEGG 